The image features two architectural cutaway diagrams of a building. The left diagram shows a cross-section of a multi-story structure with a central vertical shaft containing an elevator. A person in a blue uniform stands on a floor level. The right diagram shows a similar cross-section but with a different internal layout, including a staircase and a person standing on a higher floor. A large yellow banner with black text is superimposed over the center of the image.

Vertical Transportation & Structure

Close Up

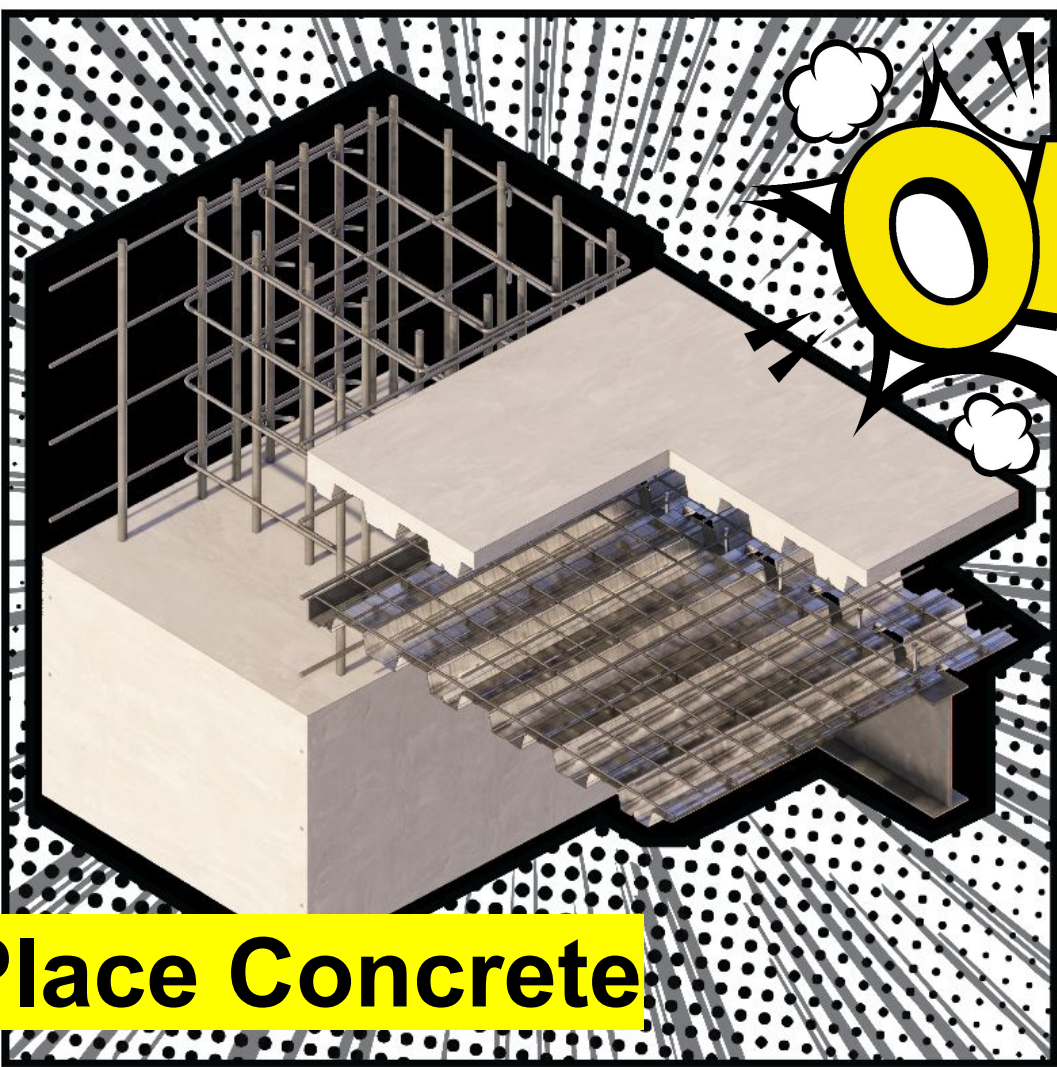

OMG!

Cast In Place Concrete

Cast-in-Place Concrete

Cast-In-Place
Concrete

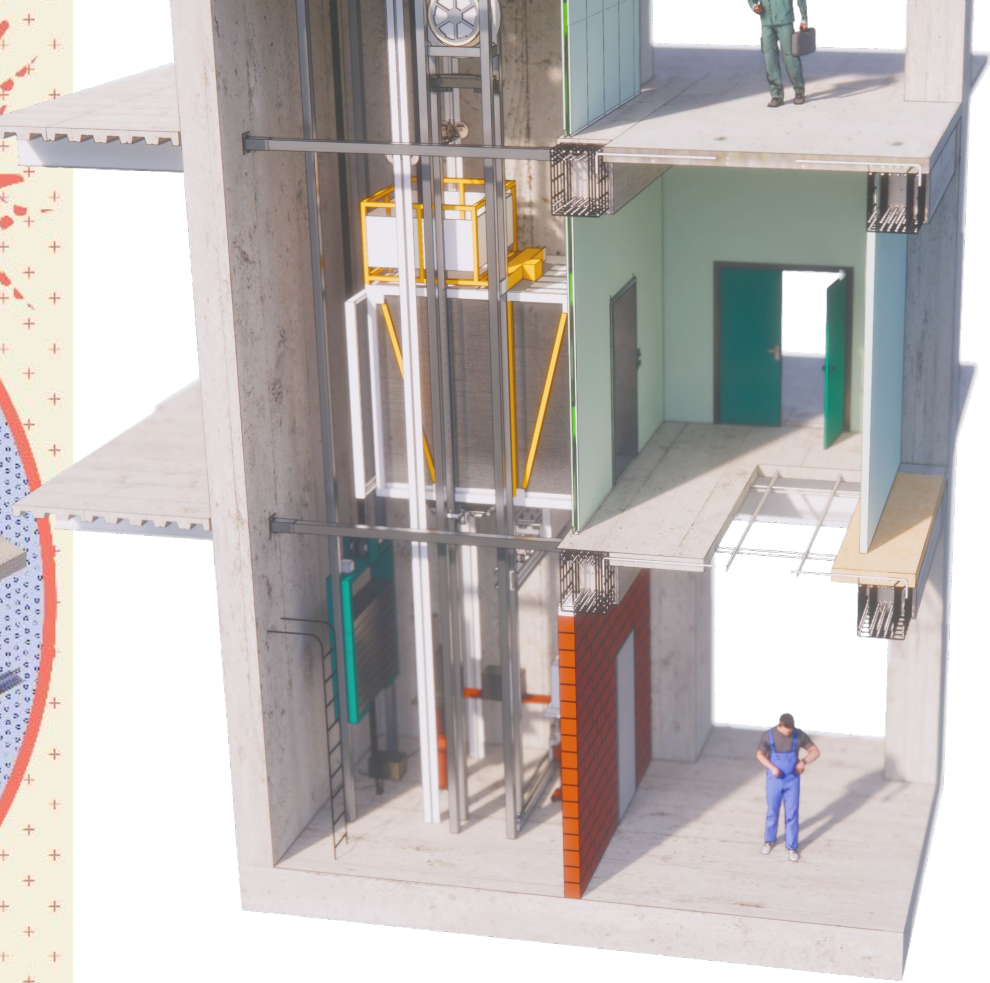
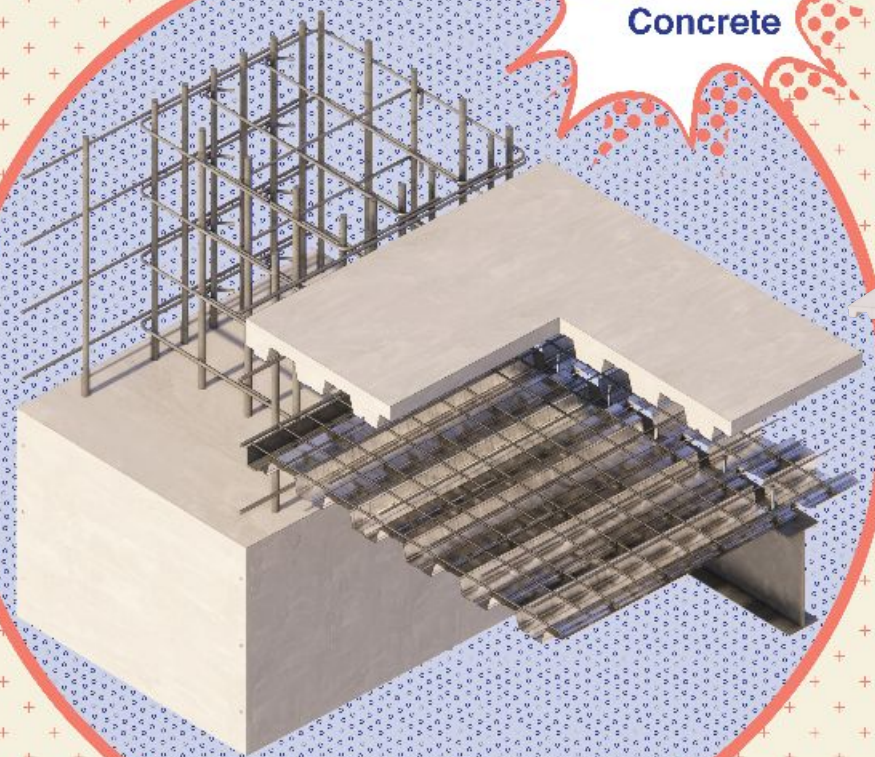

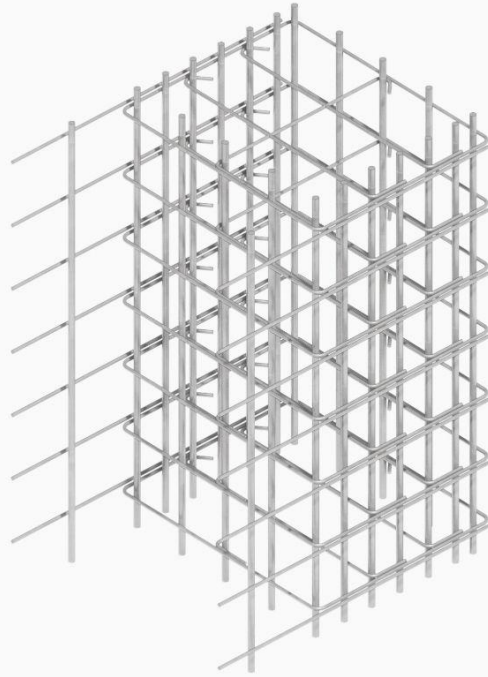

Rebars

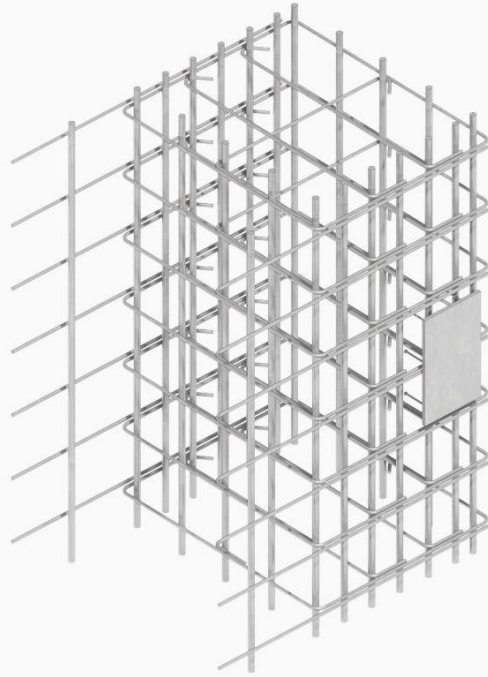
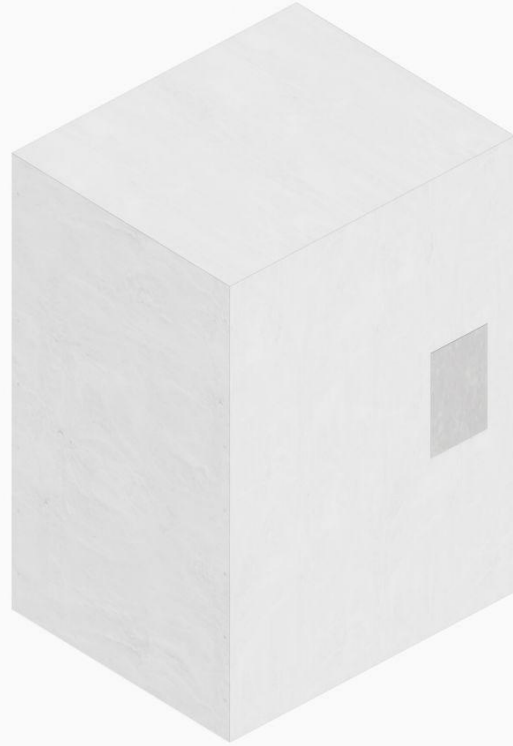
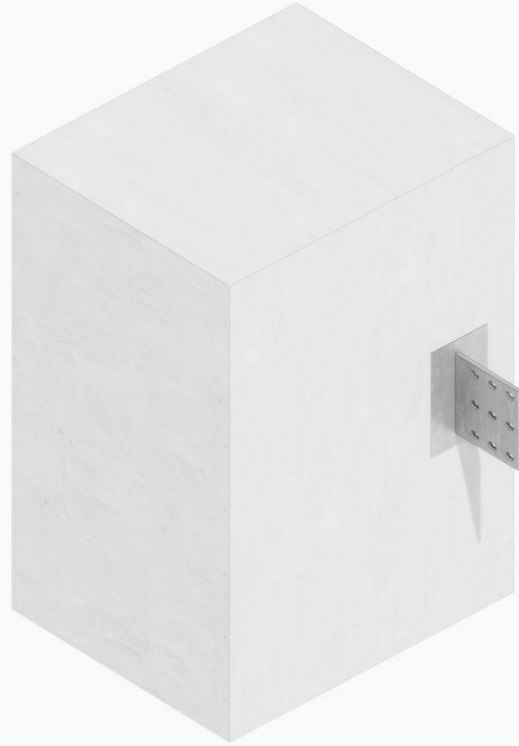

Plate Embed



Concrete Pour



Steel Plate Connection to Beam

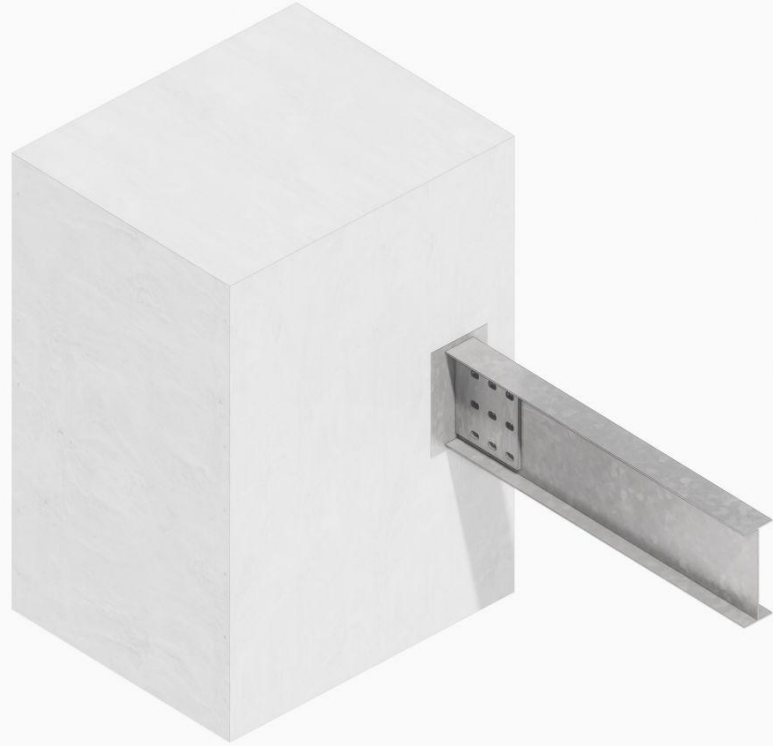

Steel Beam

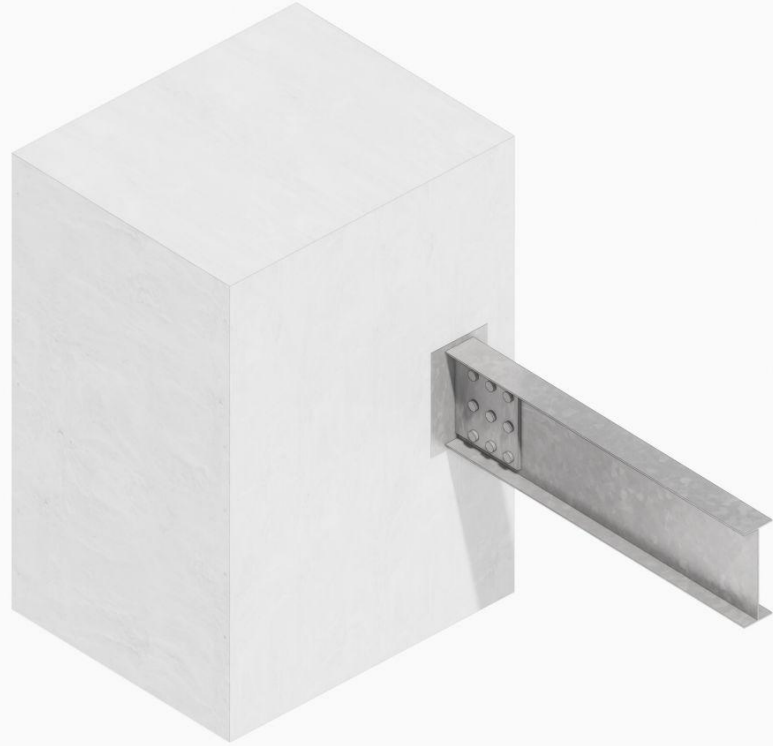

Bolts

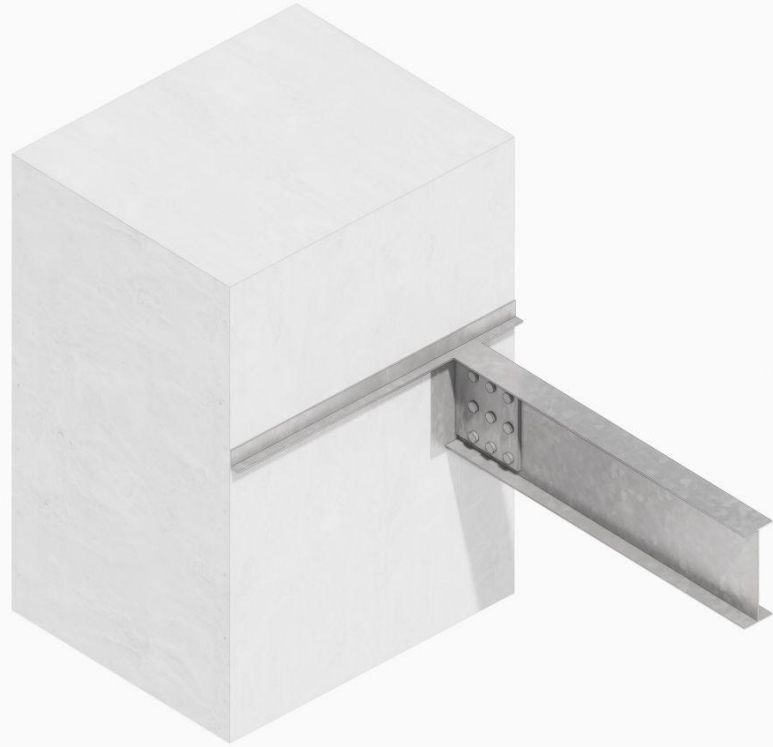

Concrete Pour Stop

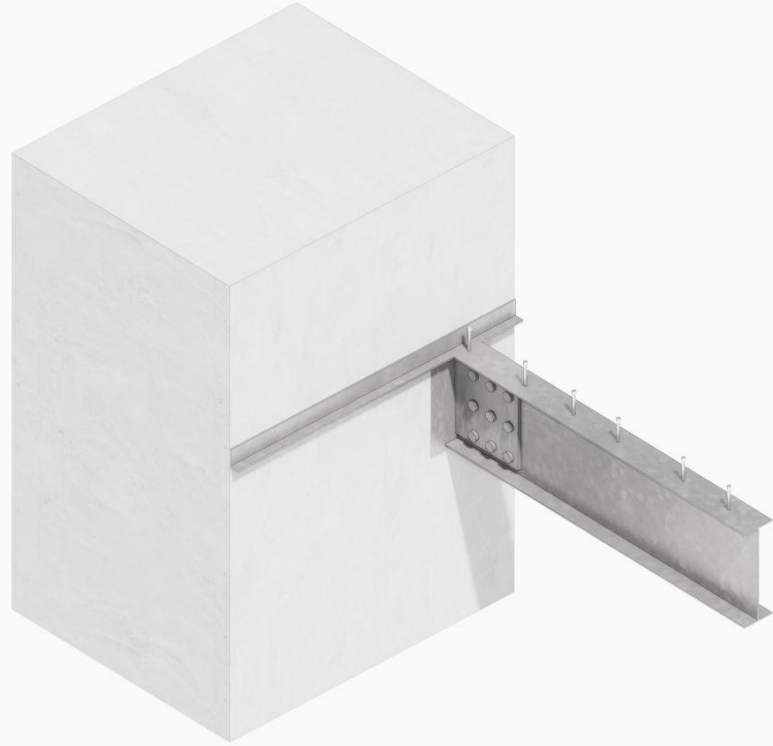

Nails

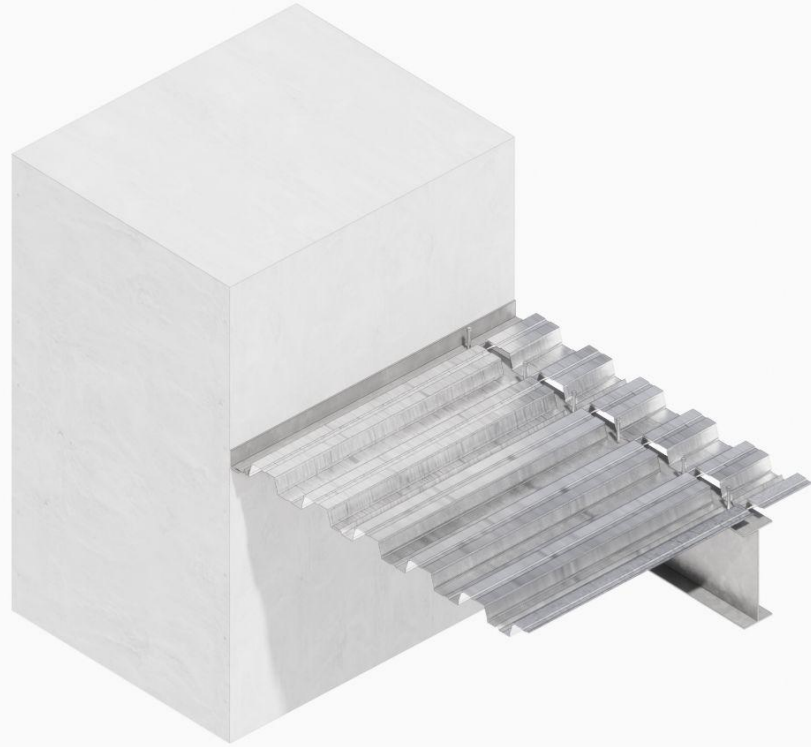

Steel Deck

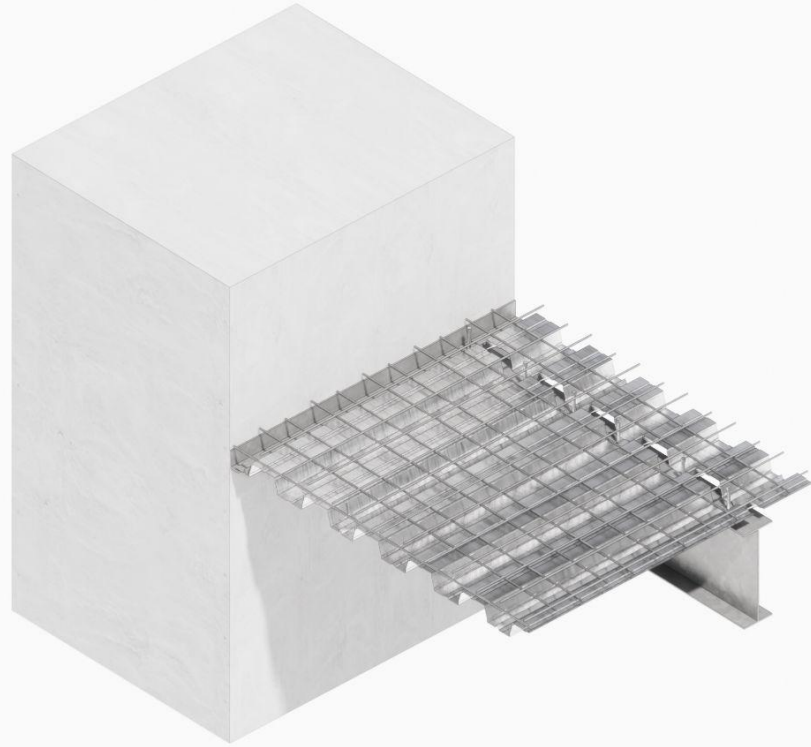

Metal Reinforcing Bar Support

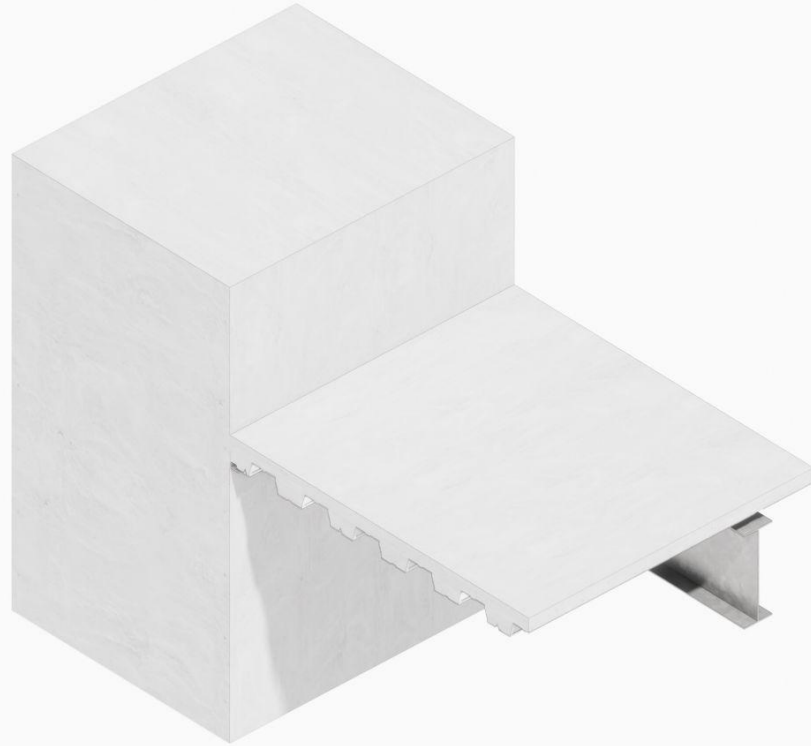

Concrete Pour Above Decking

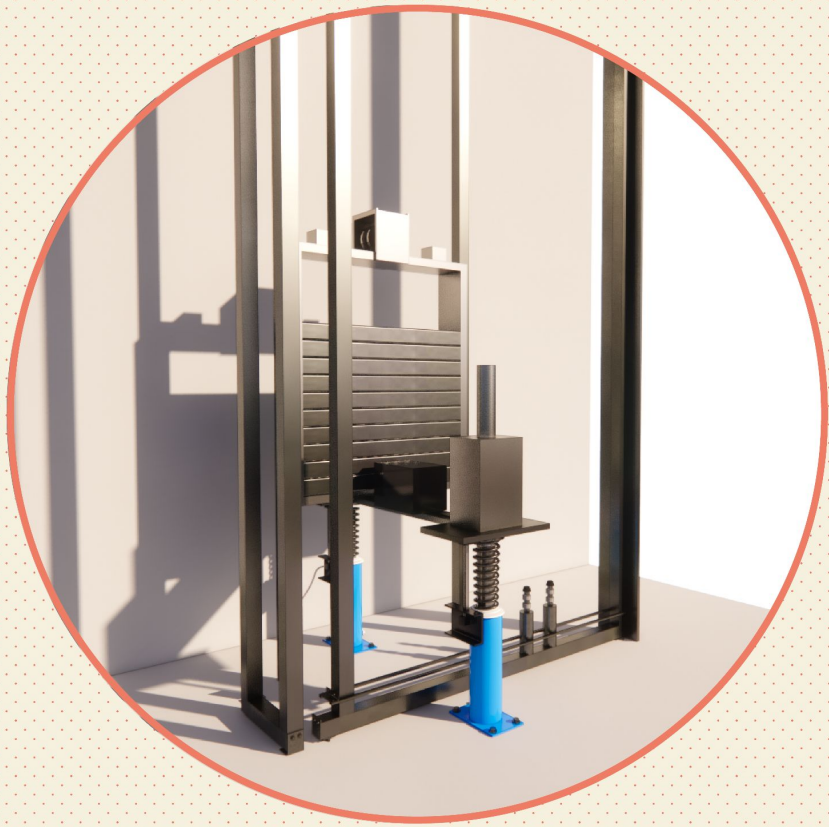

Elevator Pit

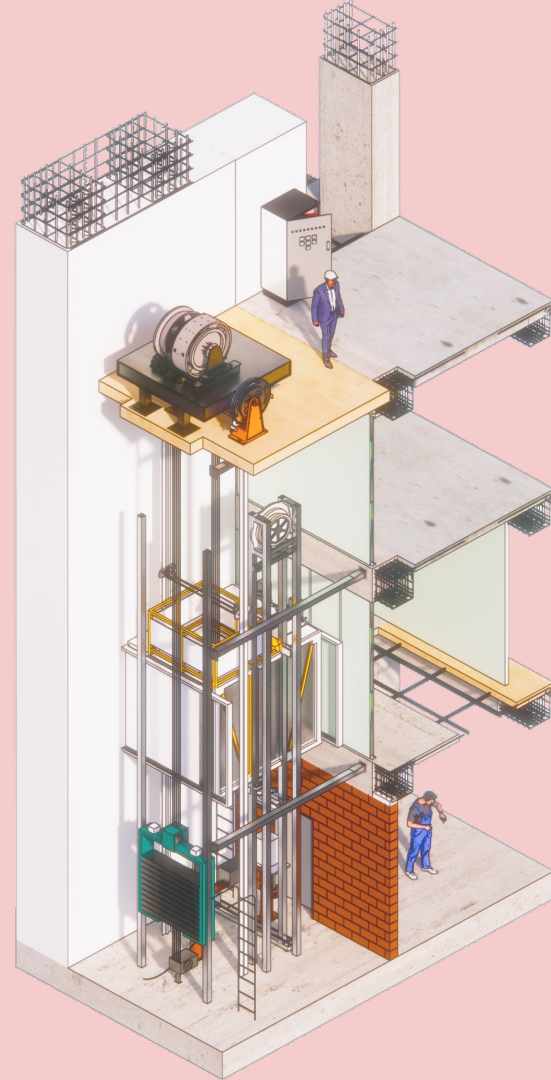

Elevator Pit

Guide Rail Plate
Buffer Channel



Guide Rails
Guide Rail Plate
Buffer Channel



Buffers

Guide Rails

Guide Rail Plate

Buffer Channel

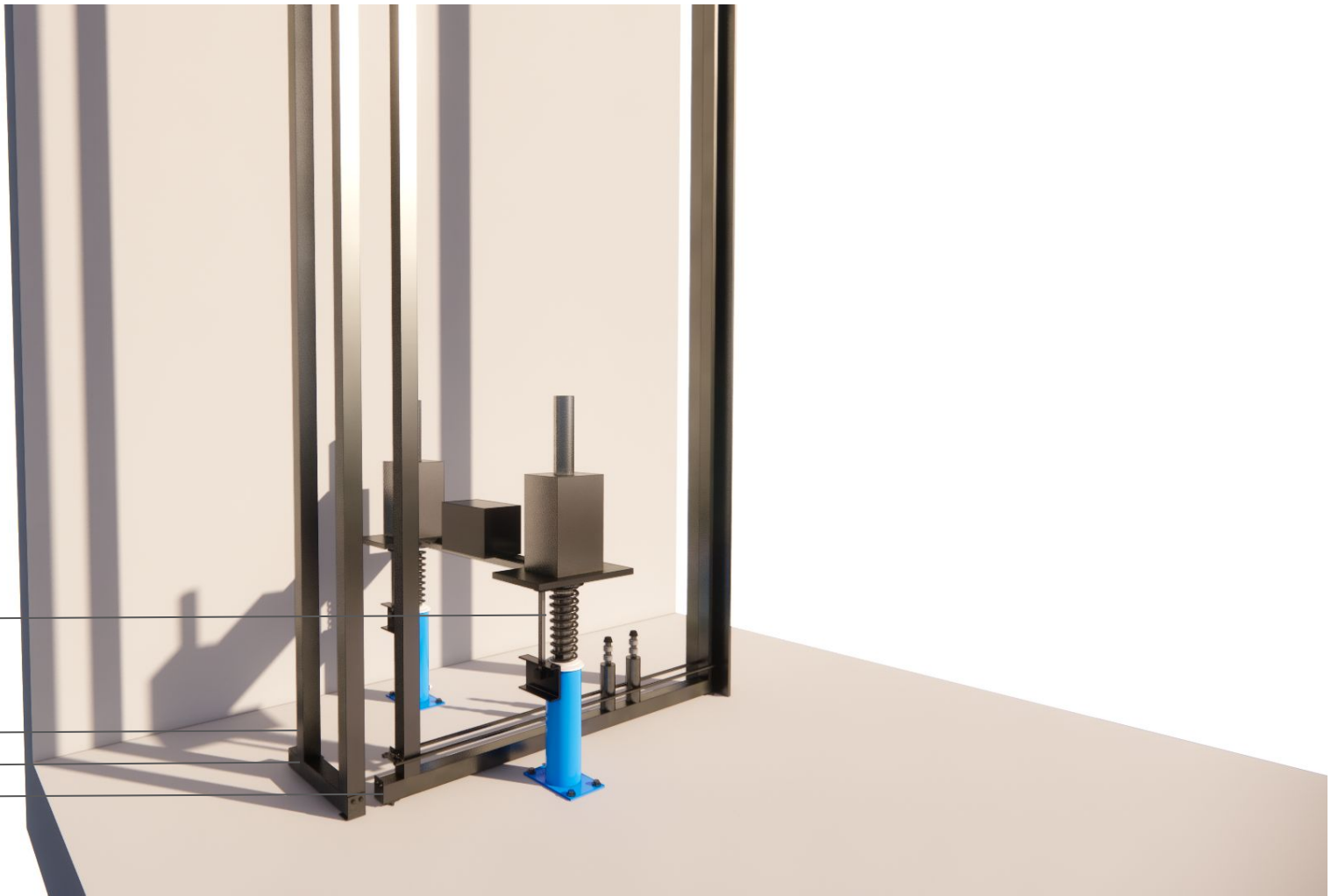

Counterweight

Counterweight
Rails

Buffers

Guide Rails

Guide Rail
Plate

Buffer Channel

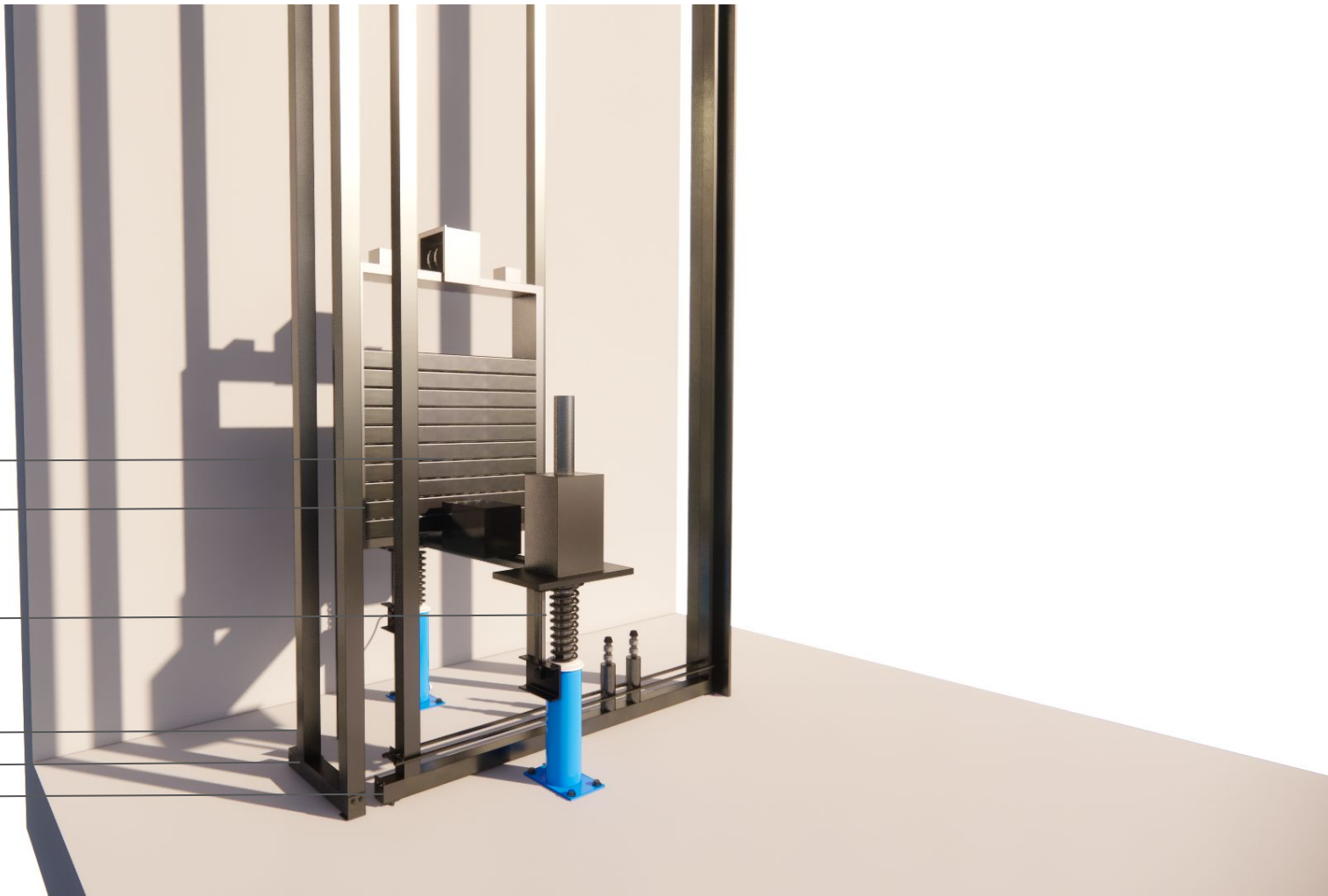

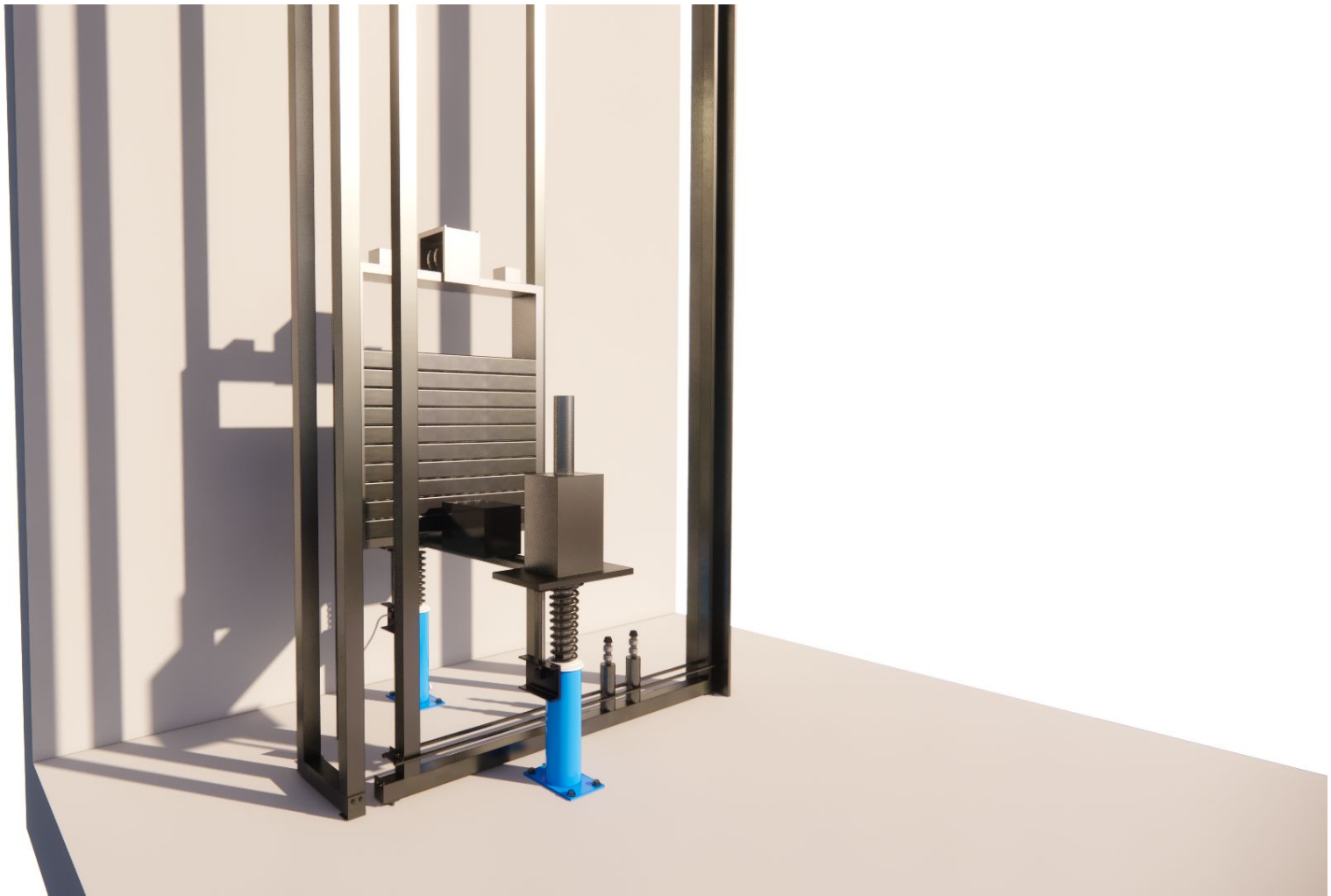

COOL!

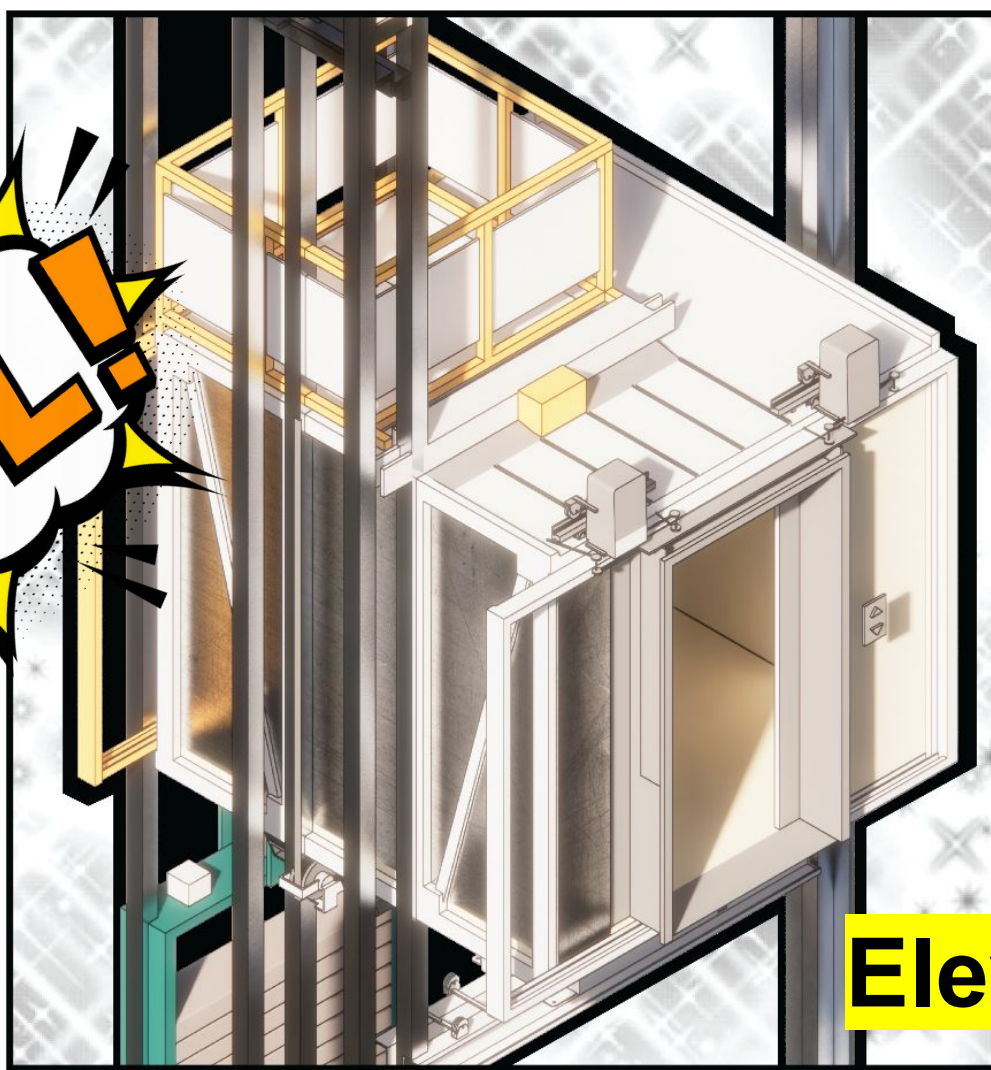

Elevator Cab

**Elevator
Cab
Detail**

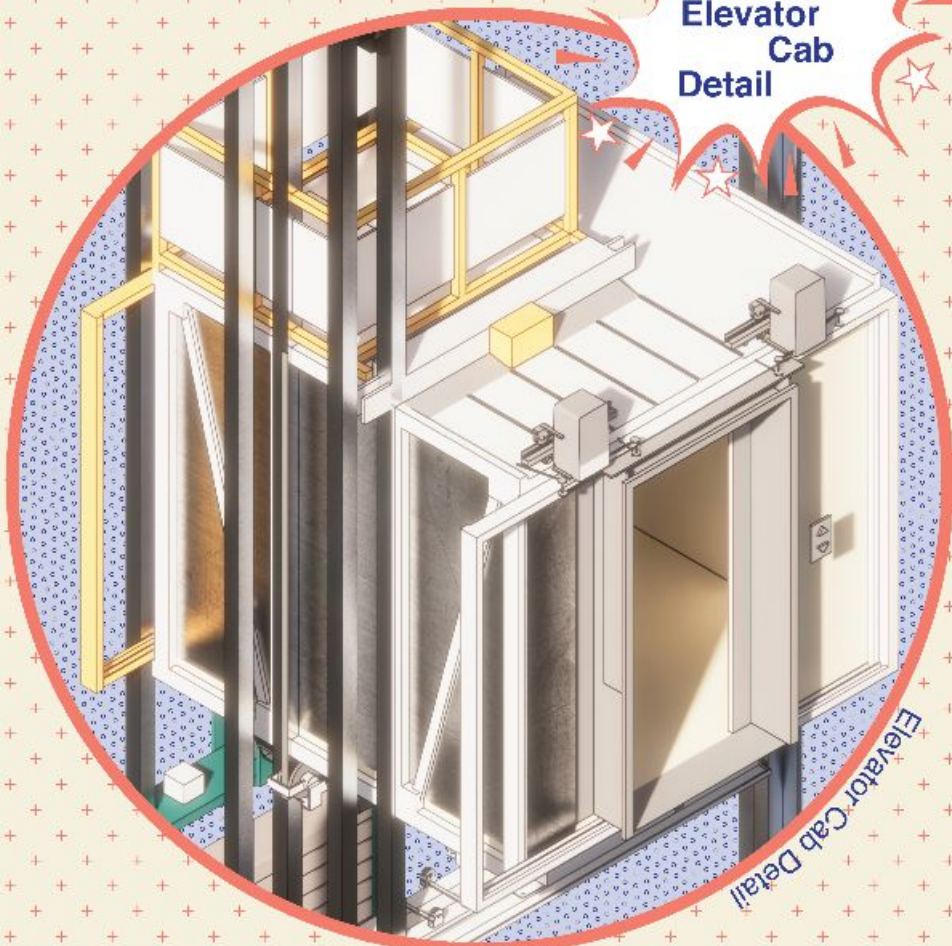

Elevator Cab Detail

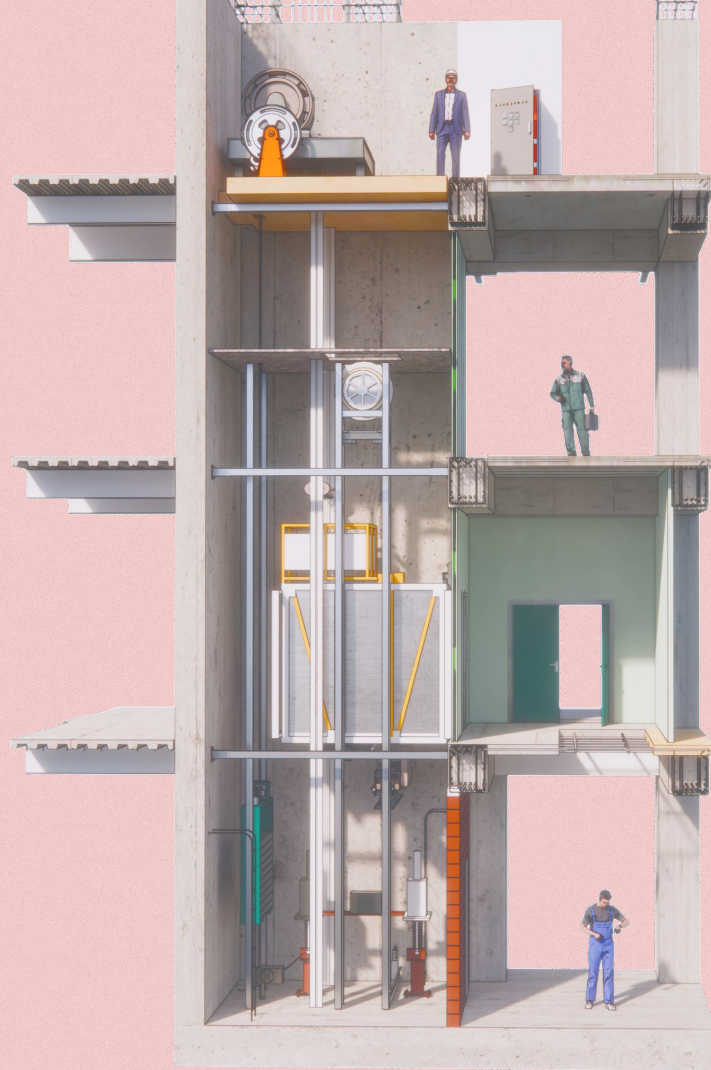

Guide Rail

Safety

Counterweight

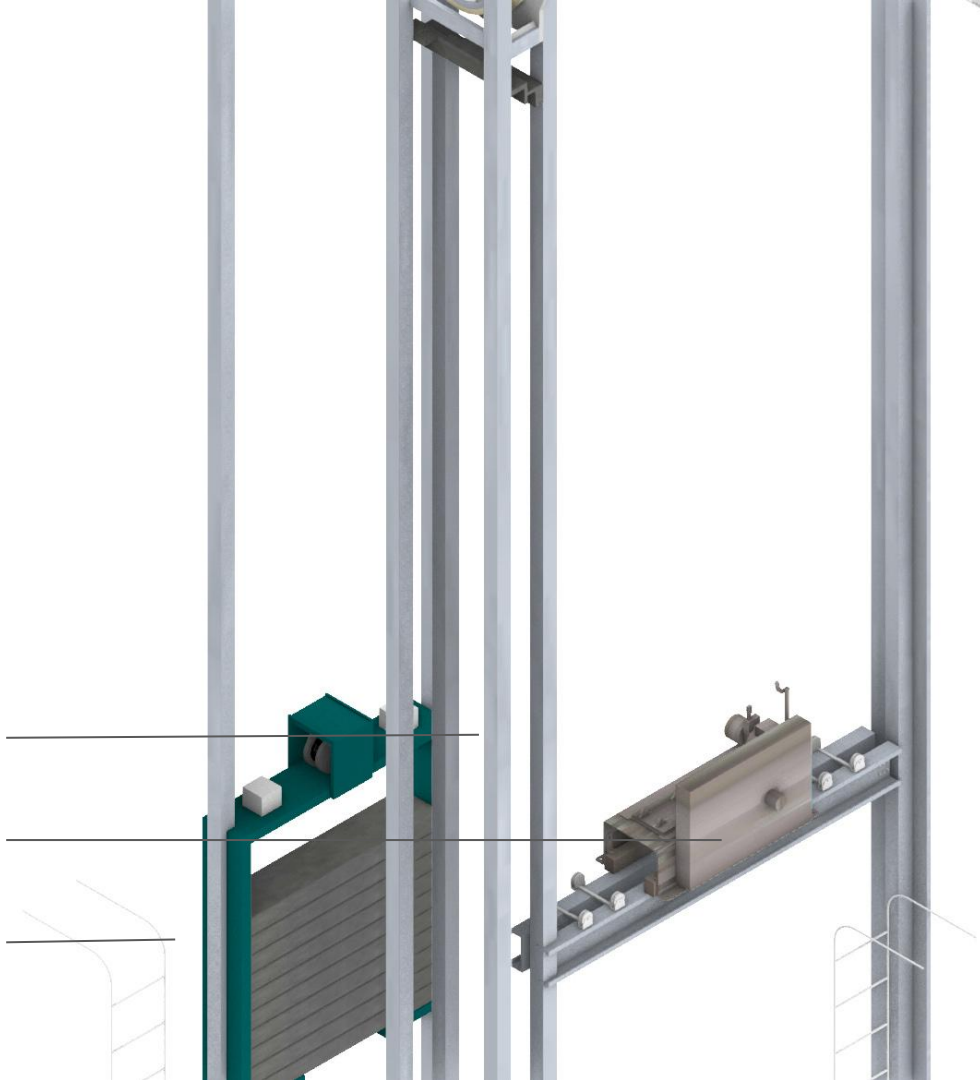

Sling

Car Guide Rail

Safety

Counterweight

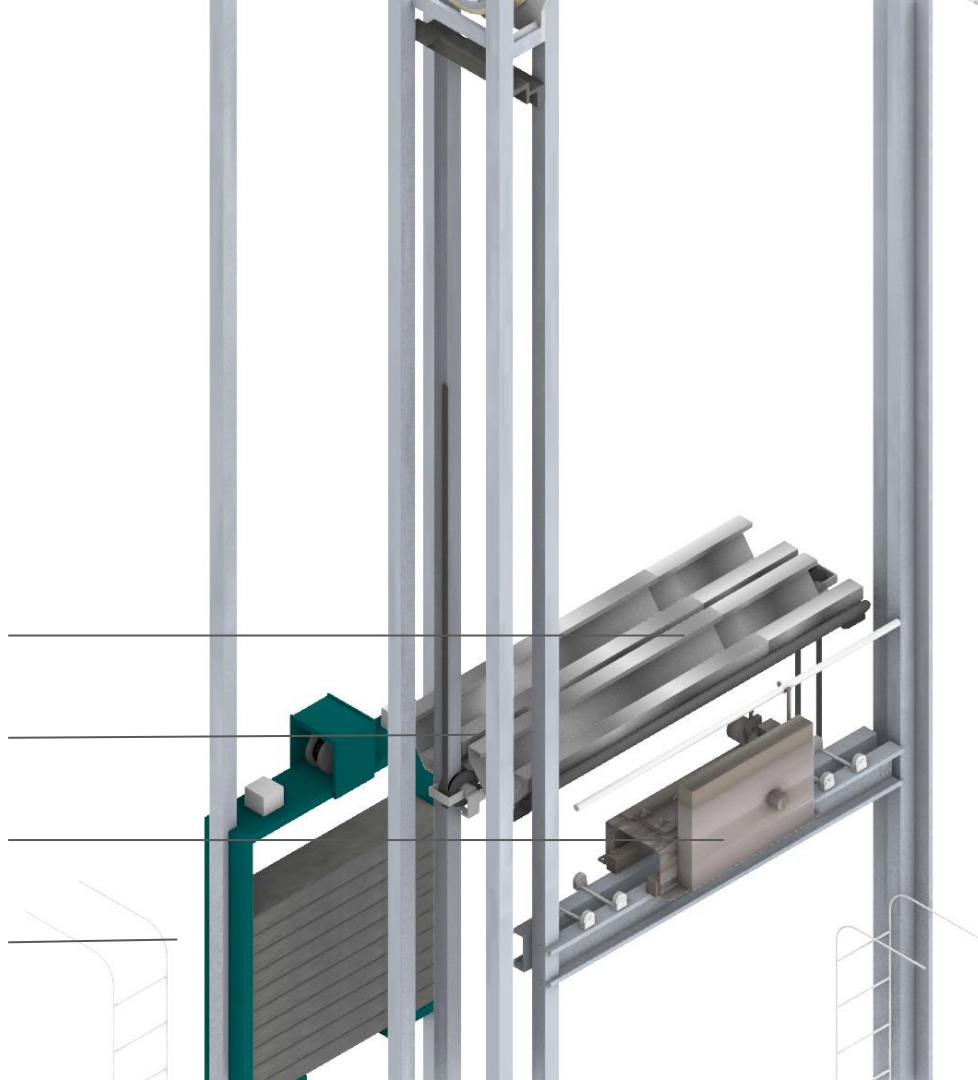

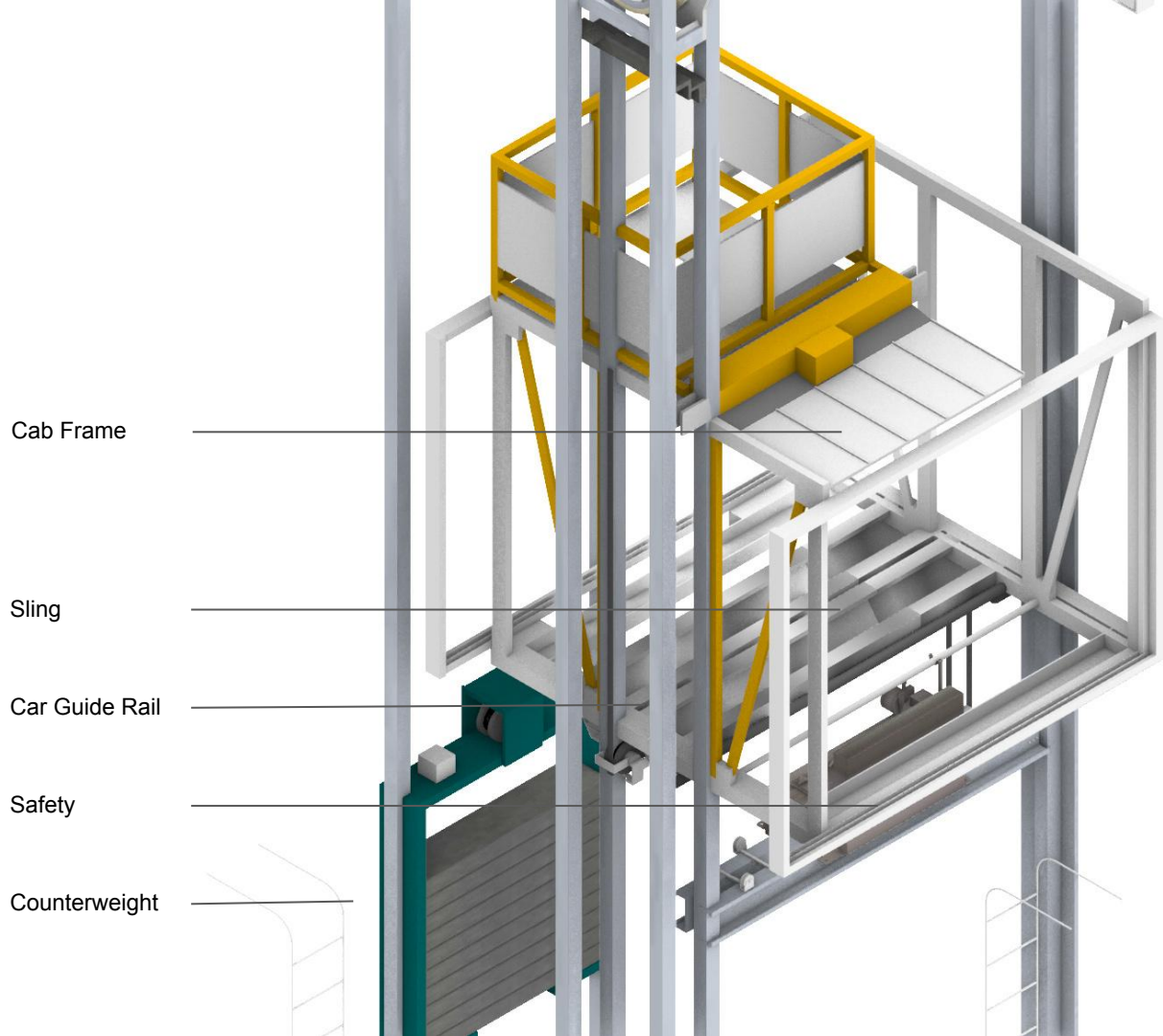

Cab Frame

Sling

Car Guide Rail

Safety

Counterweight

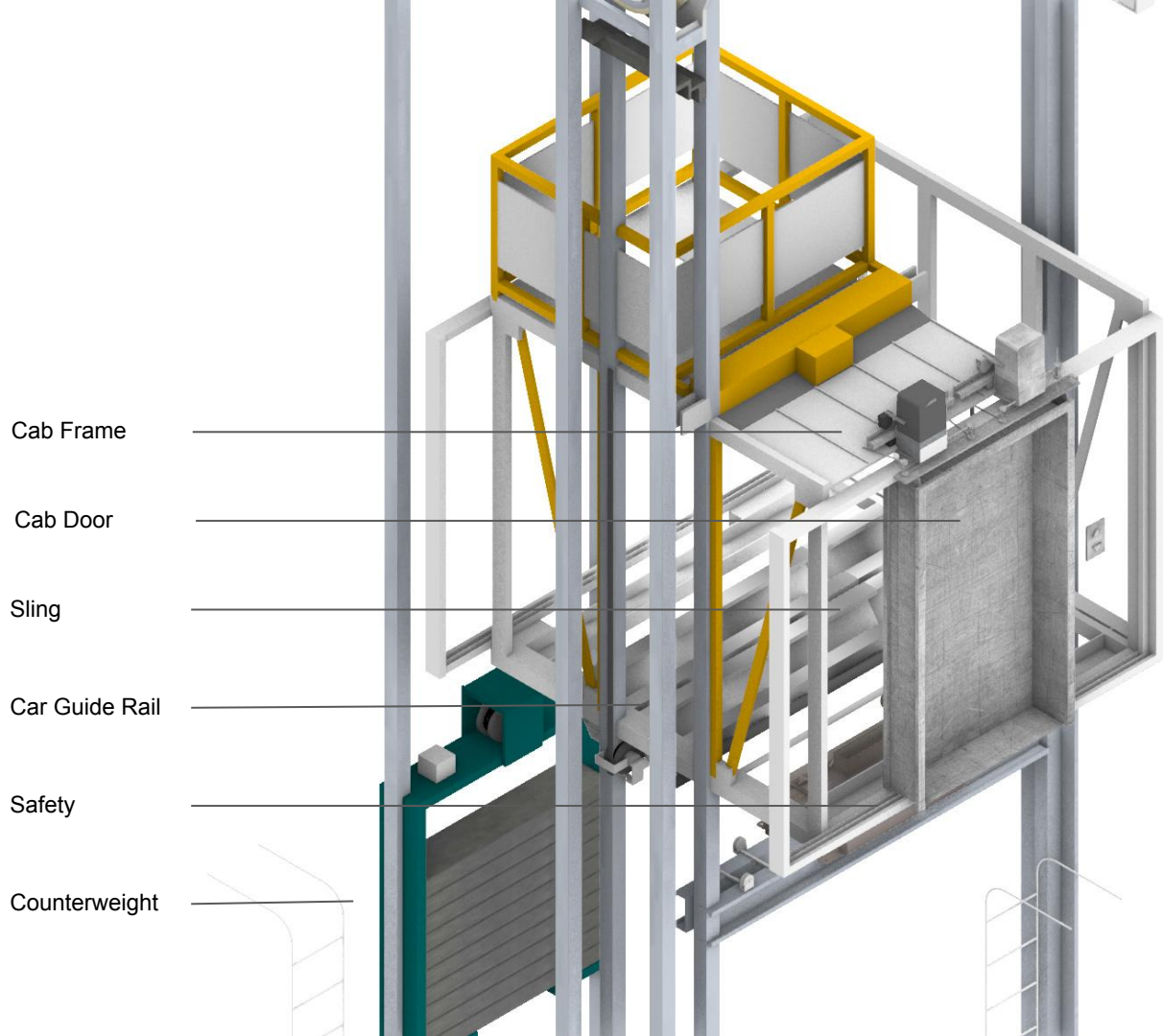

Cab Frame

Cab Door

Sling

Car Guide Rail

Safety

Counterweight

Cab Door Operator

Cab Frame

Cab Door

Car Guide Rail

Sling

Safety

Counterweight

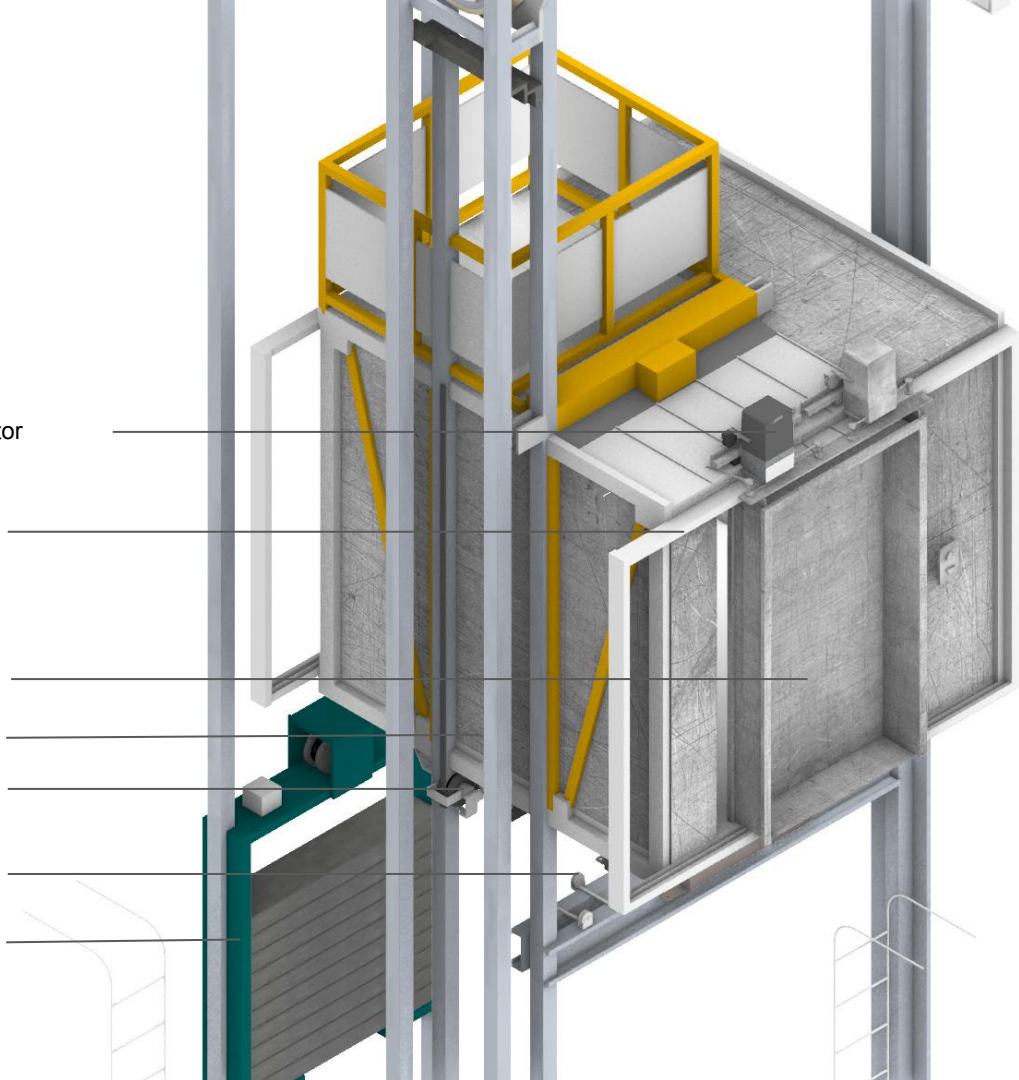

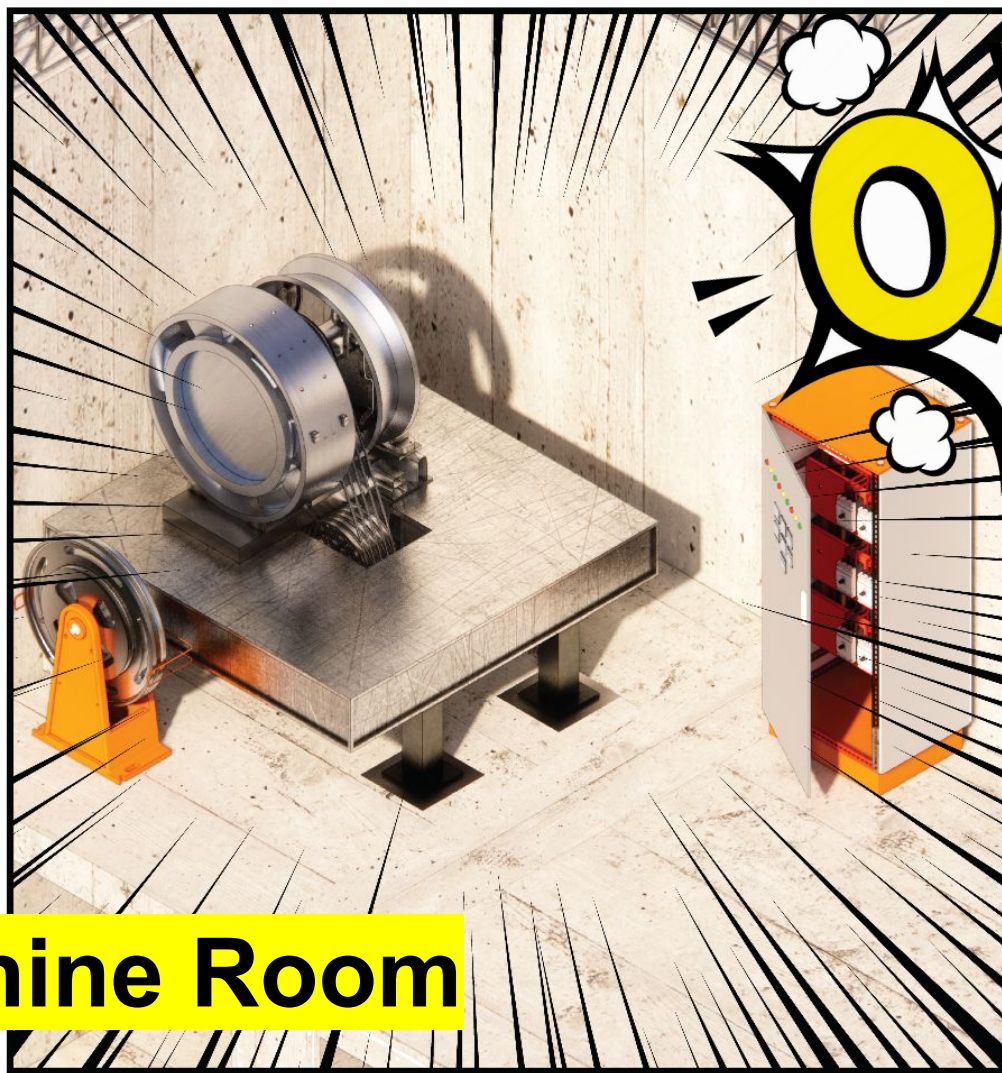

Top Machine Room

or
Roller
de

Elevator Machine Room

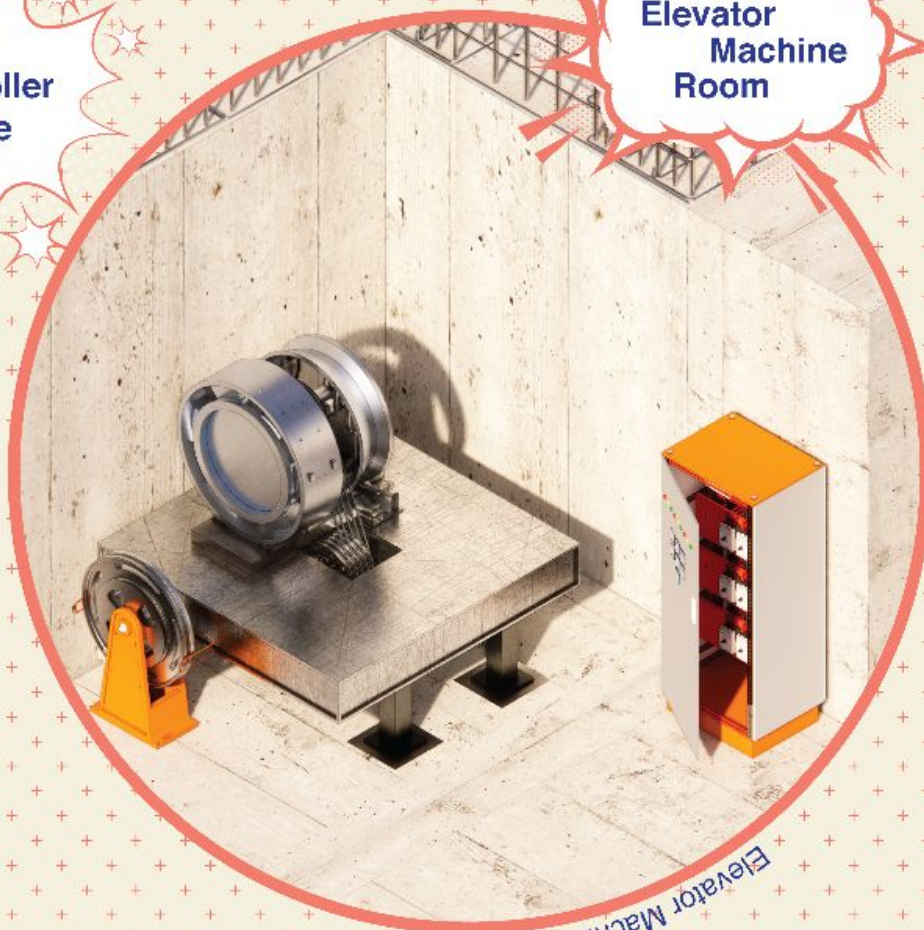

Elevator Machine Room

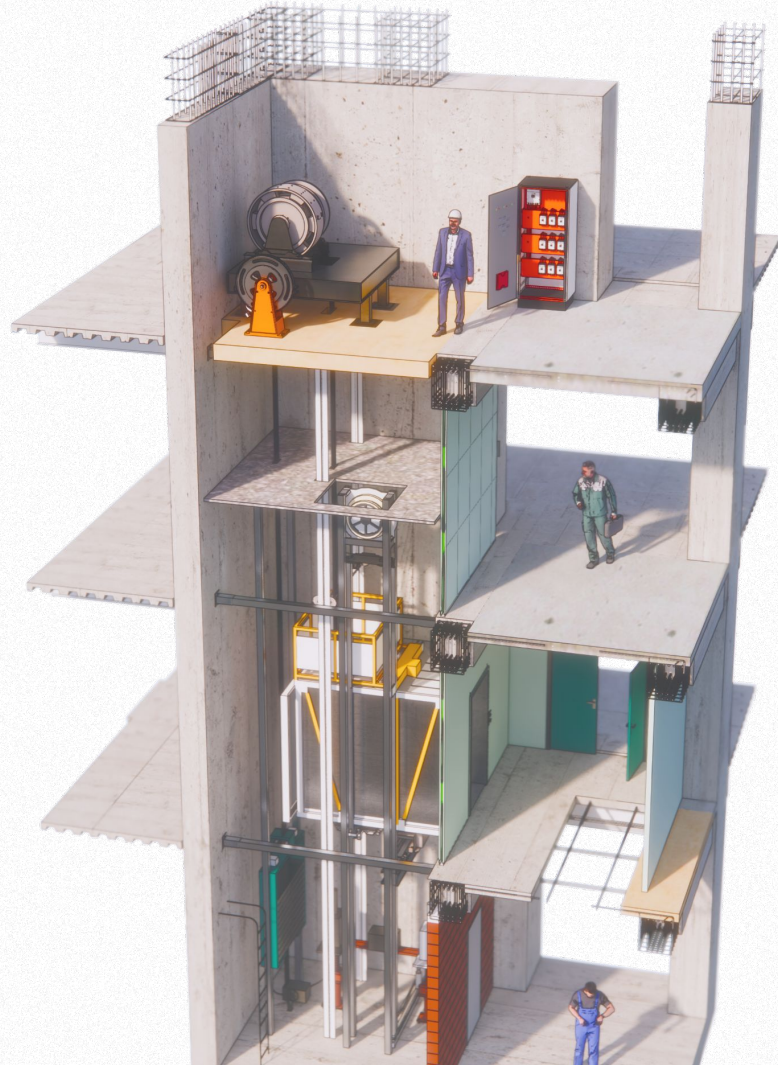

Rebars

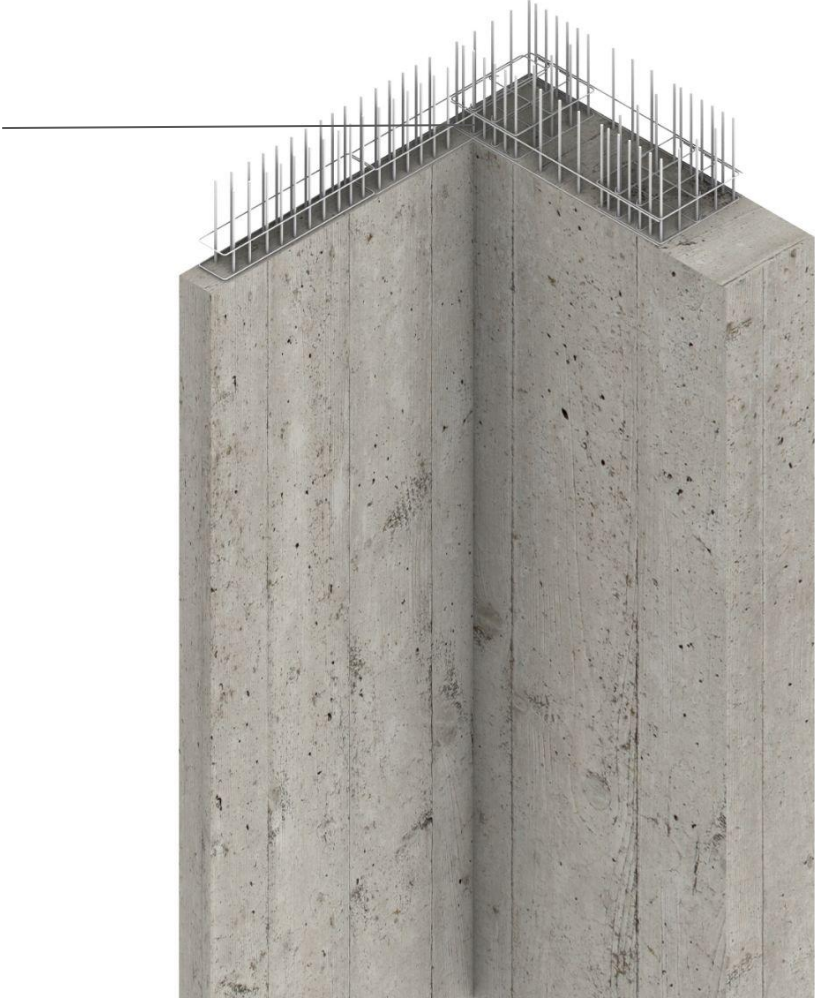

Rebars

I-Beams

Horizontal
Reinforcements

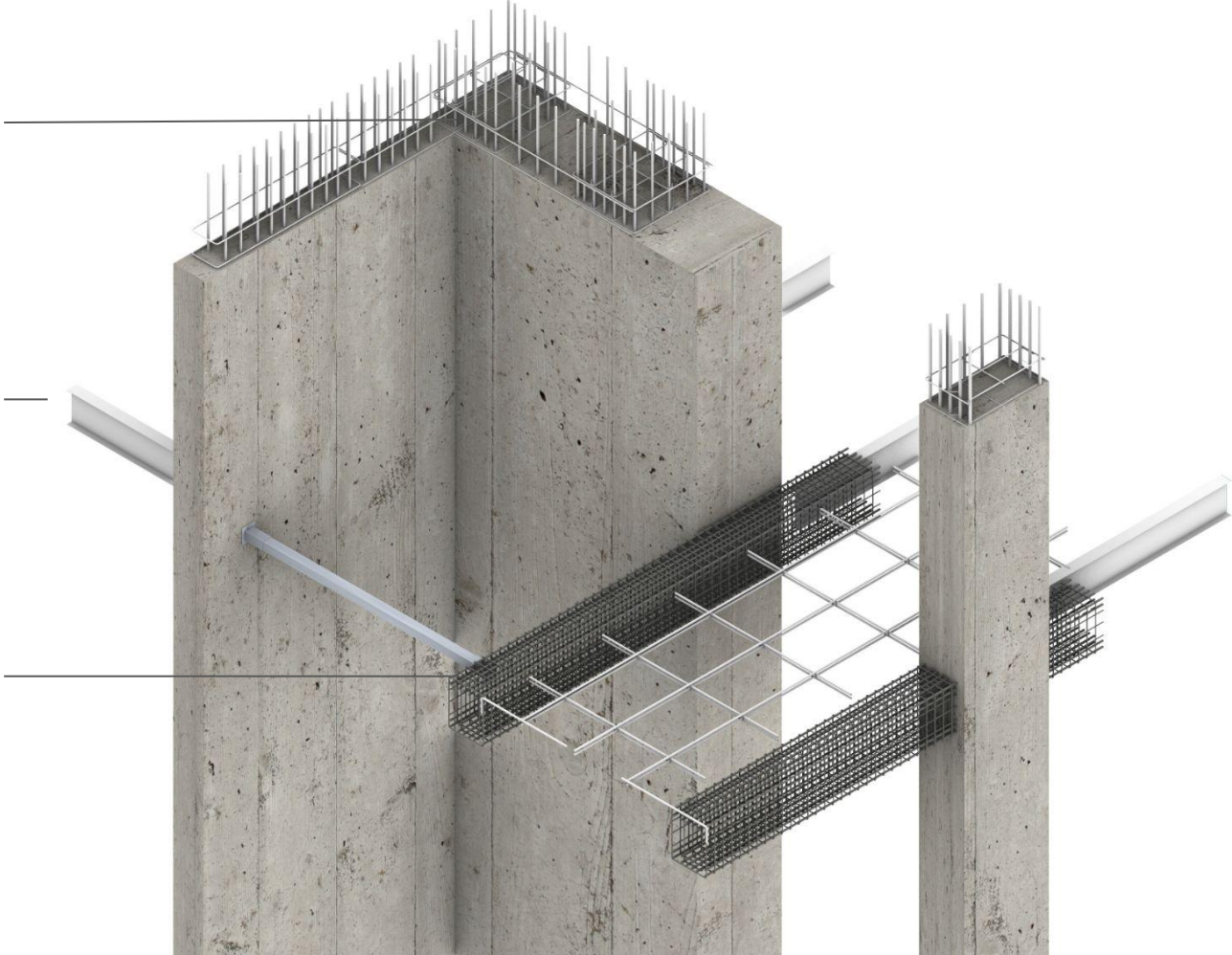

Rebars

Cast-in-Place
Concrete

I-Beams

Machine Base

Horizontal
Reinforcements

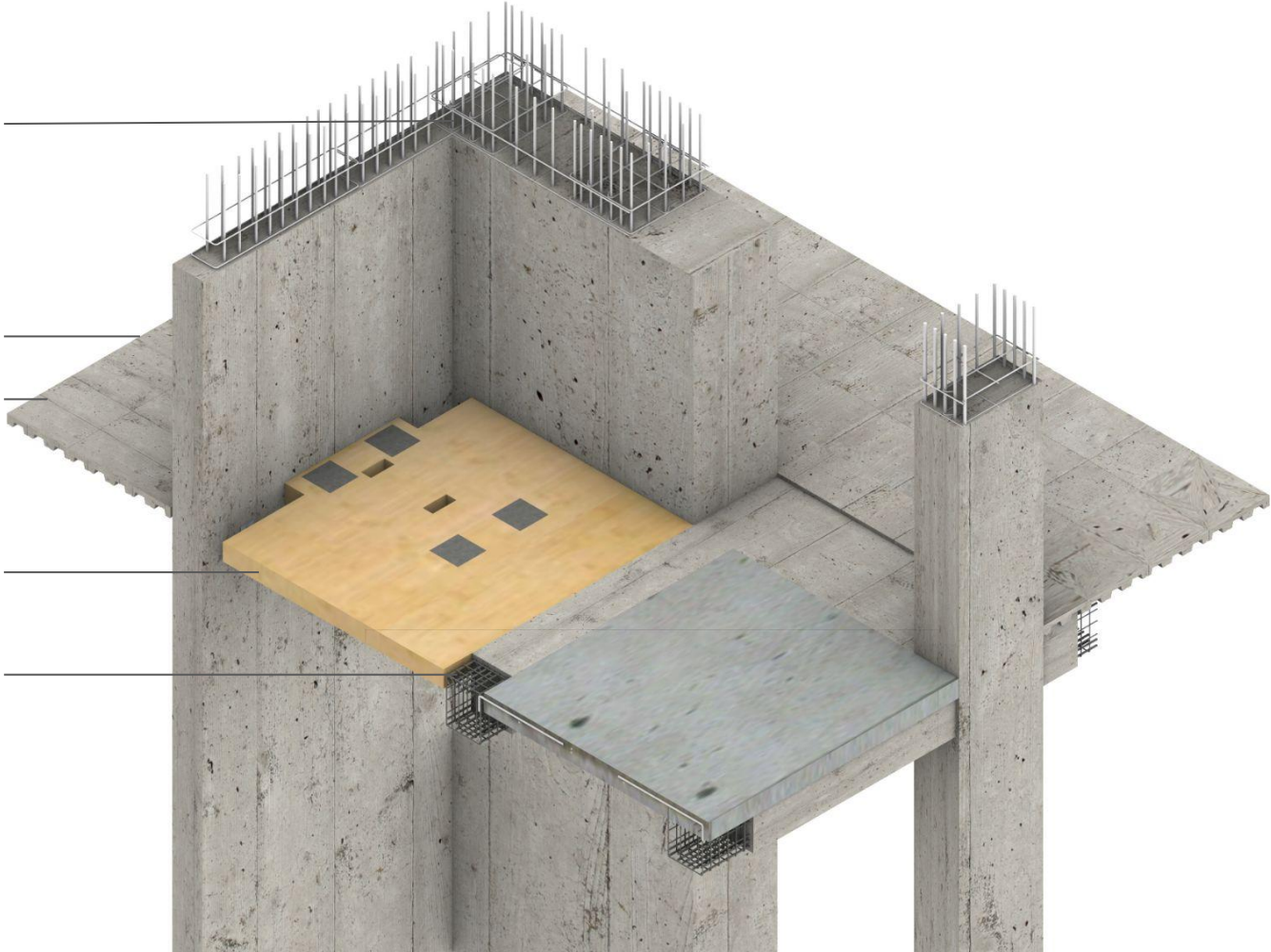

Rebars

Cast-in-Place
Concrete

I-Beams

Machine Base

Horizontal
Reinforcements

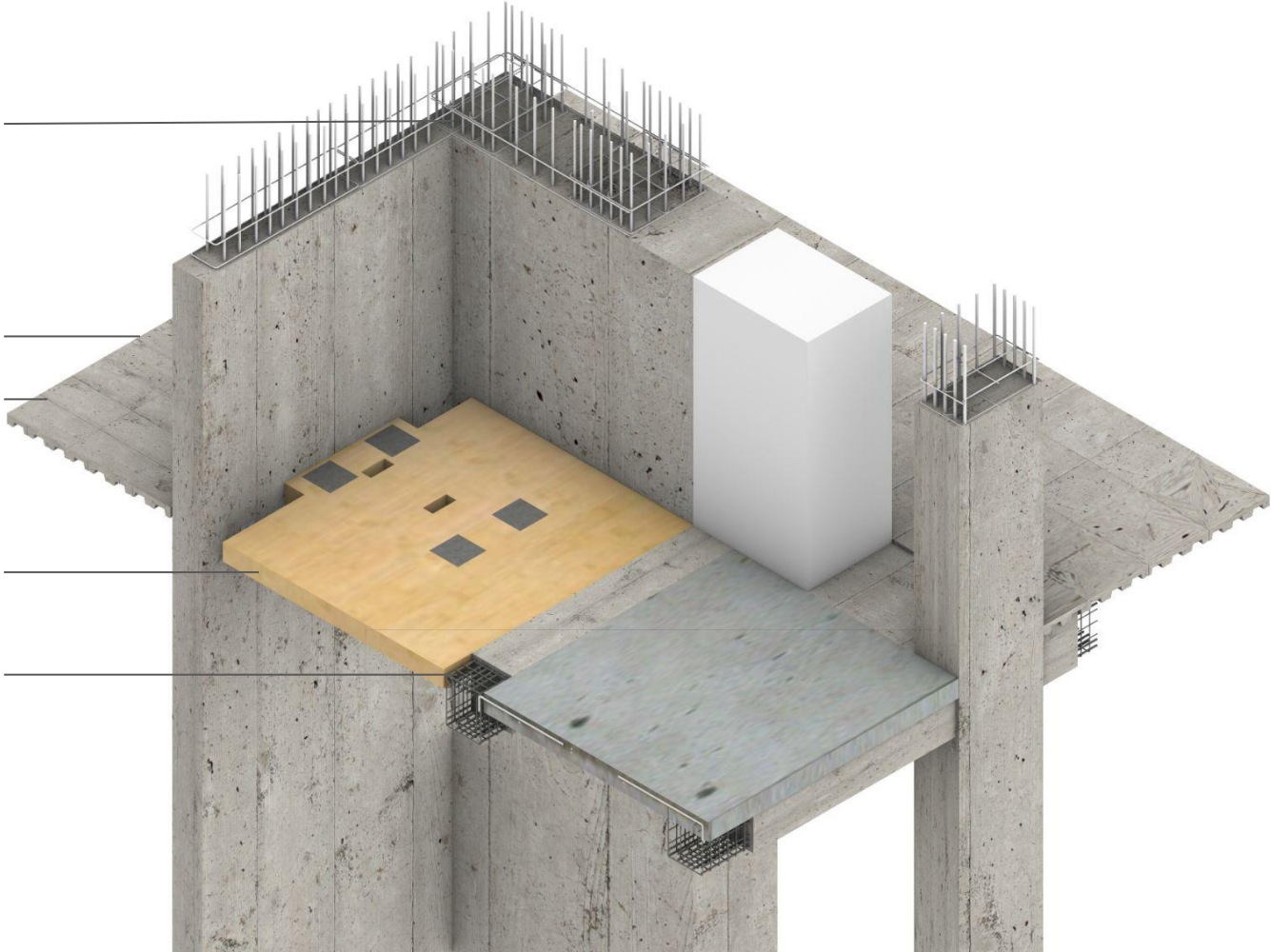

Rebars

Cast-in-Place
Concrete

I-Beams
Machine

Platform

Machine Base
Controller

Horizontal
Reinforcements

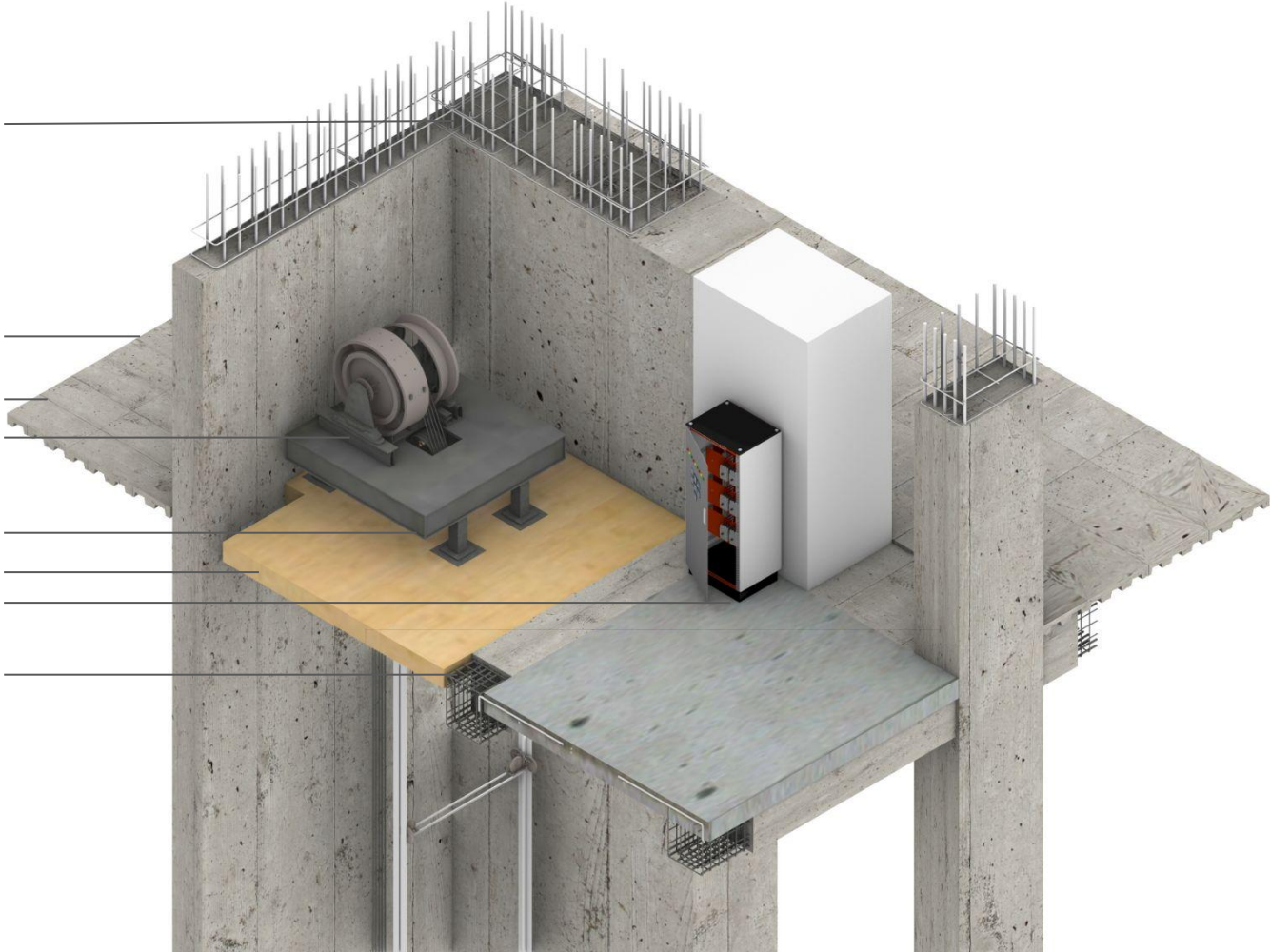

Rebars

Cast-in-Place
Concrete

I-Beams

Machine

Brakes

Platform

Machine Base
Controller

Horizontal
Reinforcements

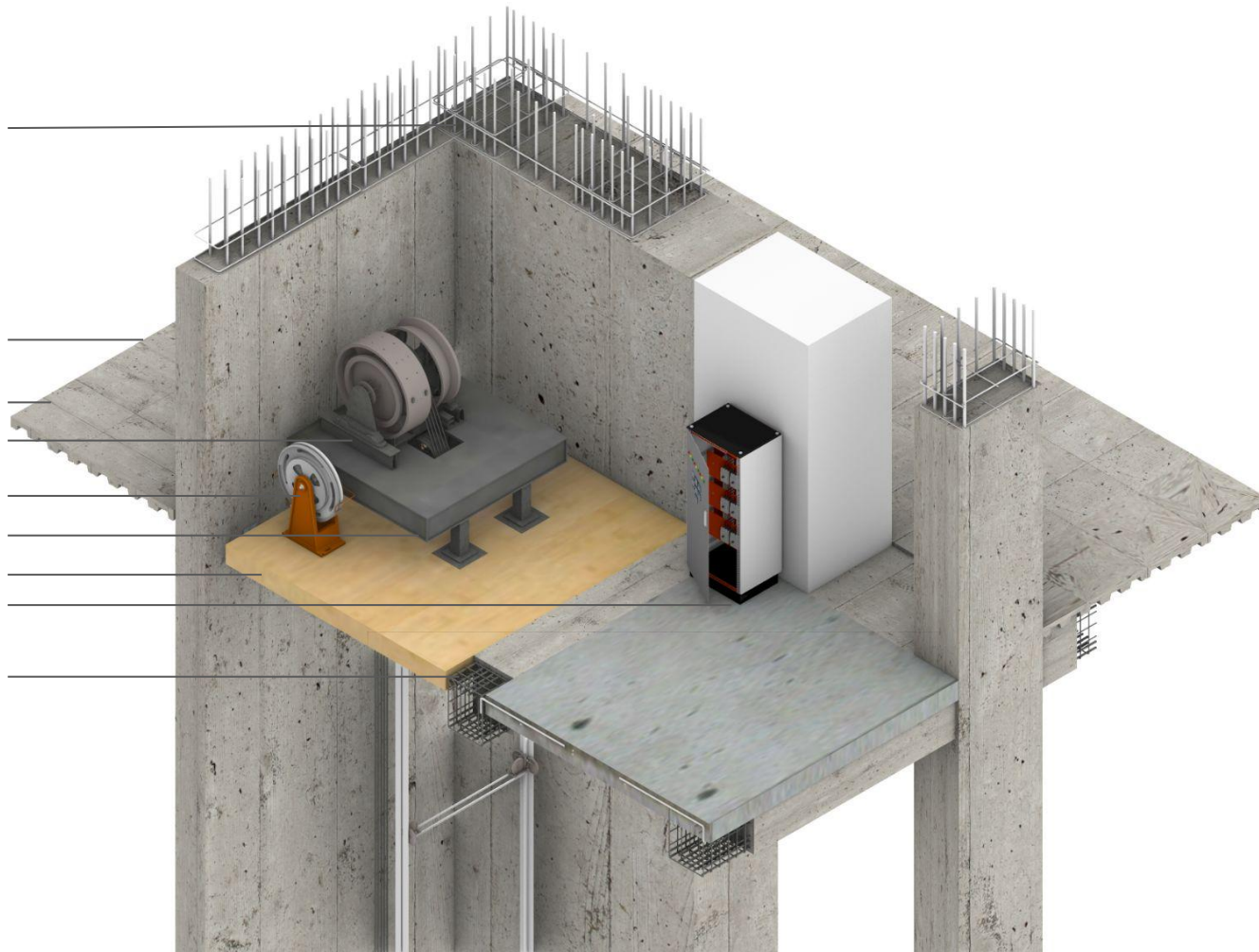

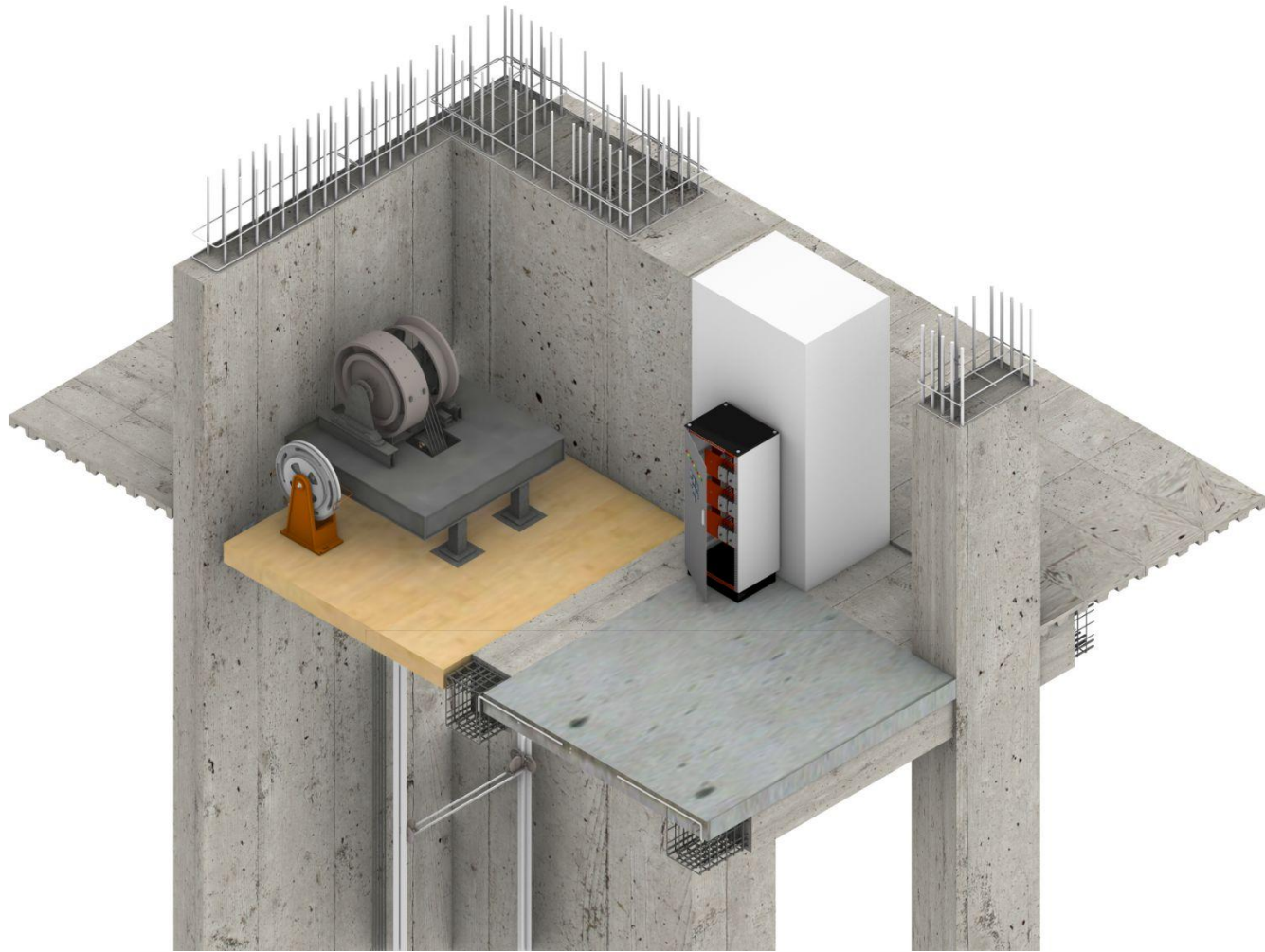

Final Drawing

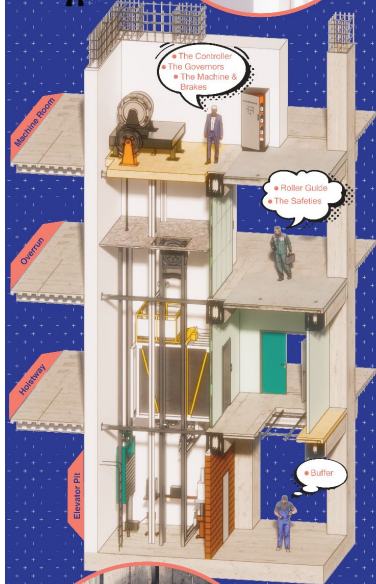
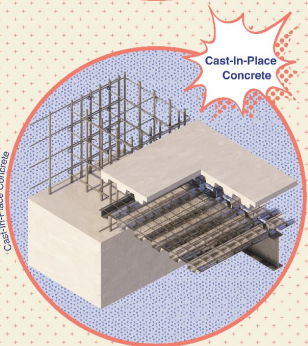
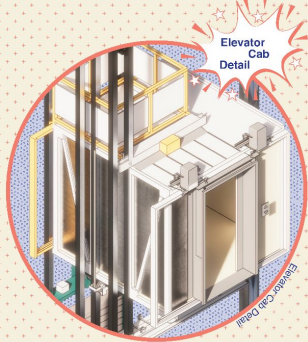
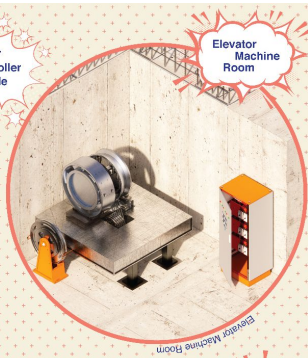

Shiming Hong Saung Ho Shin Yifei Yuan Kent Kosakind

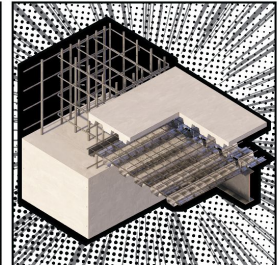
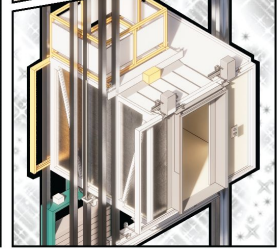
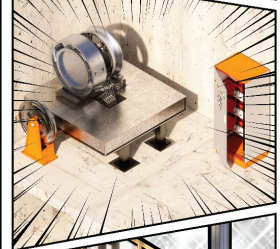
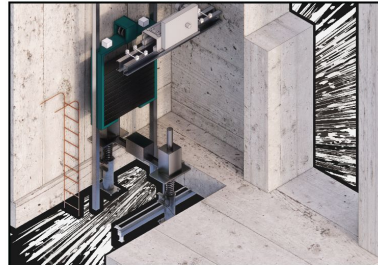

Process Images

