

Location: New York, NY
Program: Art Foundation/Gallery

Art Inspiration:
Piet Mondrian
Composition 8 , 1914

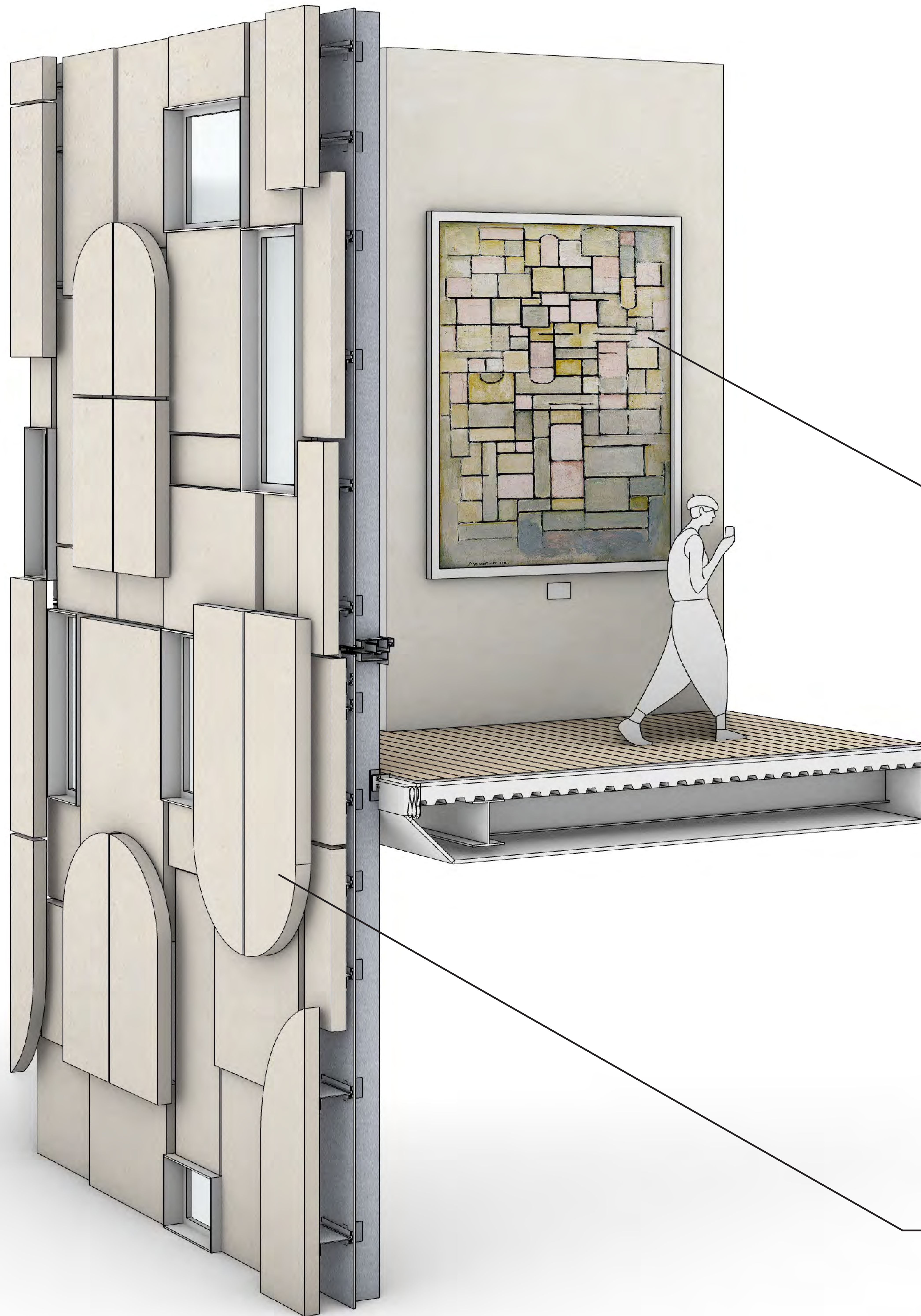

Material:
4" thick Jura Limestone



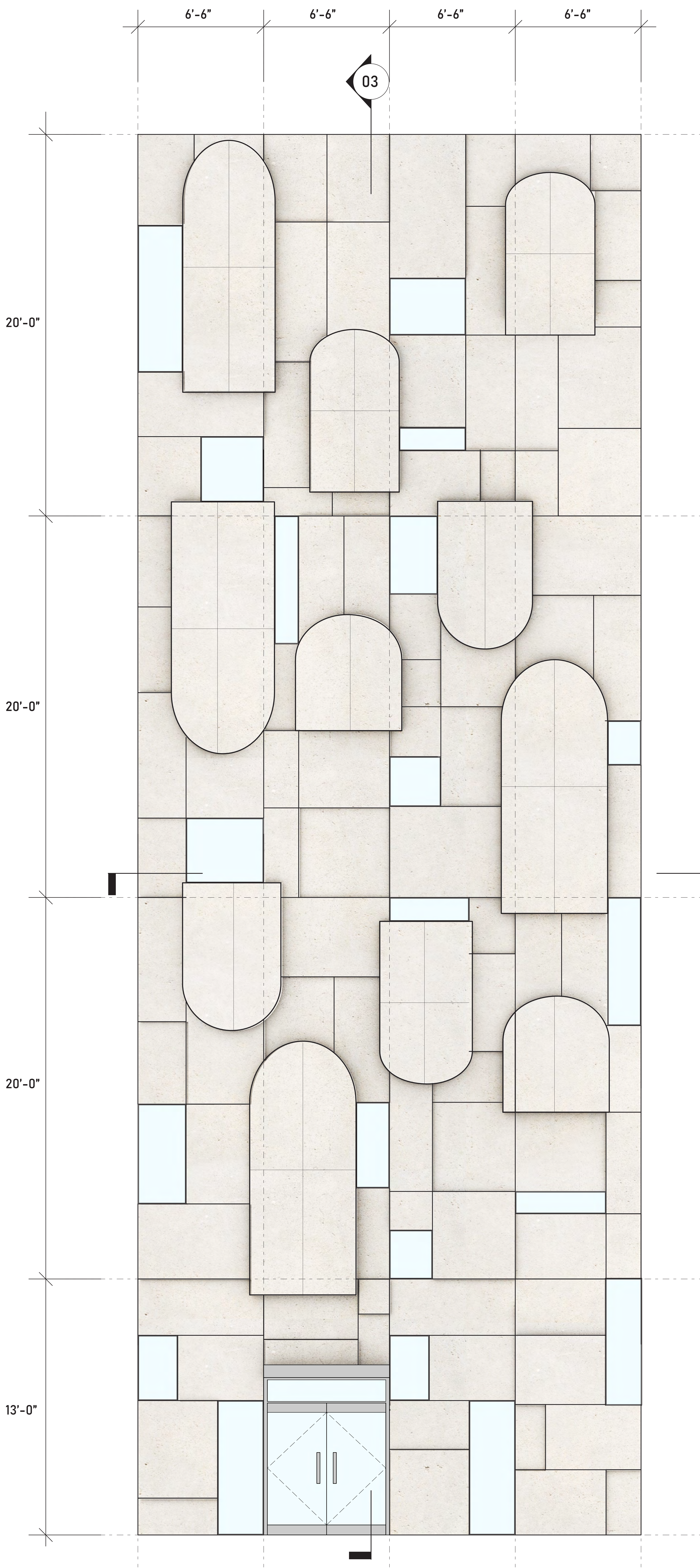

01 Elevation - Full Facade
1/2" = 1'-0"

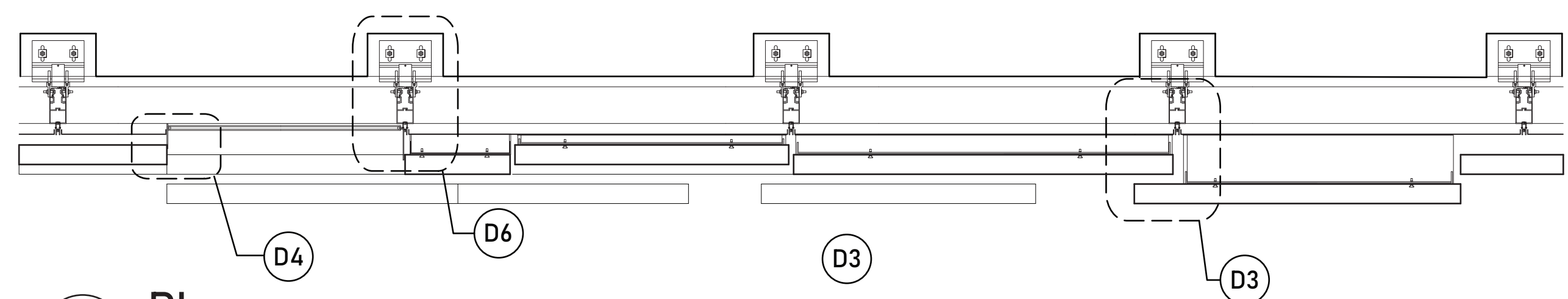

02 Plan
1/2" = 1'-0"

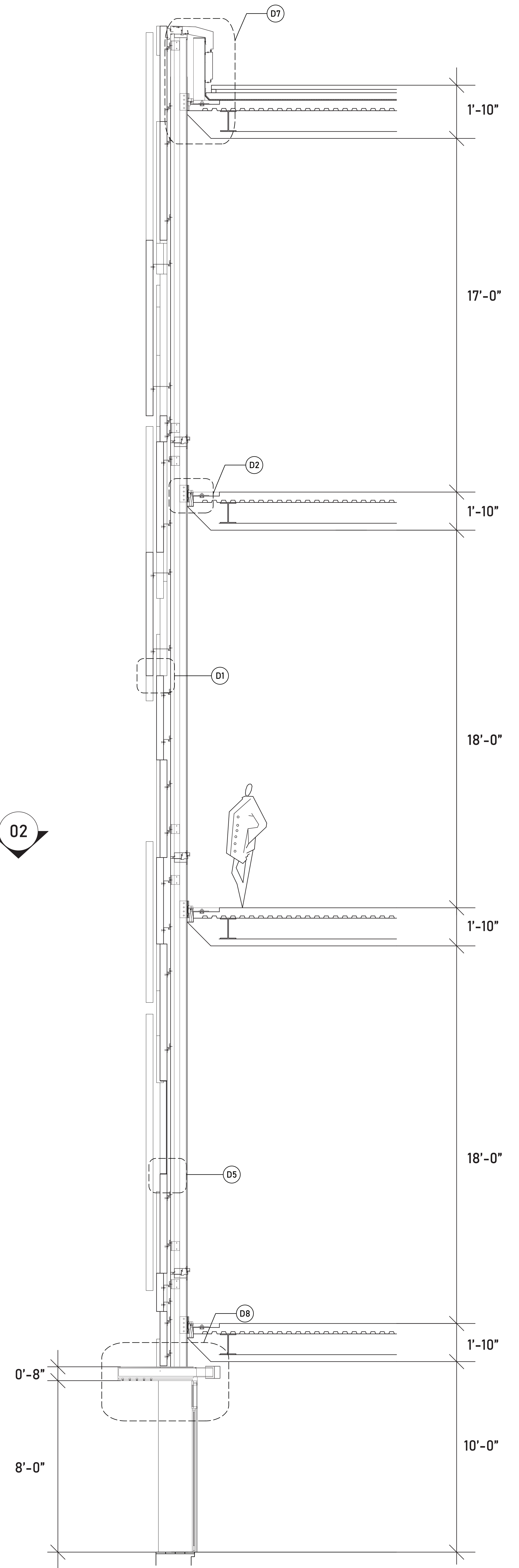

03 Section
1/2" = 1'-0"

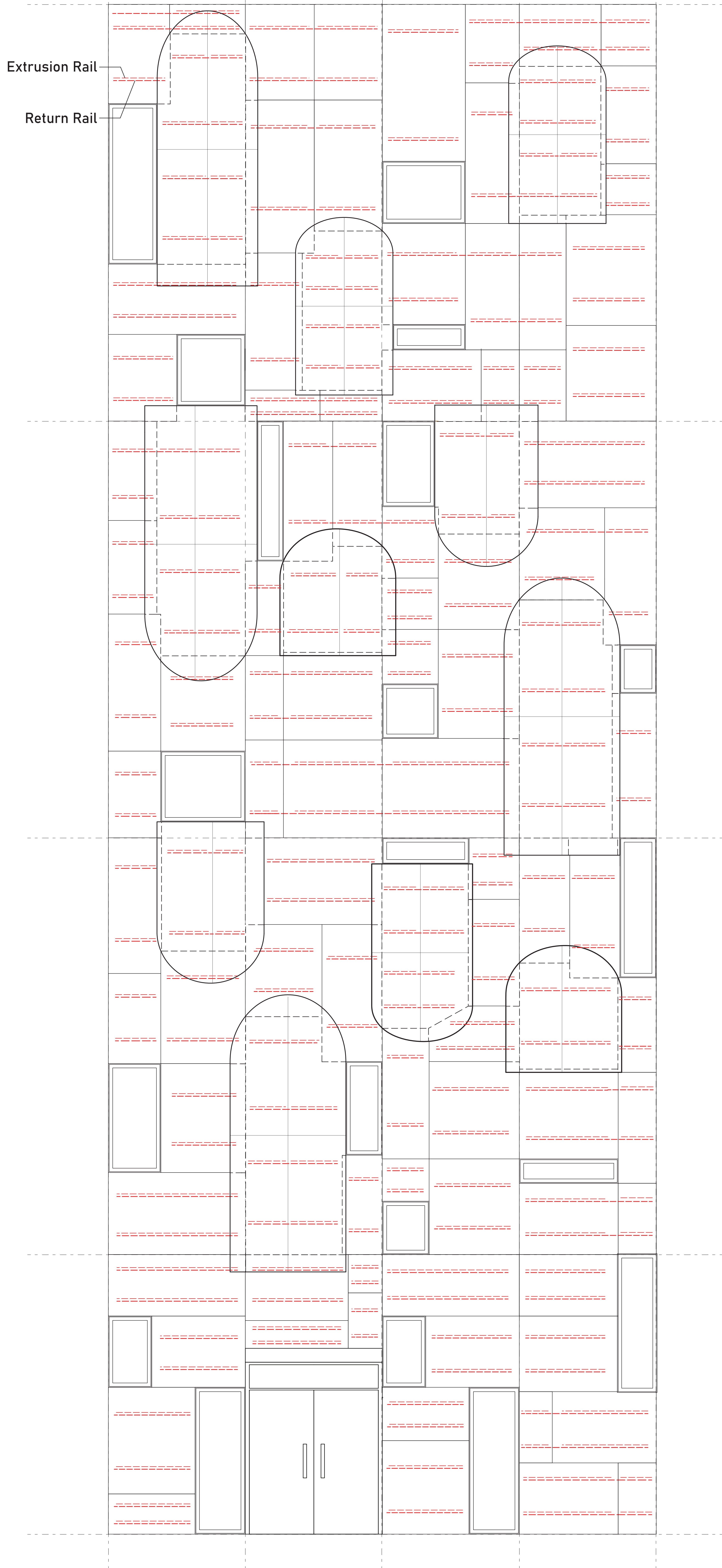

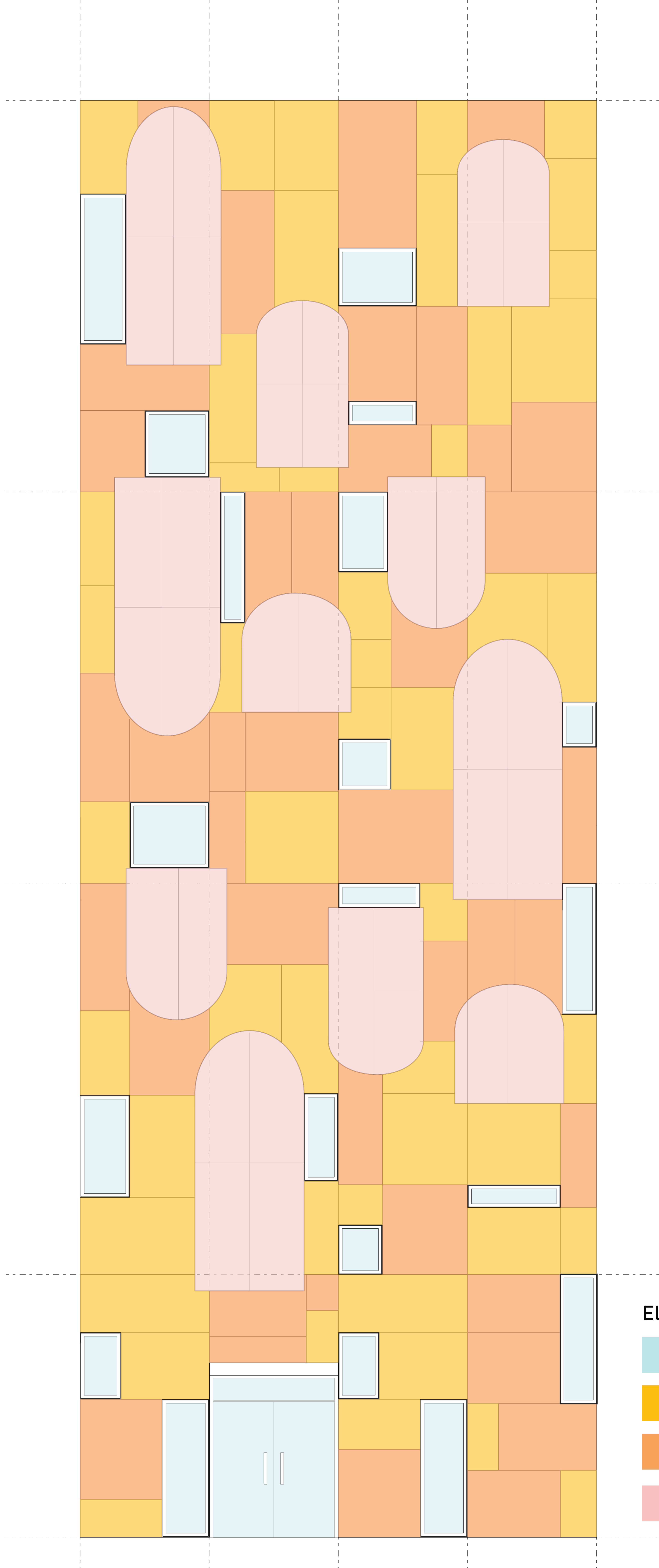

05 Elevation Diagram
1/2" = 1'-0"

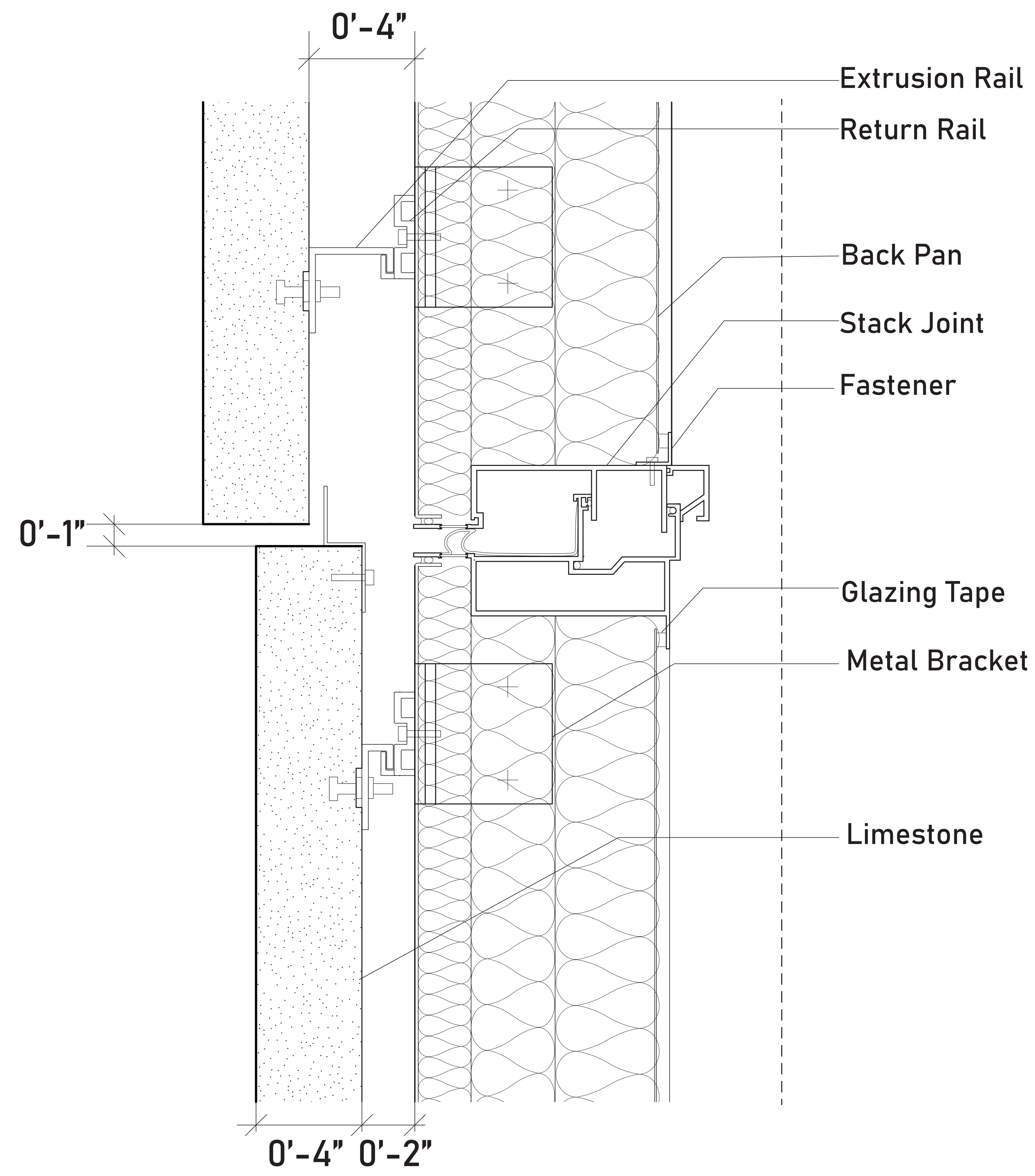

D1 Section - Limestone to Mullion Connection
3" = 1'-0"

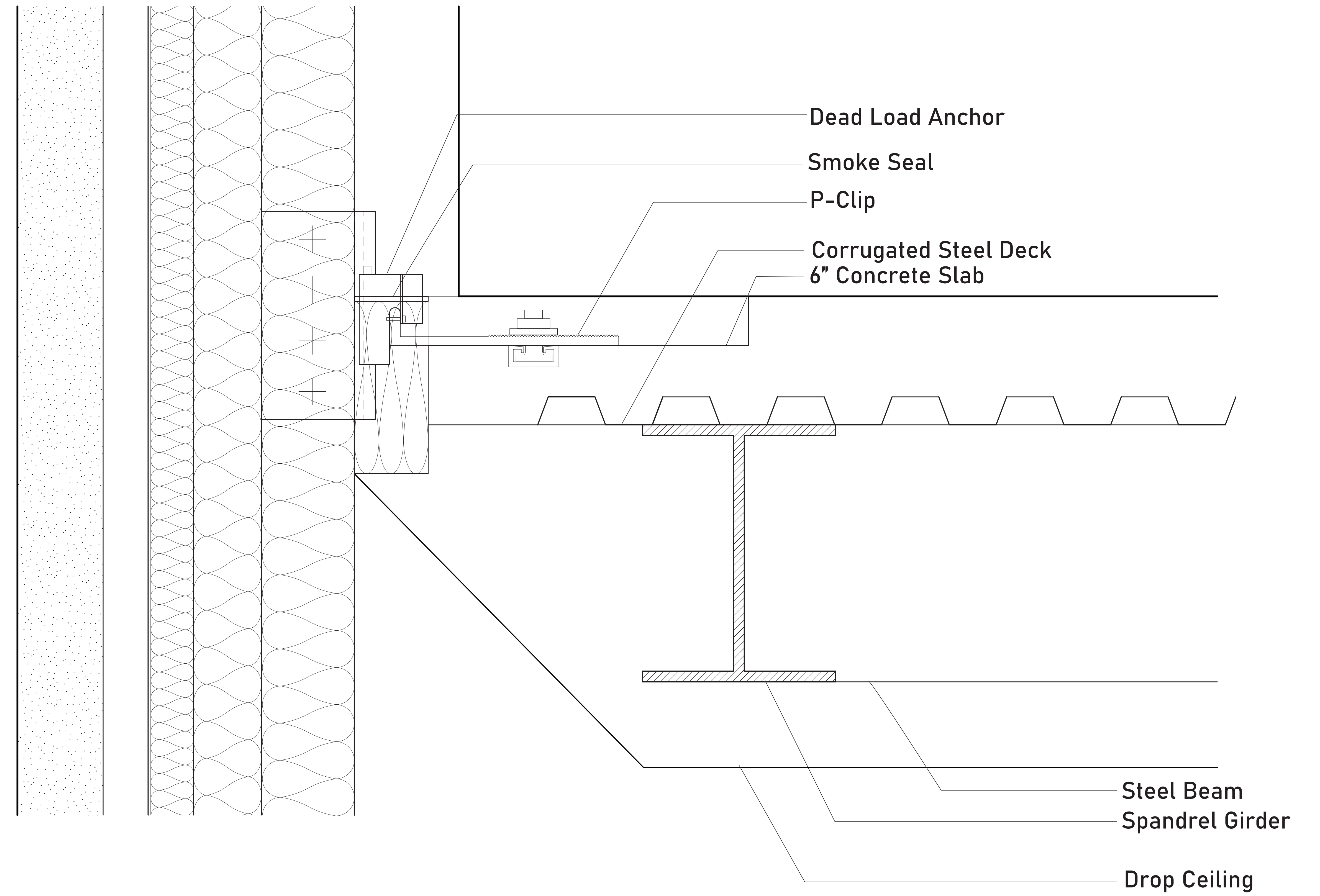

D2 Section - Mullion to Floor Connection
3" = 1'-0"

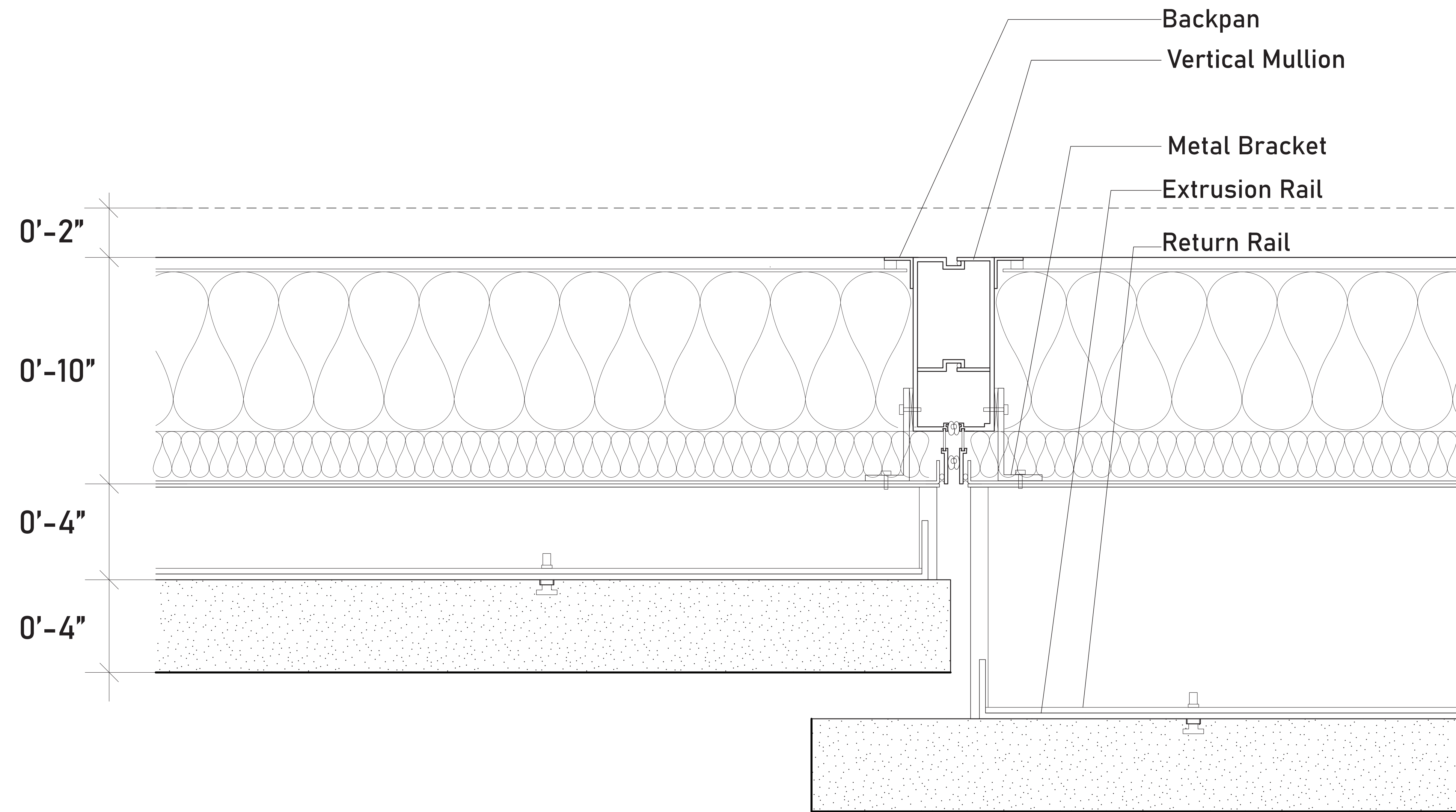

D3 Enlarged Plan - Limestone to Mullion
3" = 1'-0"

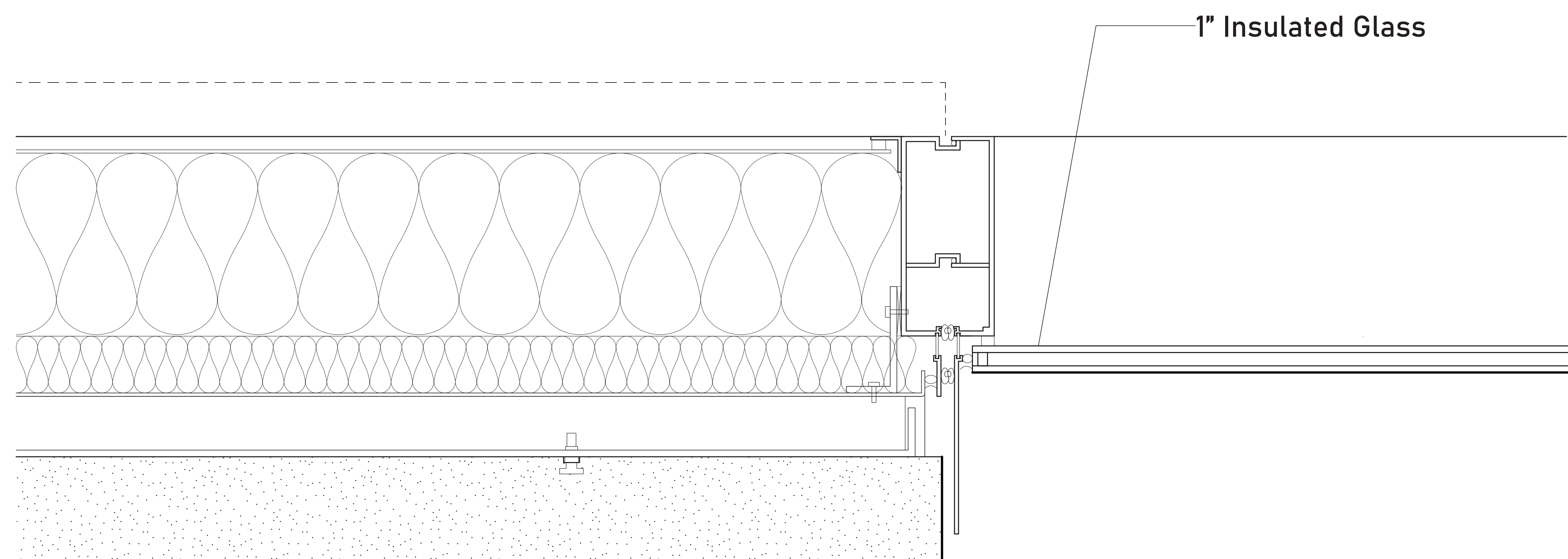

D4 Enlarged Plan - Limestone to Glass Connection
3" = 1'-0"

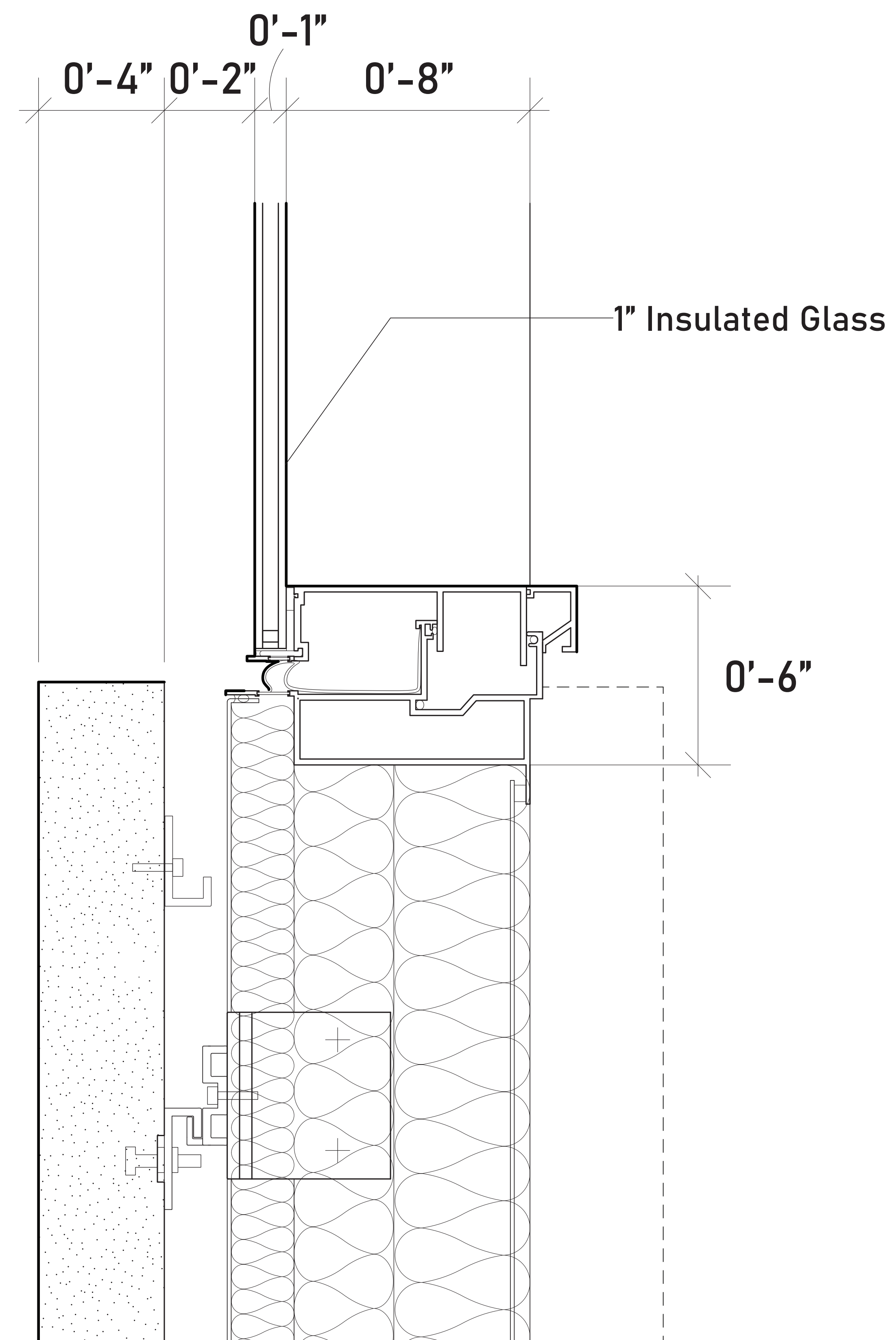

D5 Section - Limestone to Glass Connection
 3" = 1'-0"

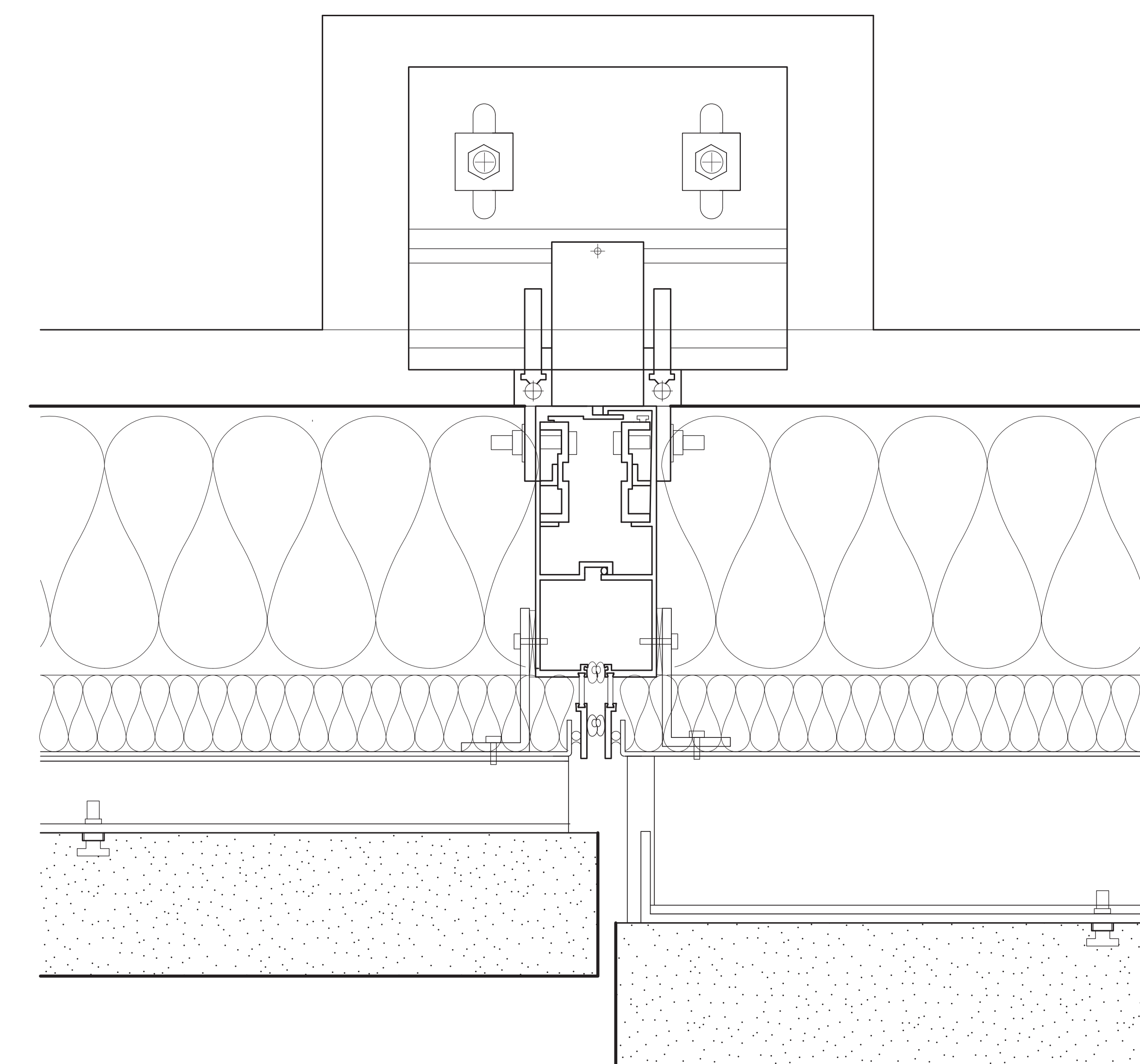

D6 Enlarged Plan - Mullion to Slab Connection
 3" = 1'-0"

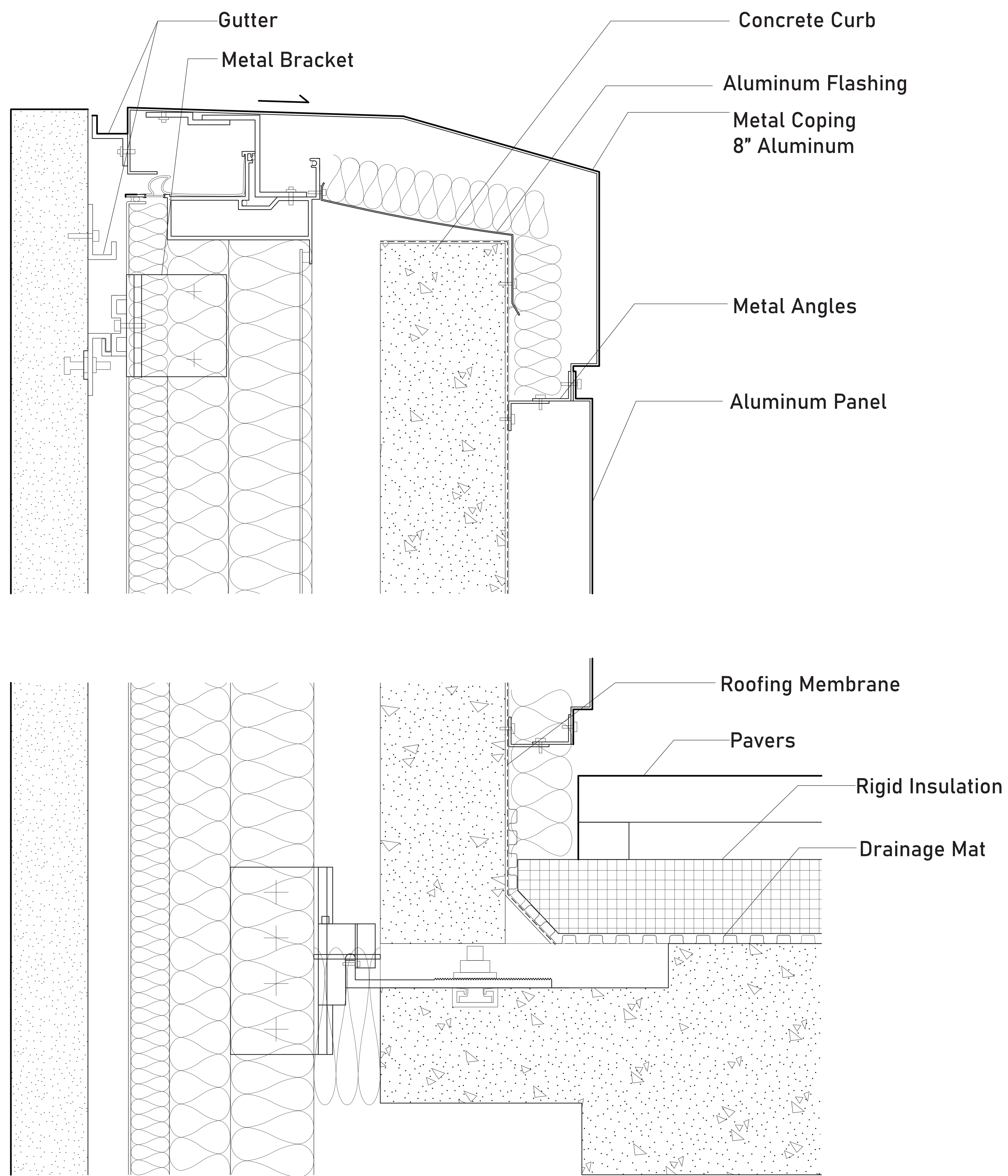

D7 Section - Parapet
3" = 1'-0"

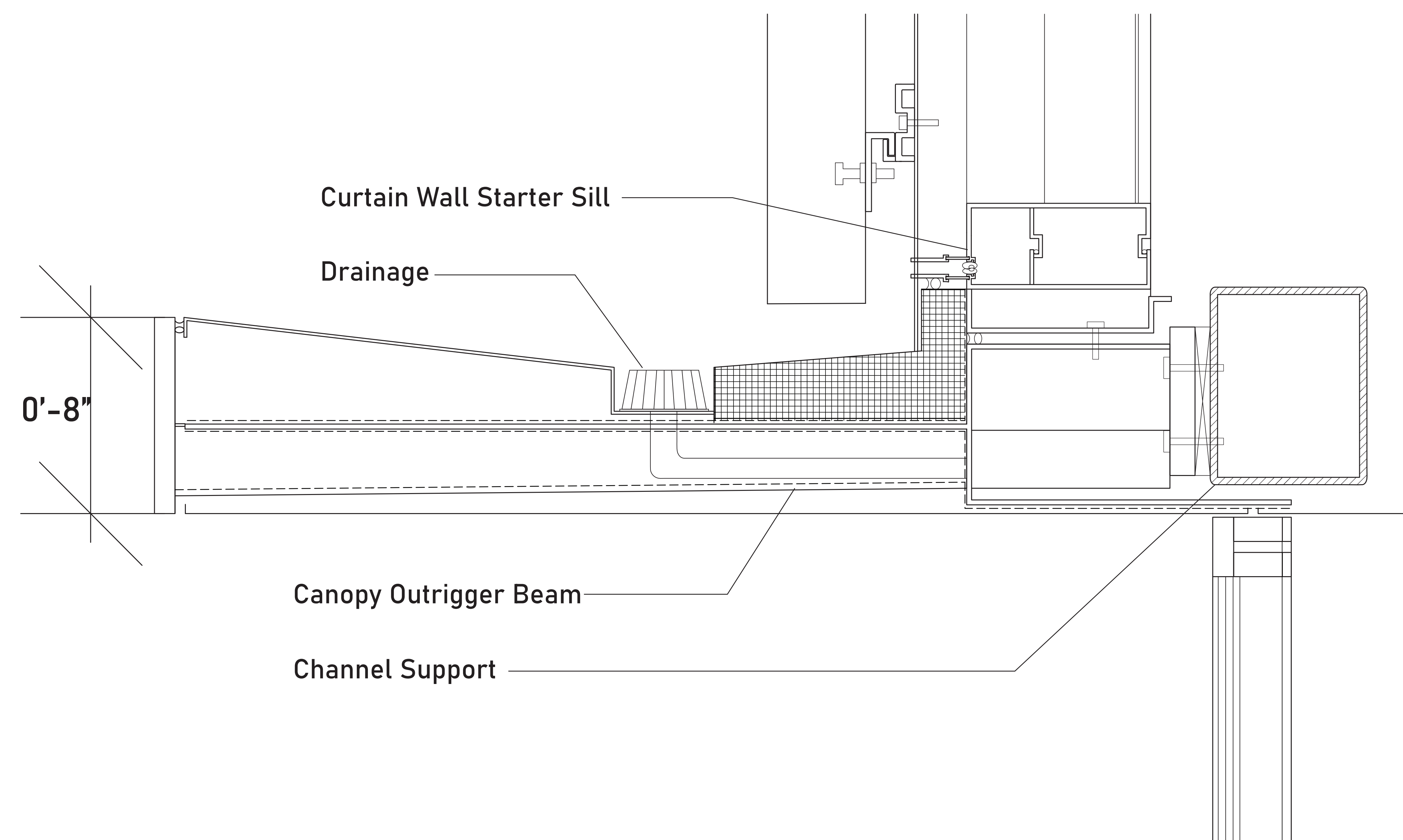

D8 Section - Canopy Above Entry Door
2" = 1'-0"