

SCHOOL WITH A VIEW
THE XR SCHOOL

CARA DePIPP0

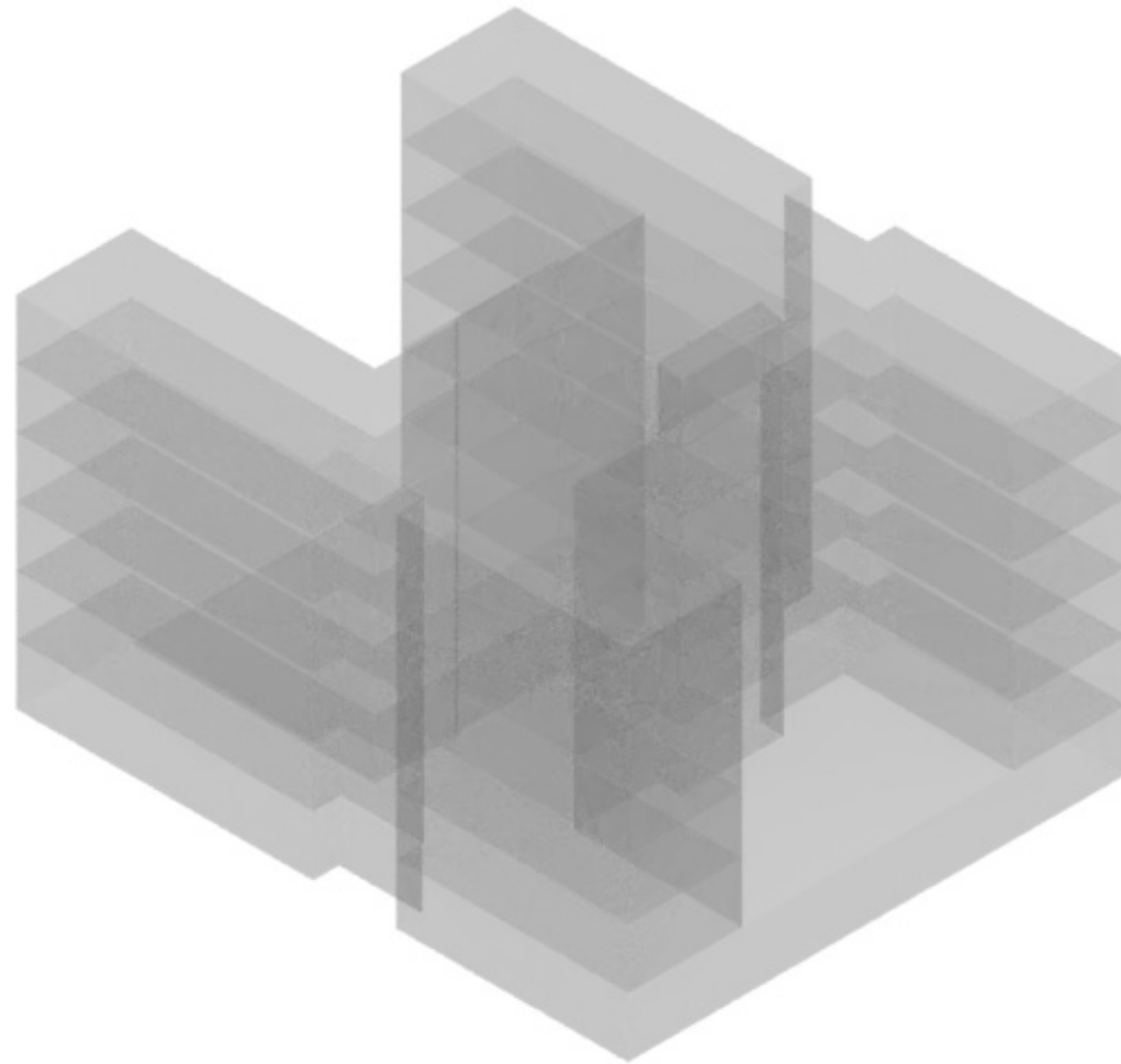

ORIGINAL MASSING

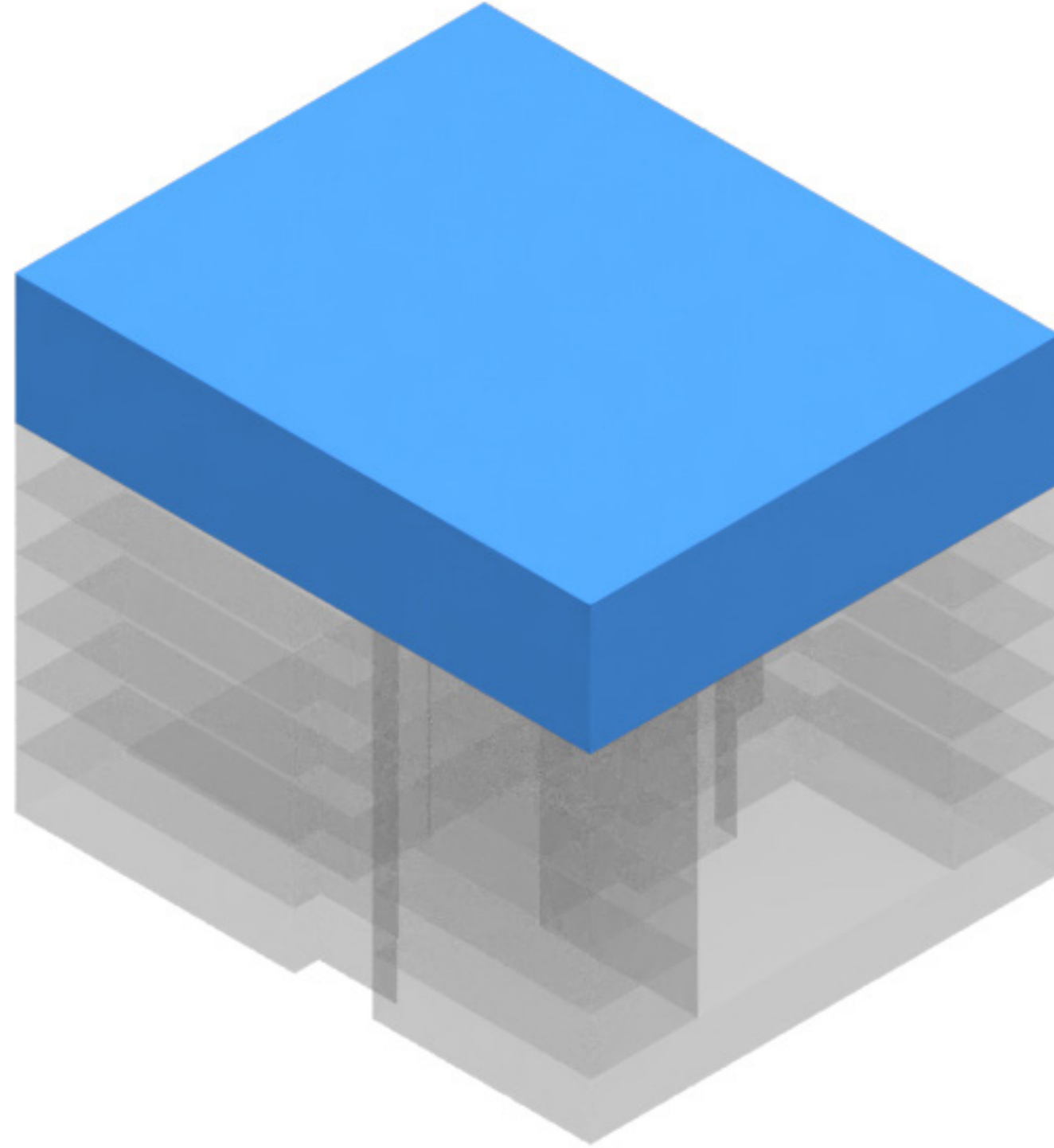

ROOF ADDITION

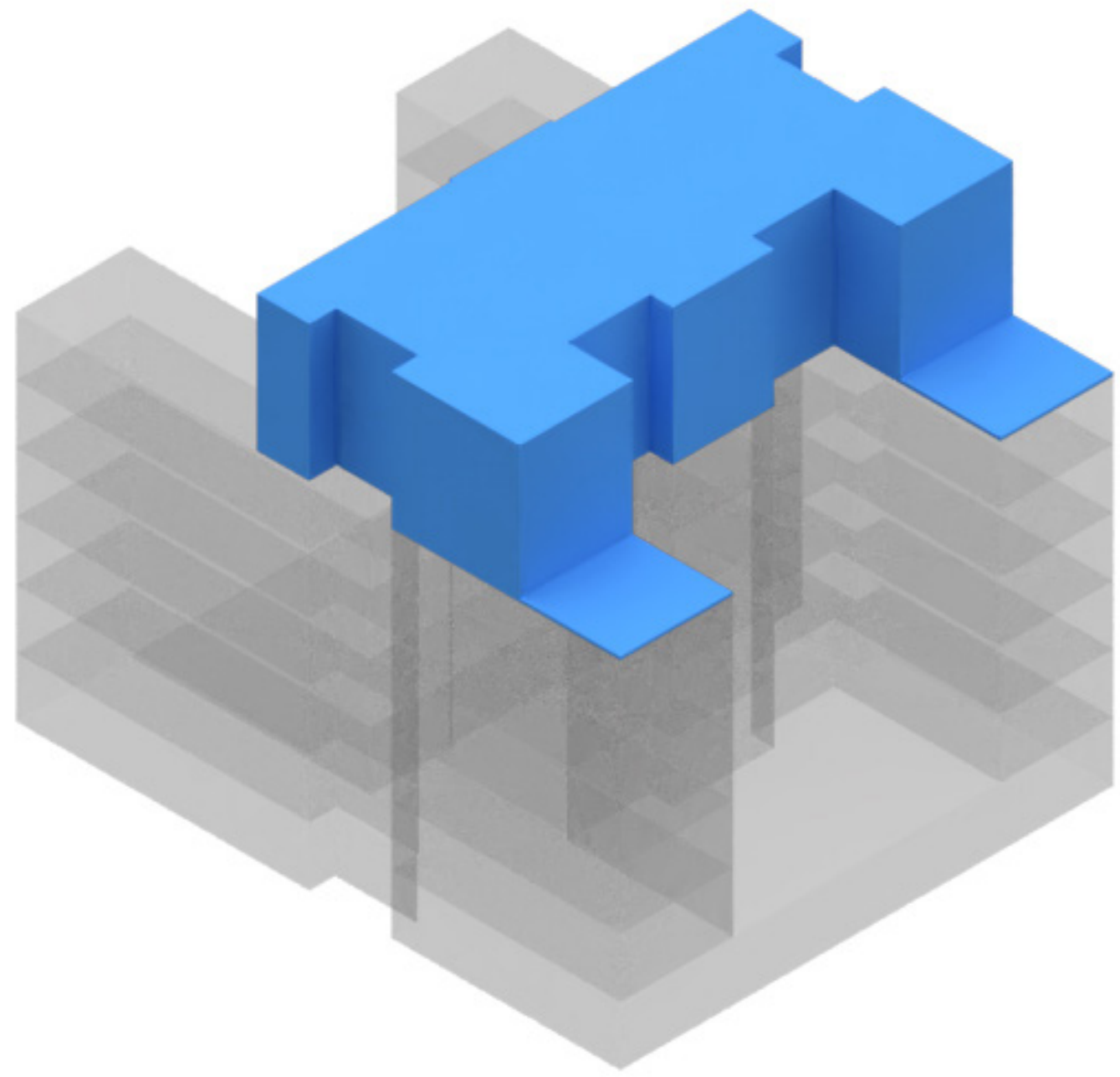

REFINED ROOF ADDITION

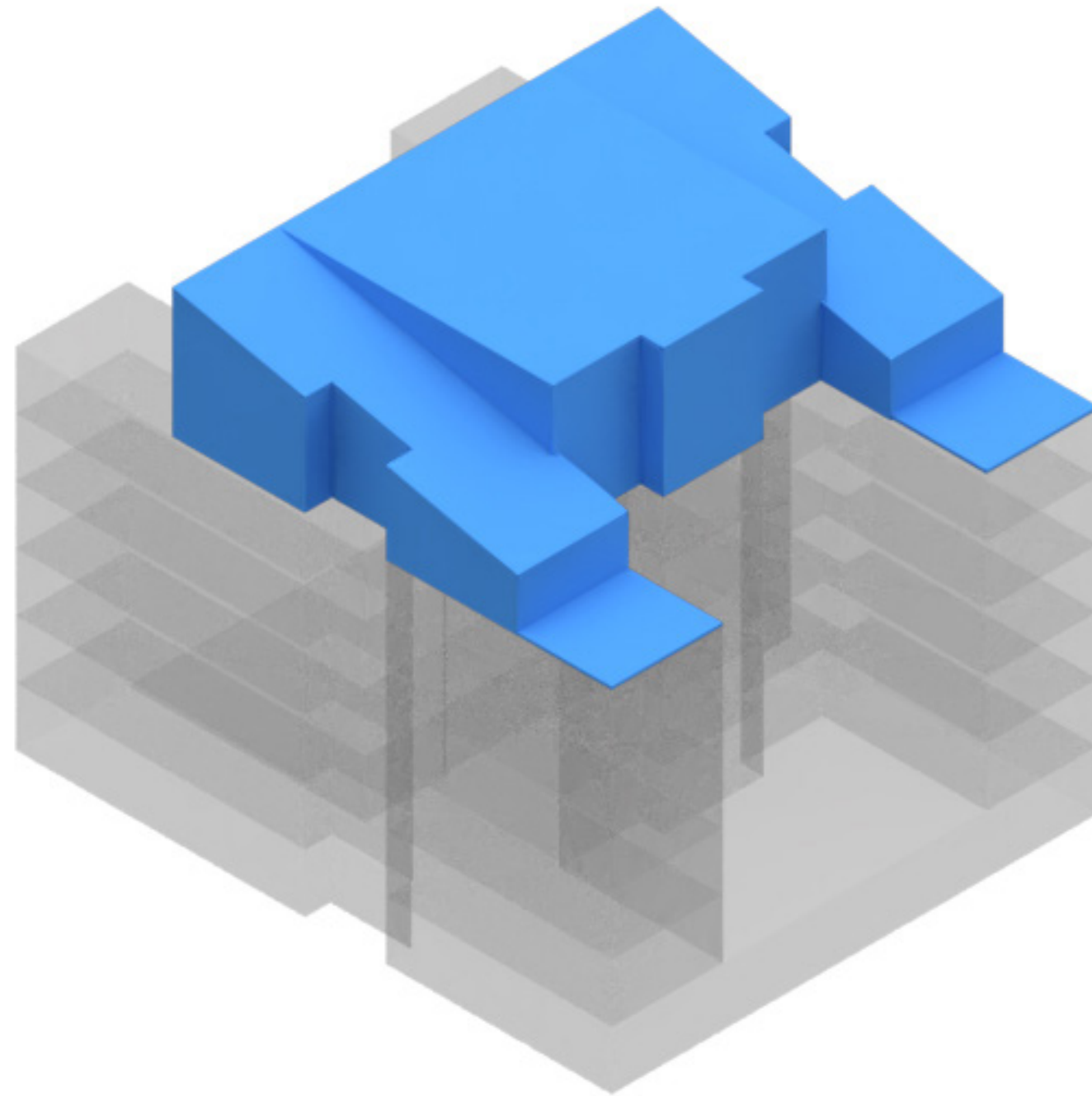

ROOF ADDITION FORM

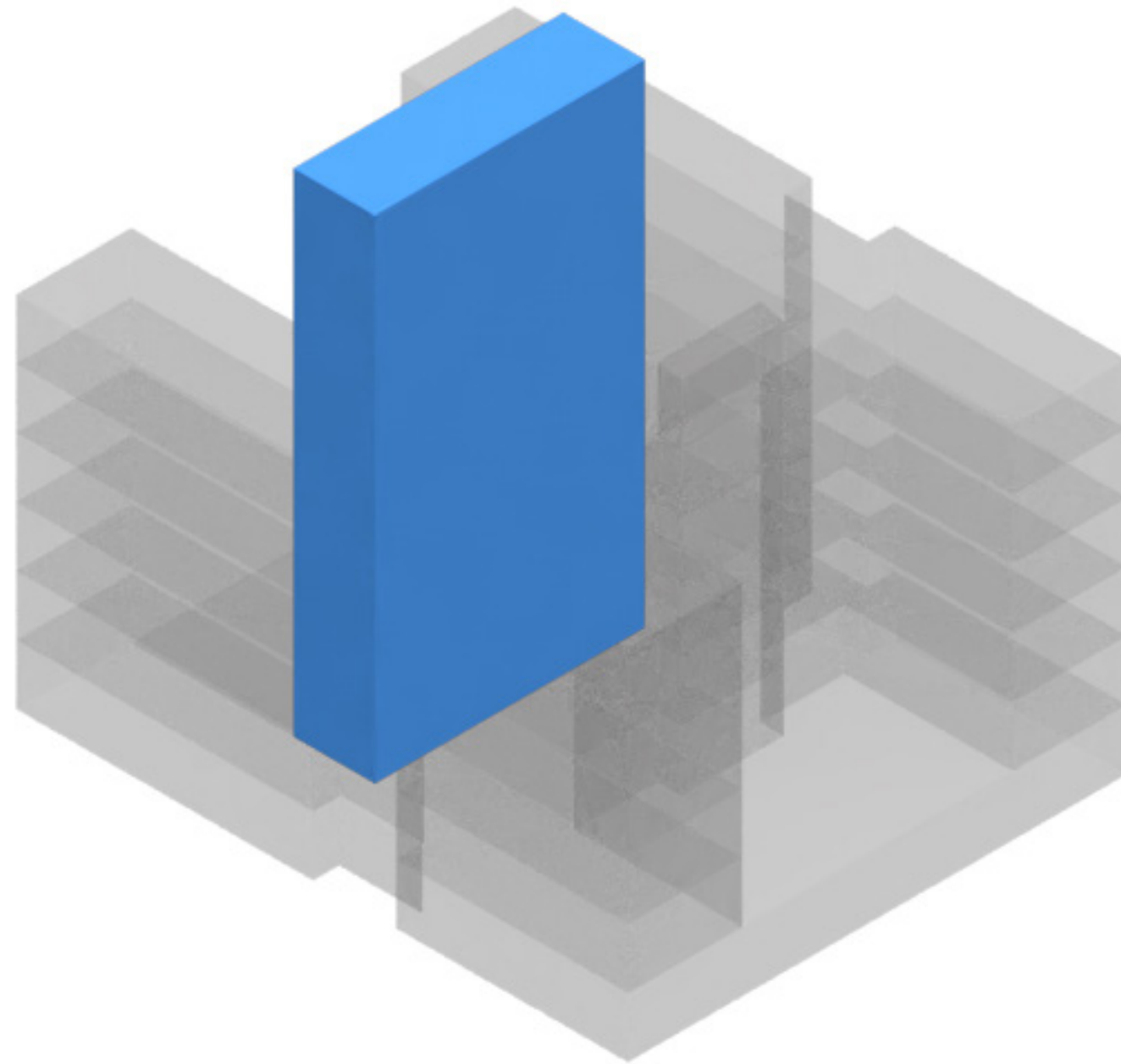

REAR ADDITION

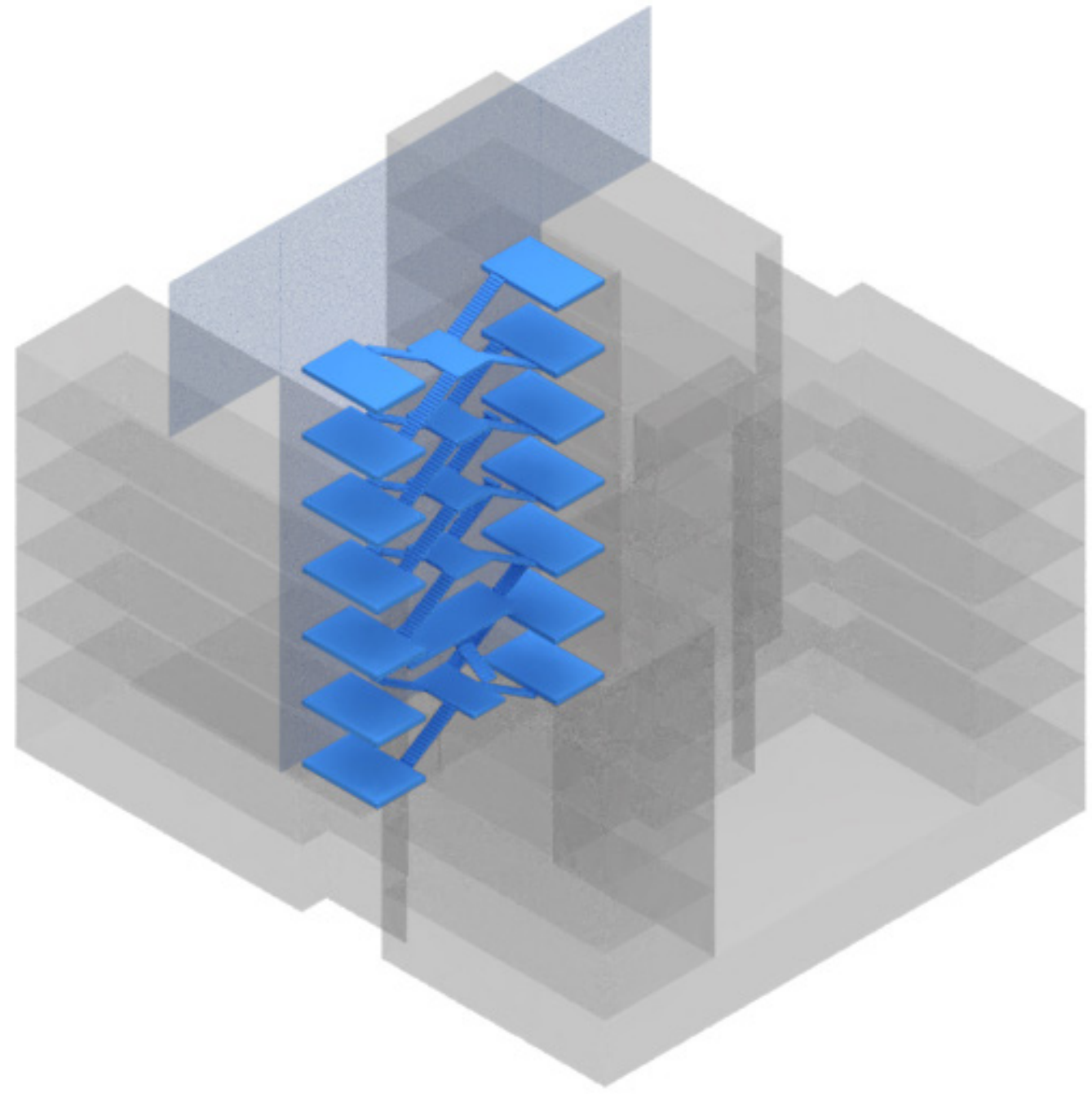

PROPOSED STAIRCASE

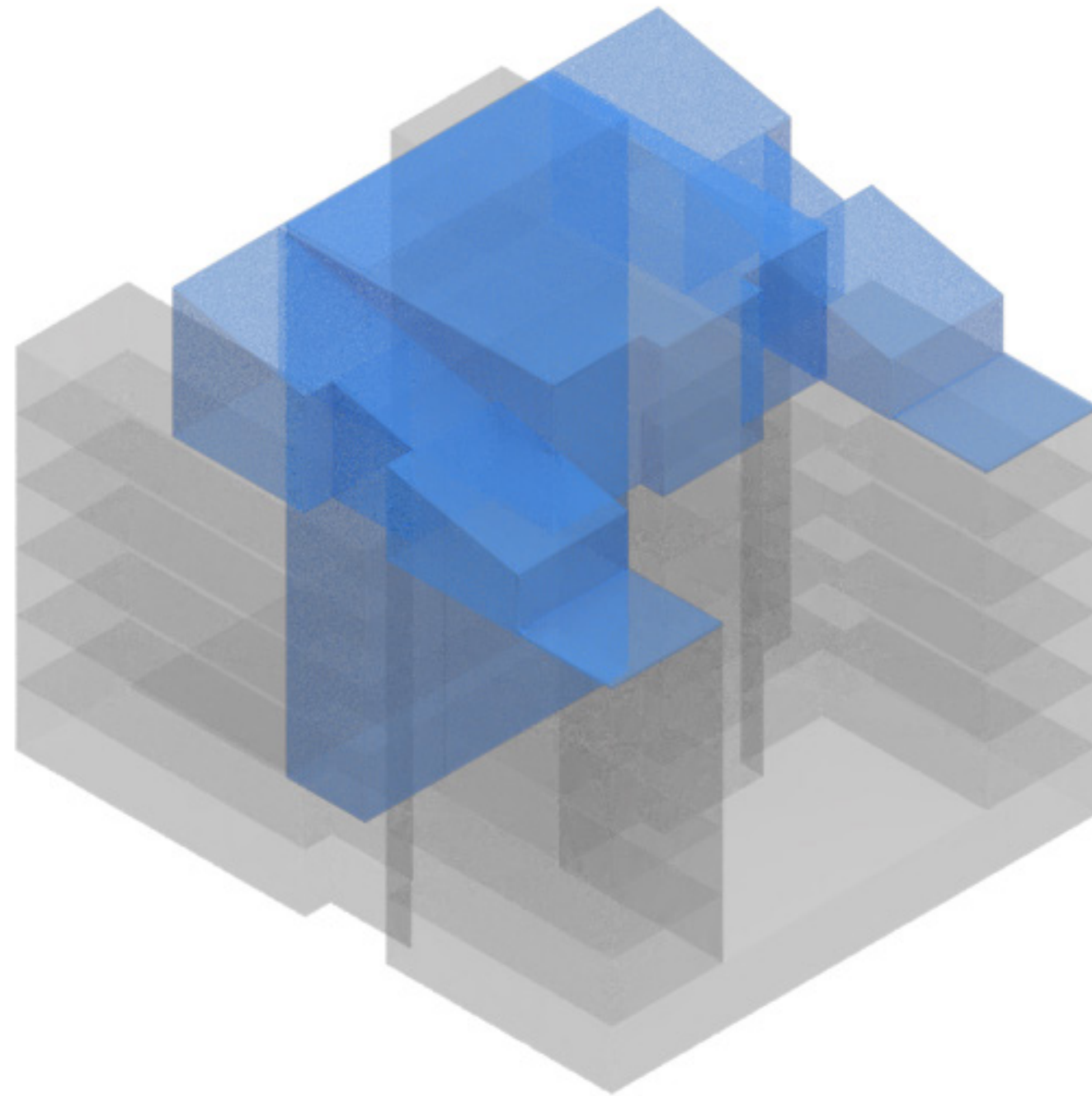

ADDITION MASSING

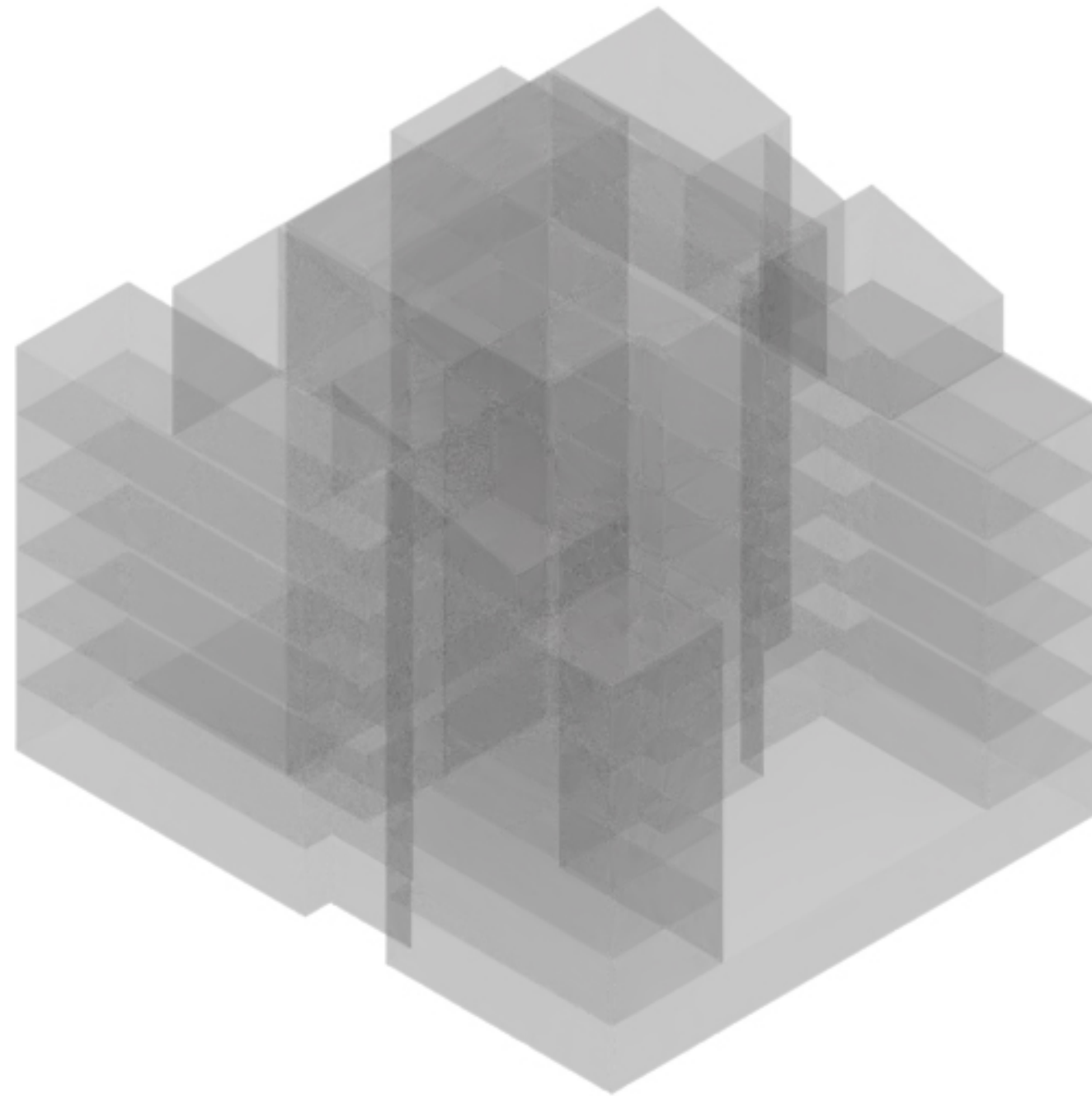

PROPOSED MASSING

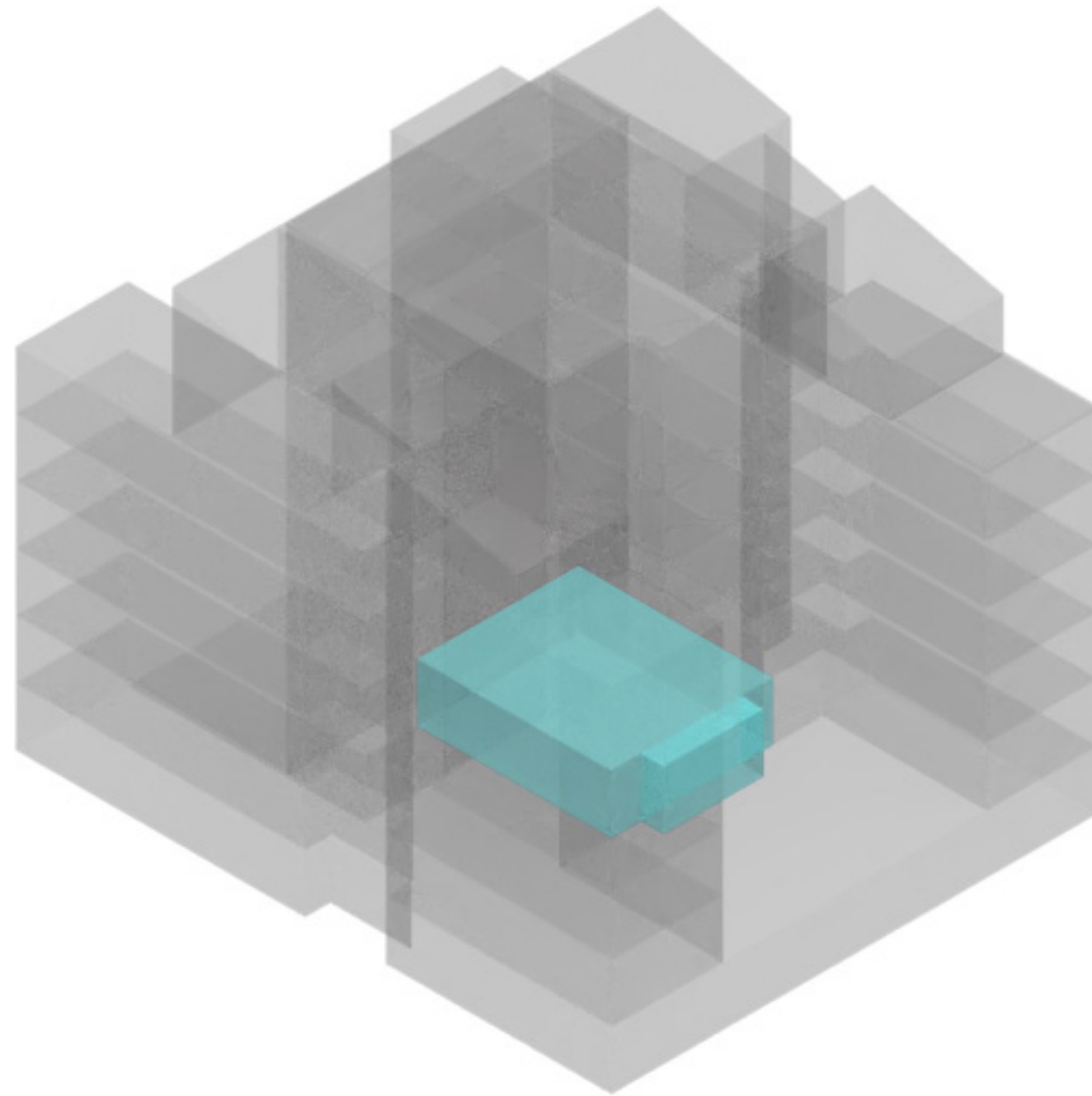

 LOBBY

LOBBY

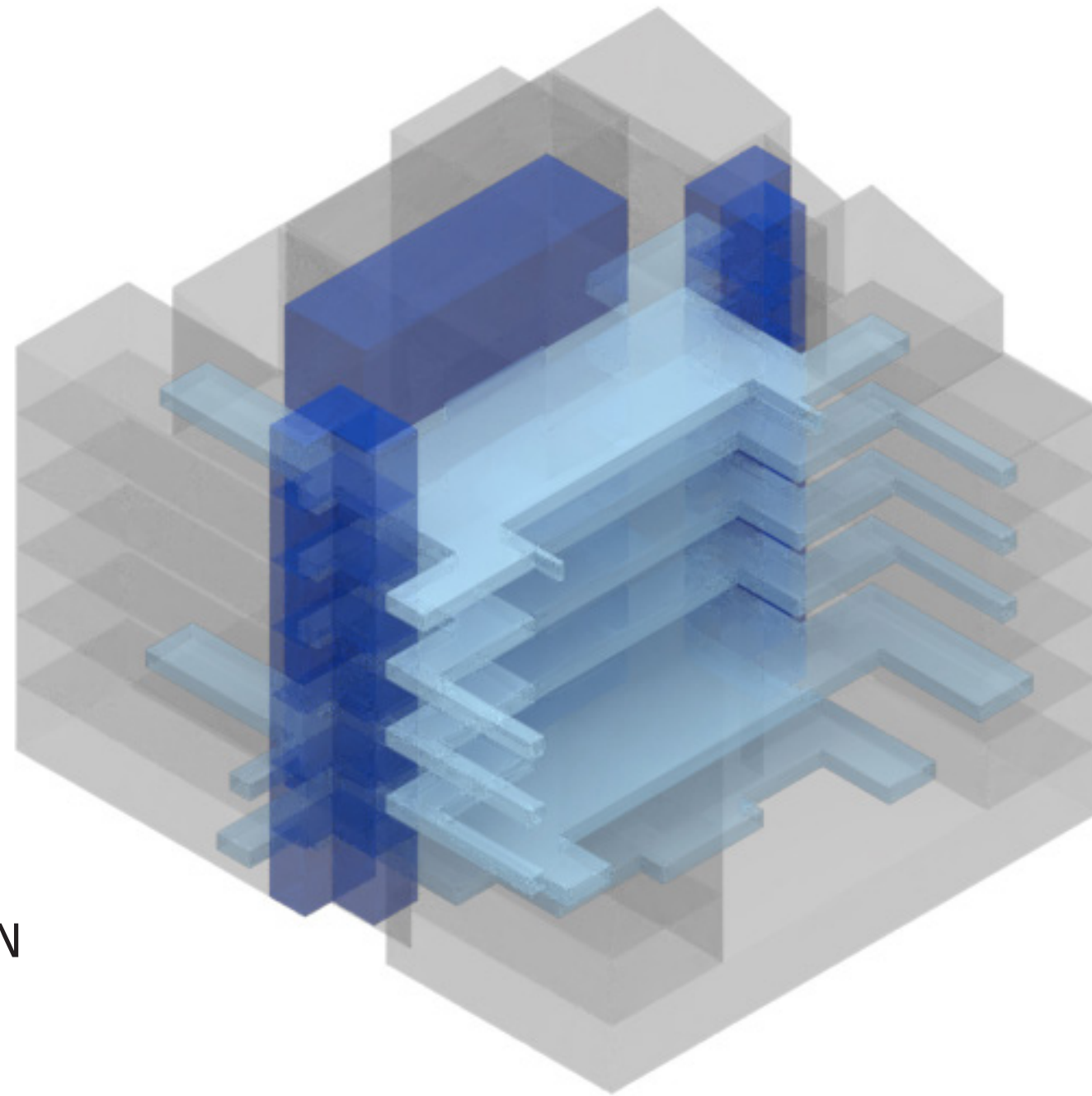

■ VERTICAL CIRCULATION
■ CORRIDOR

VERTICAL CIRCULATION & CORRIDORS

- ADMINISTRATIVE
- STUDENT SERVICES
- CUSTODIAL
- STORAGE

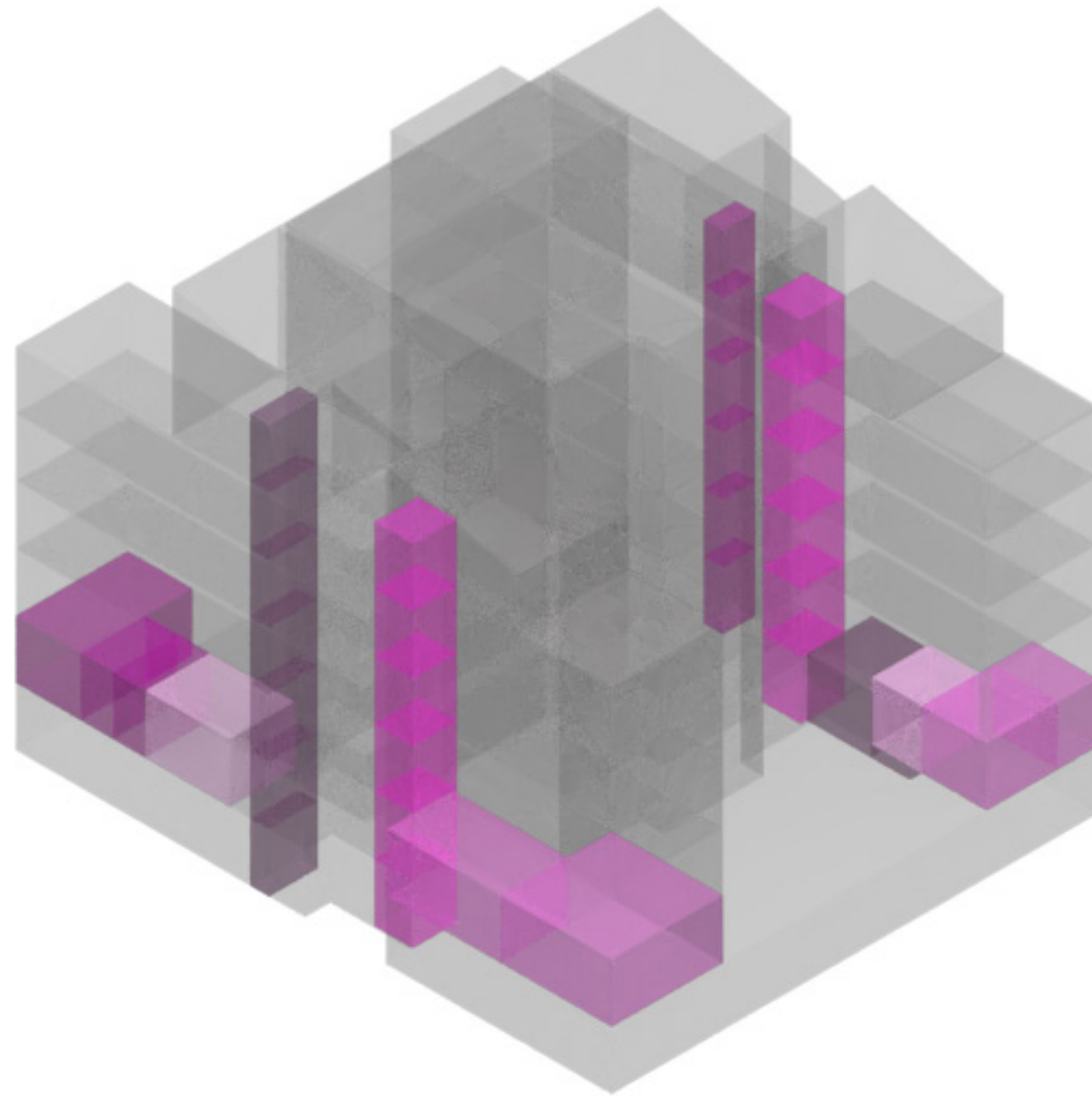

ADMINISTRATION & SERVICES

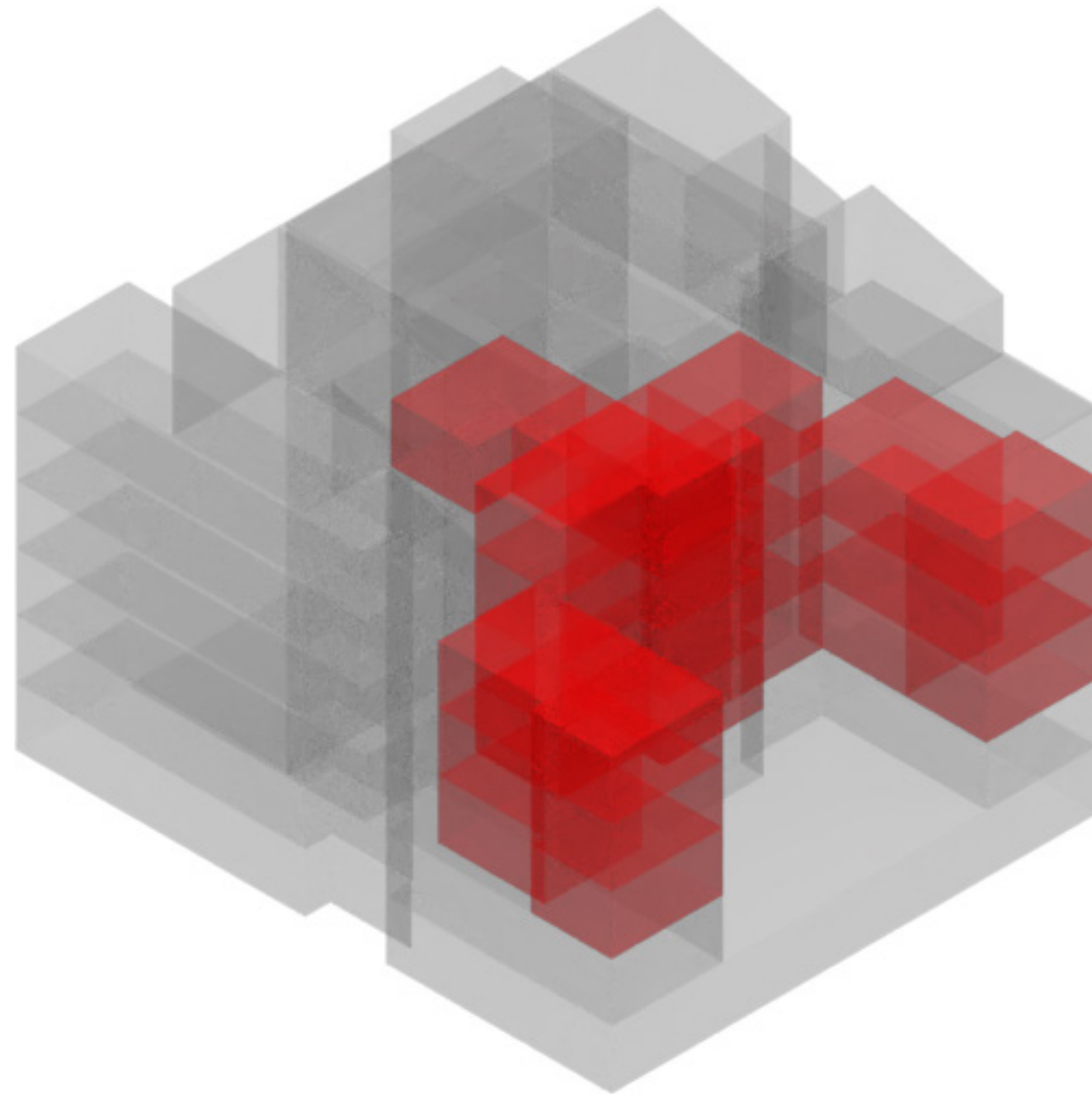

 CLASSROOMS

CLASSROOMS

- LIBRARY
- SCIENCE LABS
- SPECIALIZED INSTRUCTION

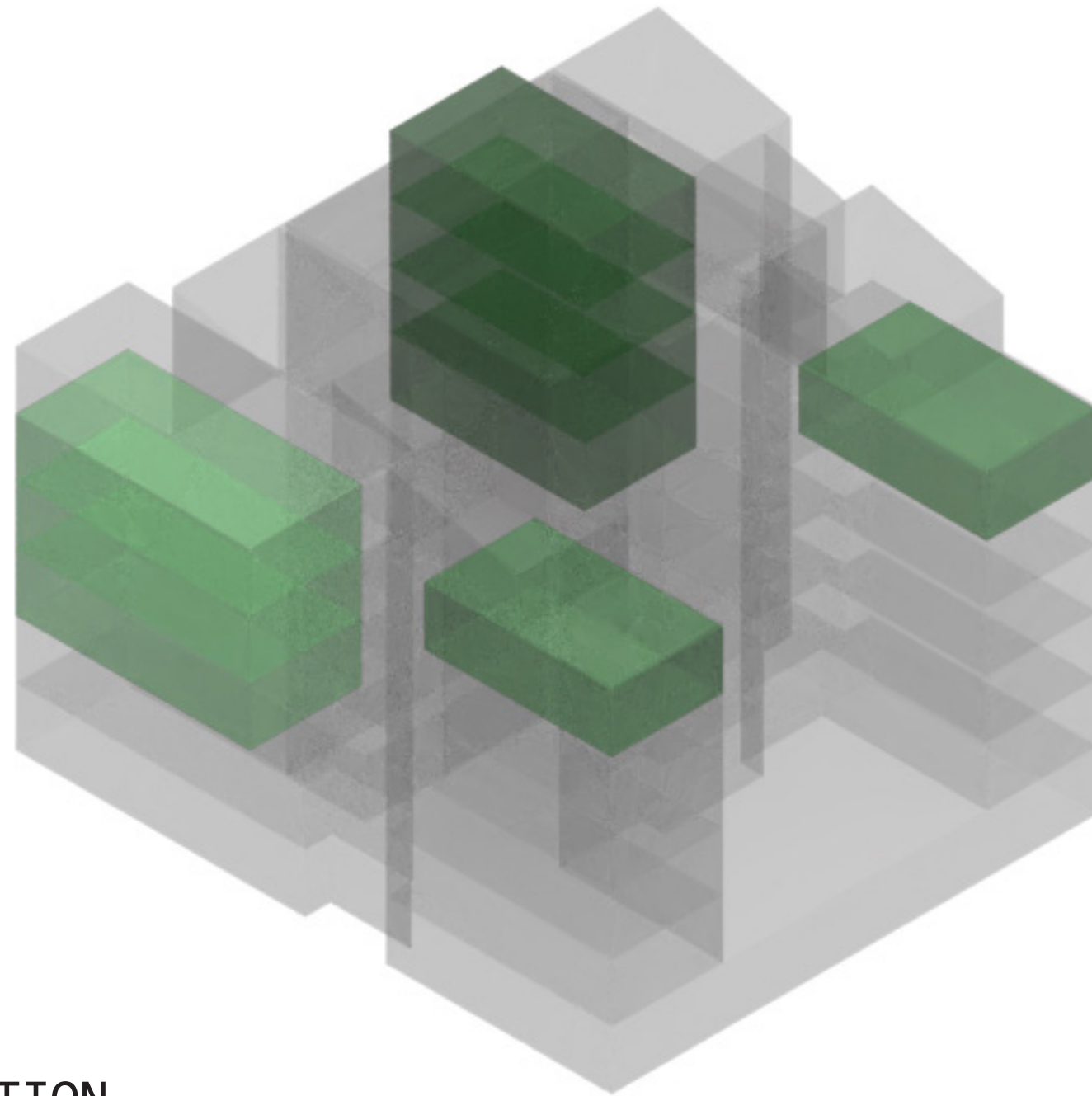

SPECIALIZED INSTRUCTION

- CAFETERIA / KITCHEN
- GREENHOUSE / URBAN FARM

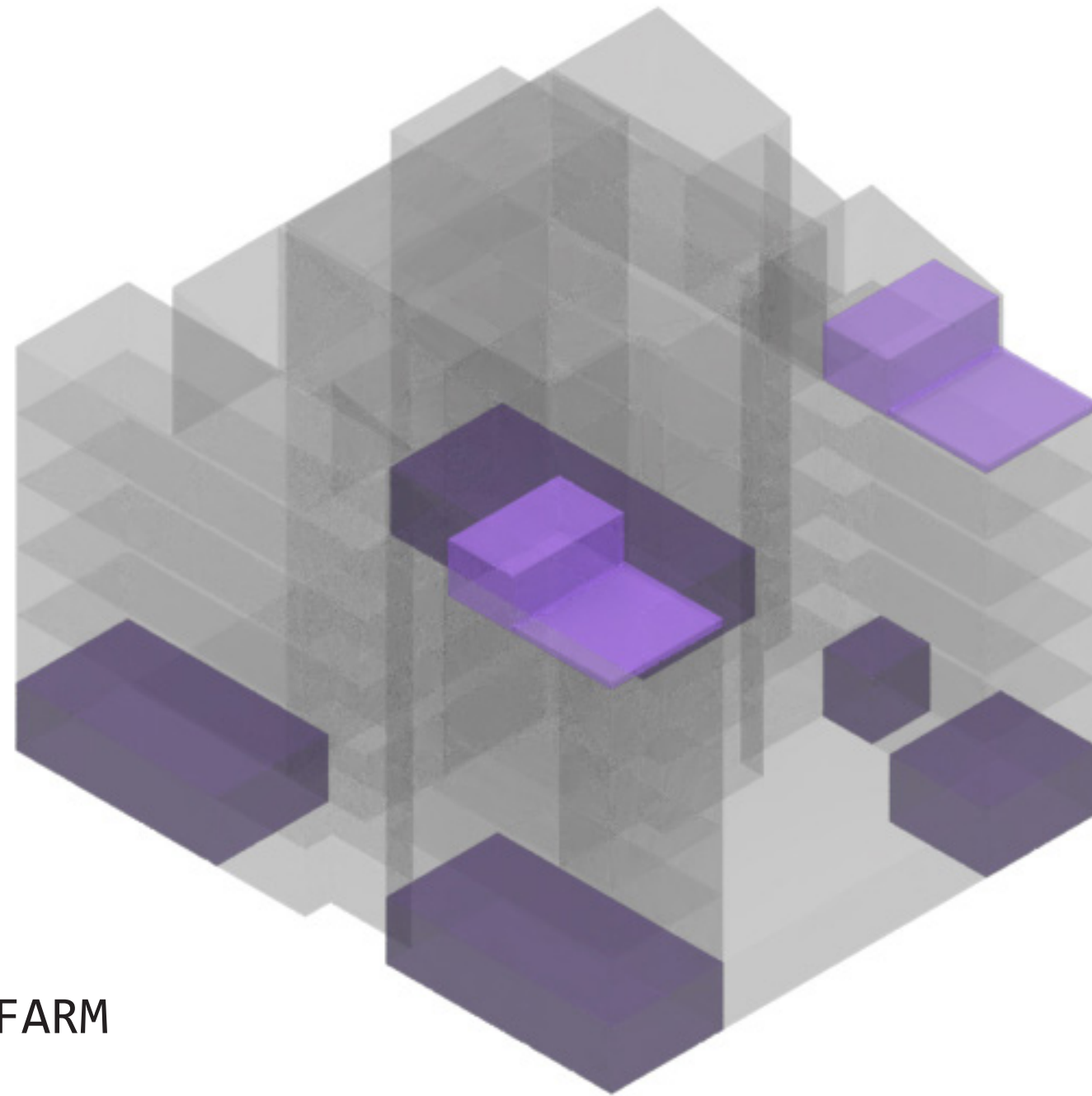

FOOD SERVICES

- GYMNASIUM
- AUDITORIUM

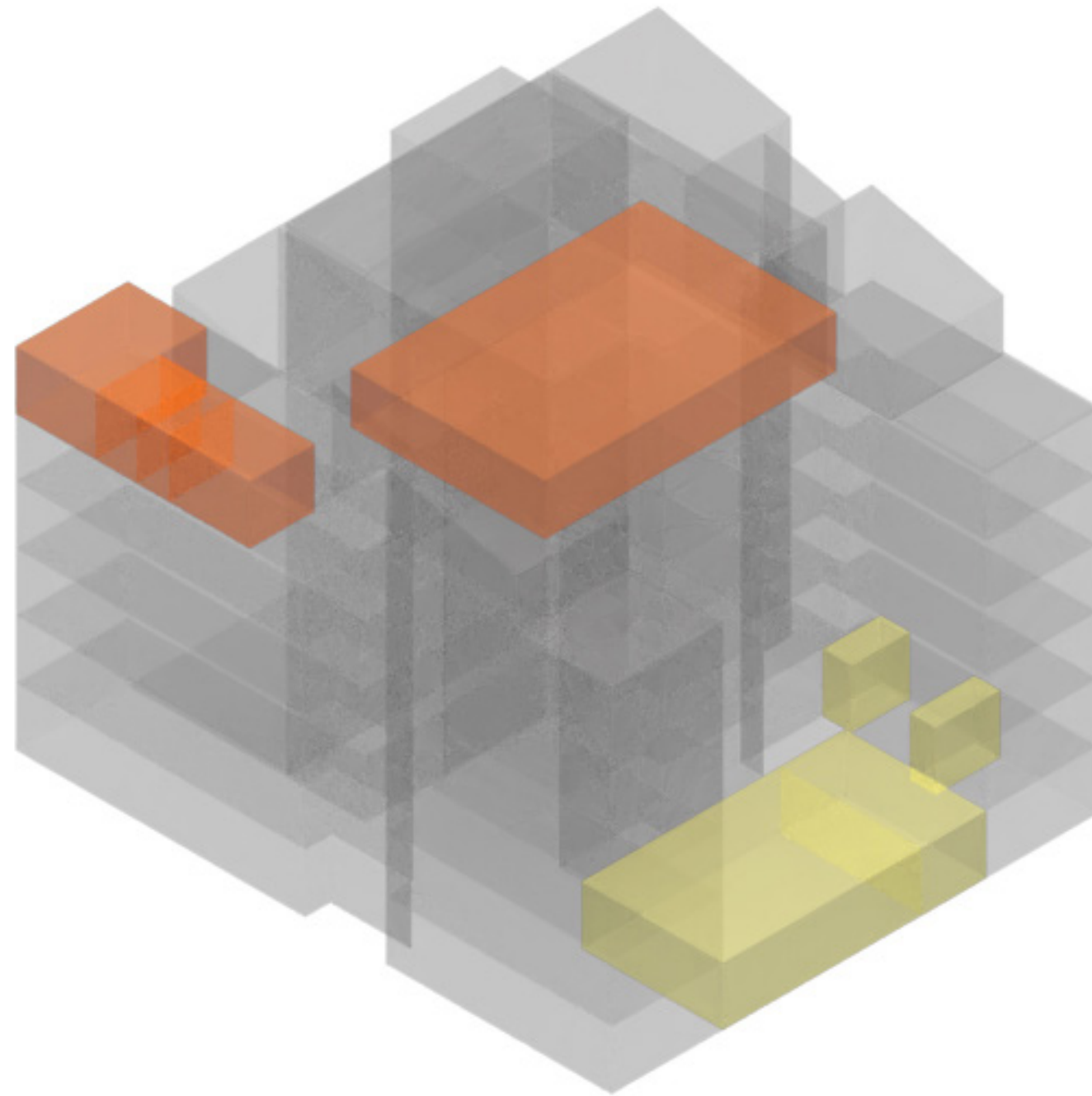

GYM & ASSEMBLY

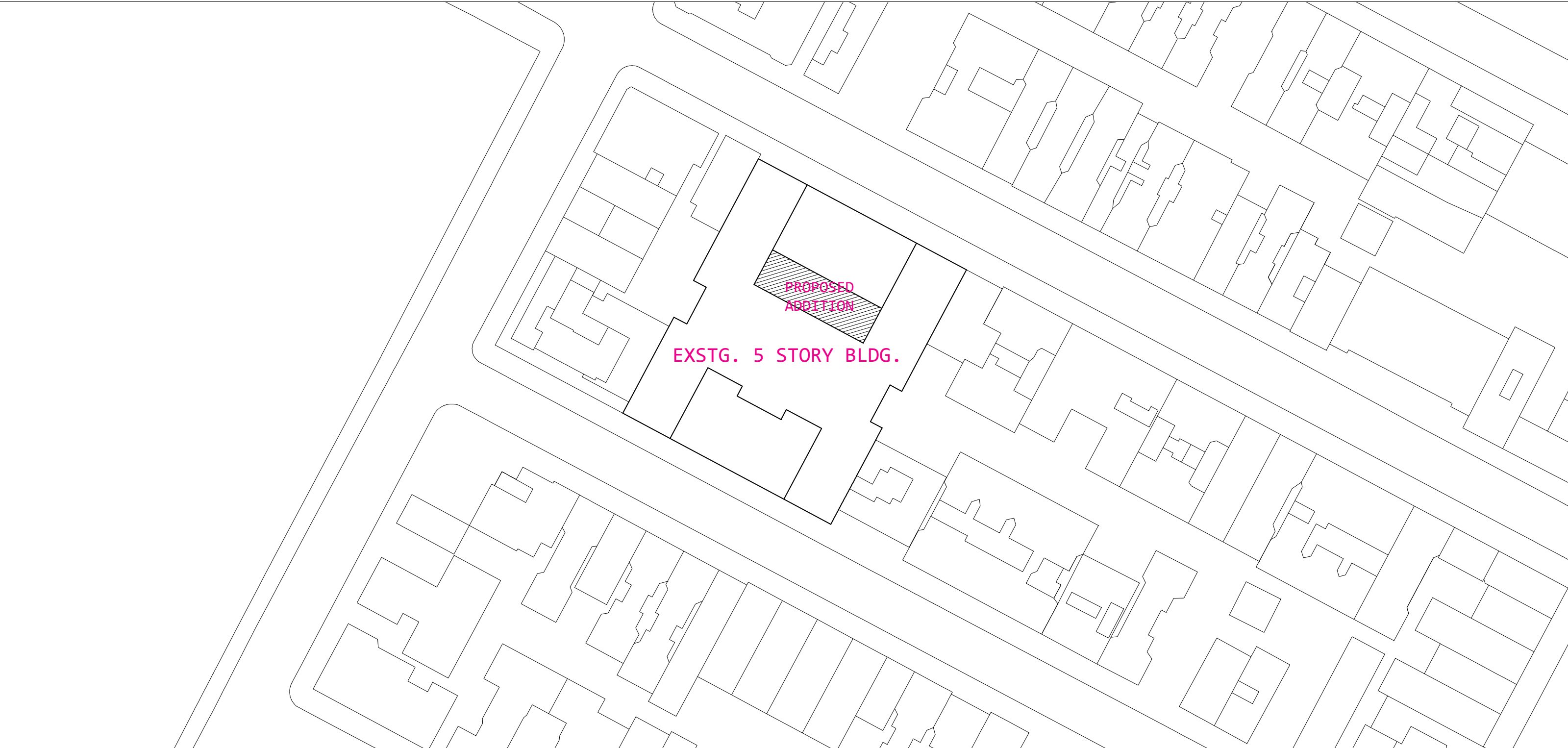

EXSTG. 5 STORY BLDG.

PROPOSED
ADDITION

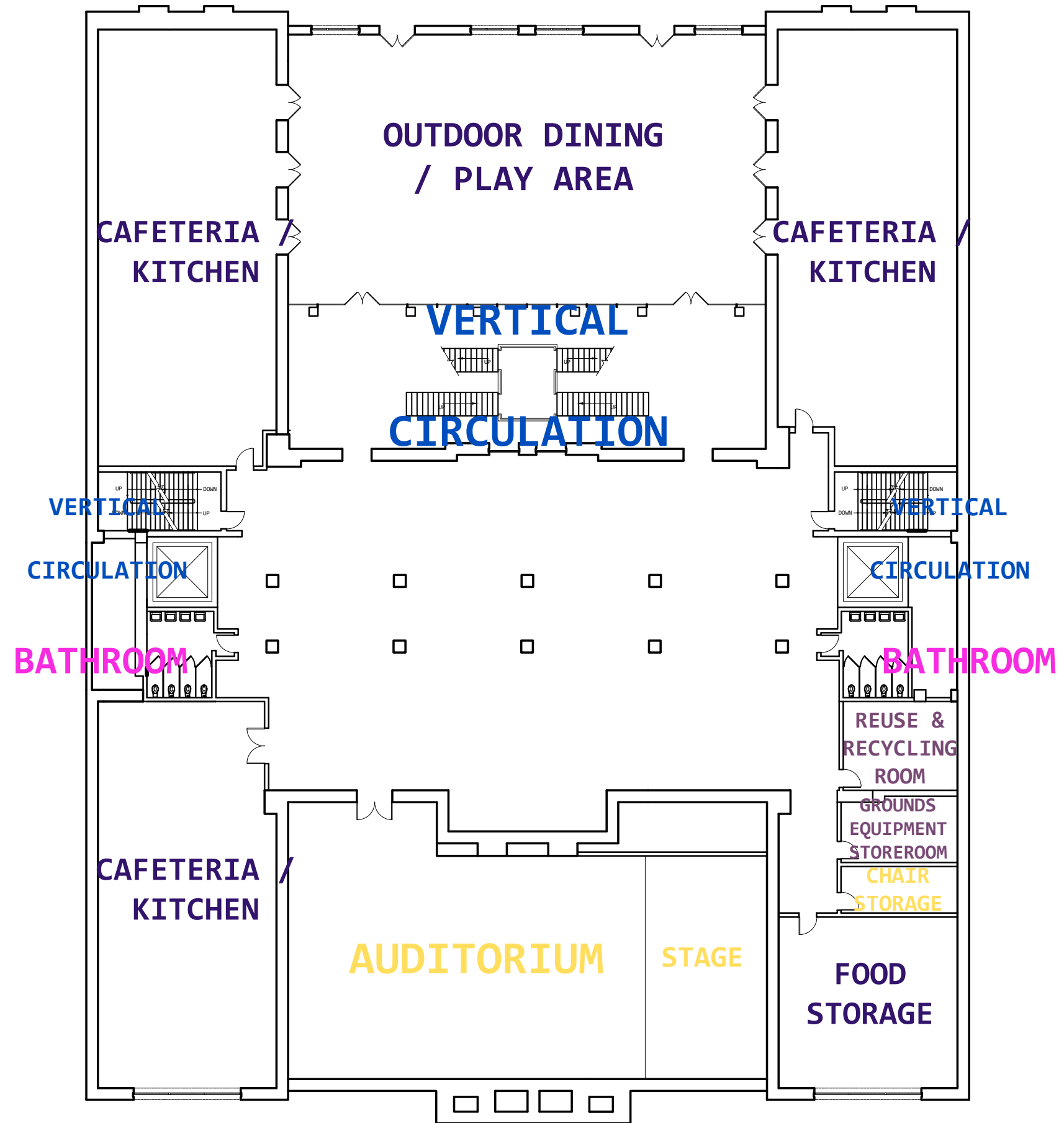

⊗ CELLAR FLOOR PLAN

E. 10th STREET

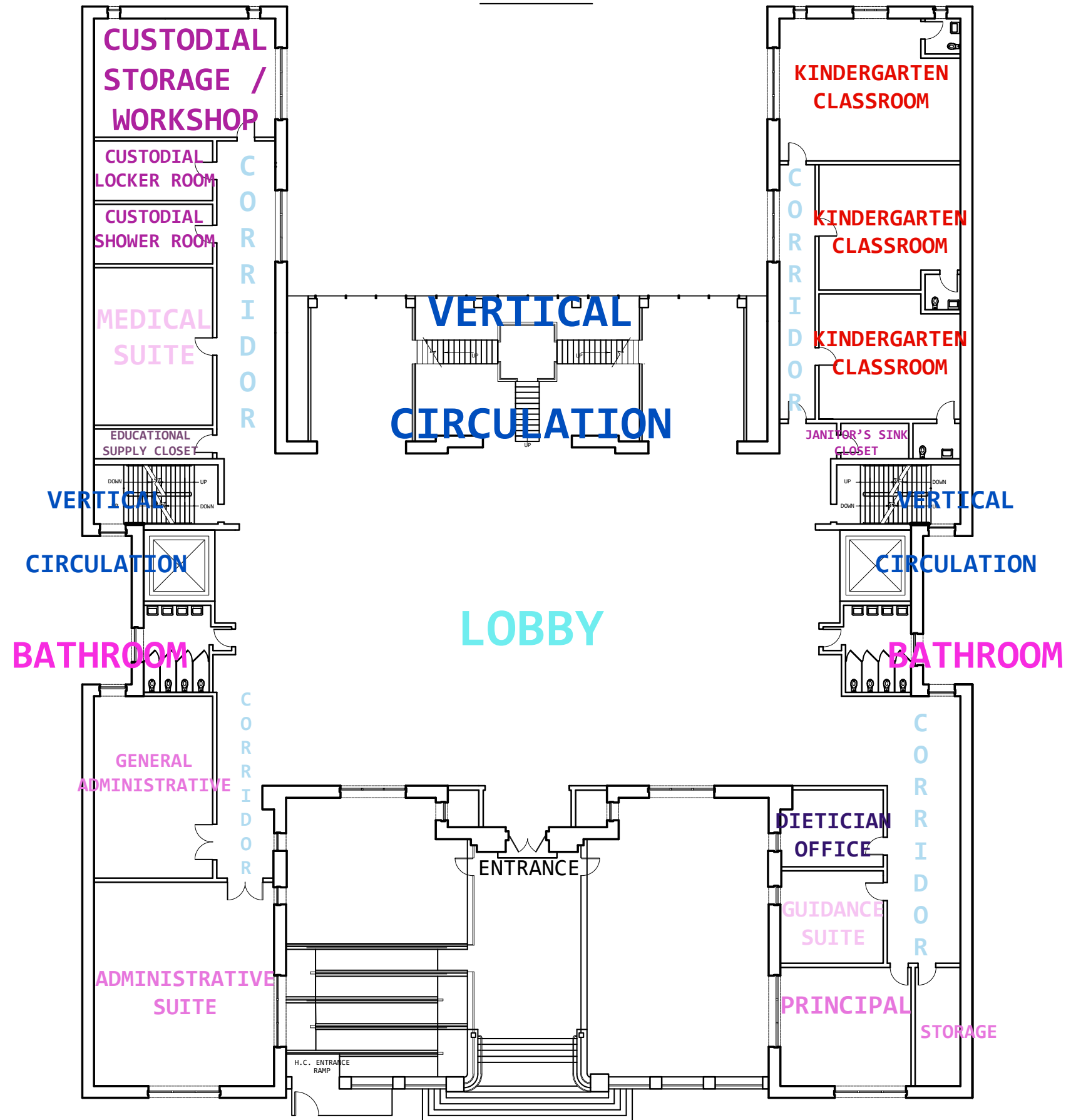

BATHROOM

LOBBY

BATHROOM

⊗ FIRST FLOOR PLAN

E. 9th STREET

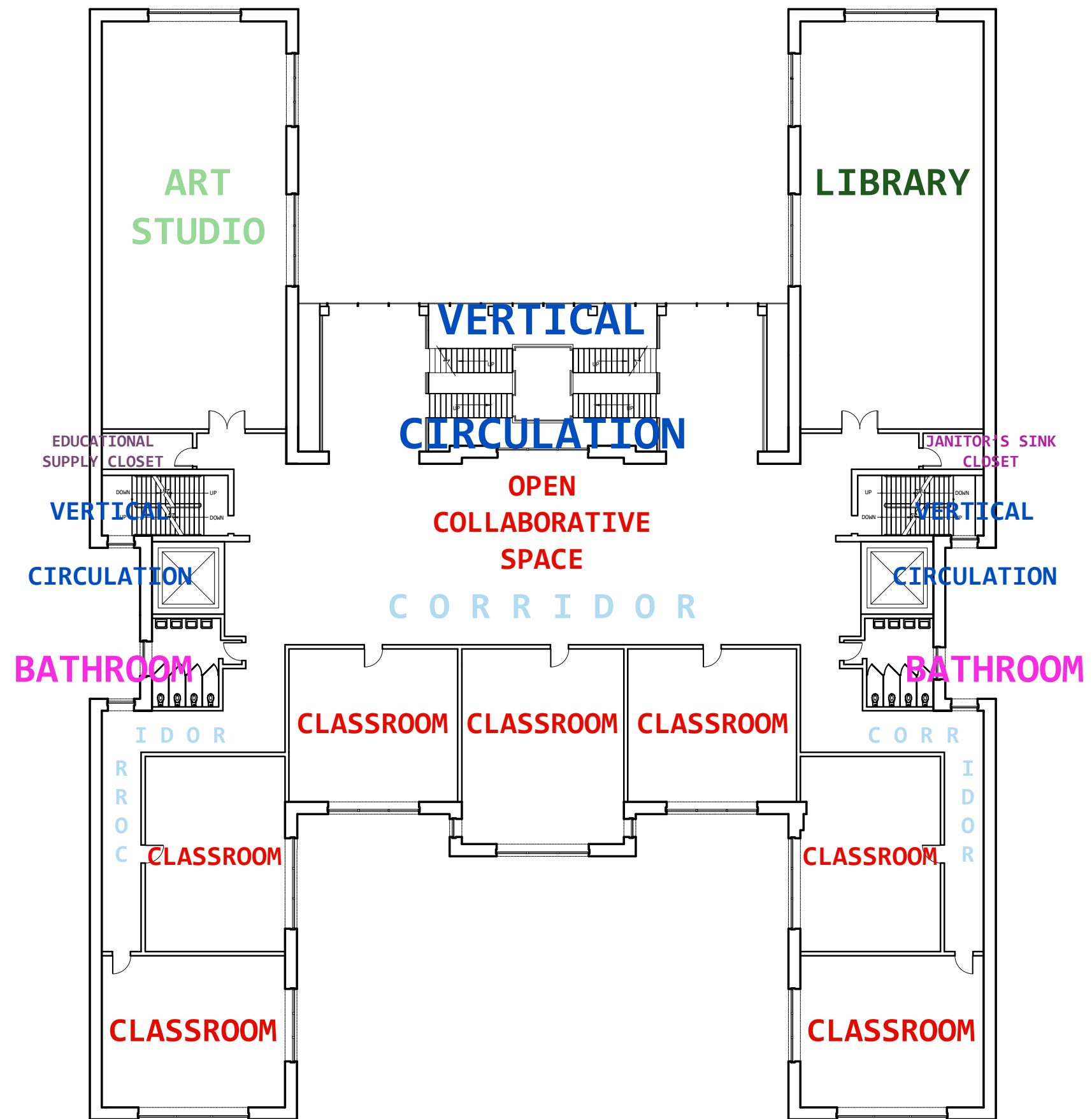

⊗ SECOND FLOOR PLAN

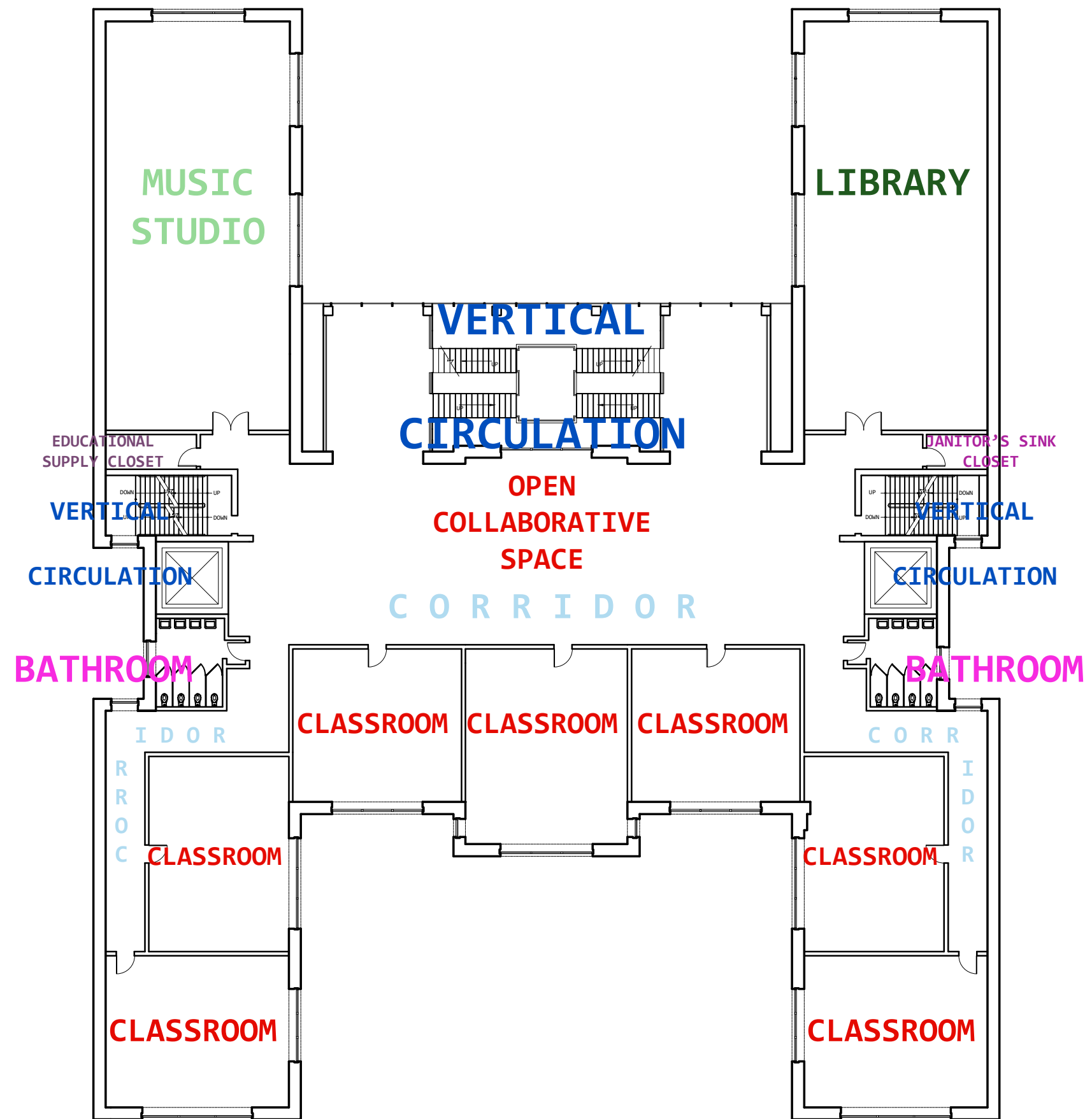

⊗ THIRD FLOOR PLAN

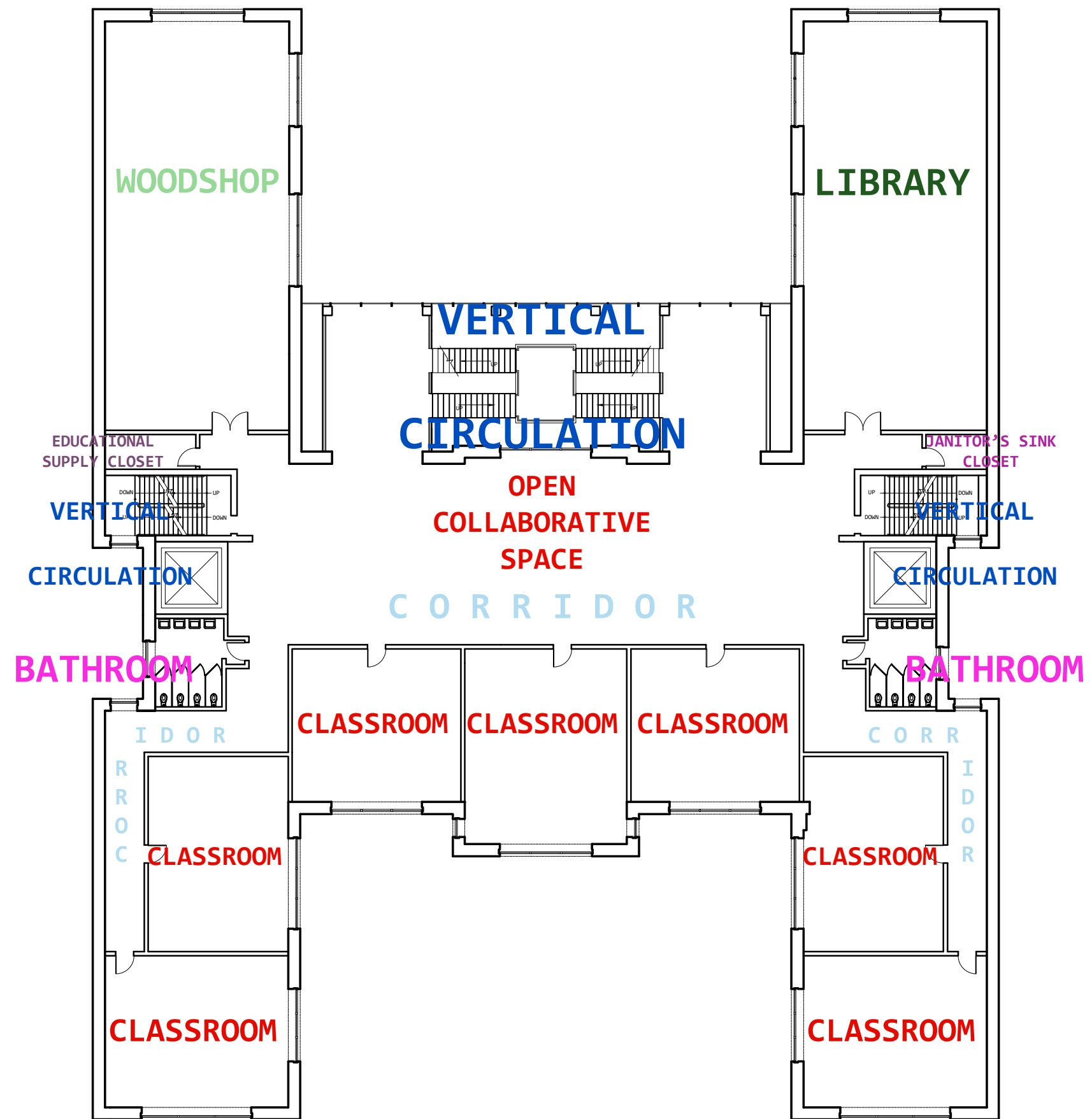

⊗ FOURTH FLOOR PLAN

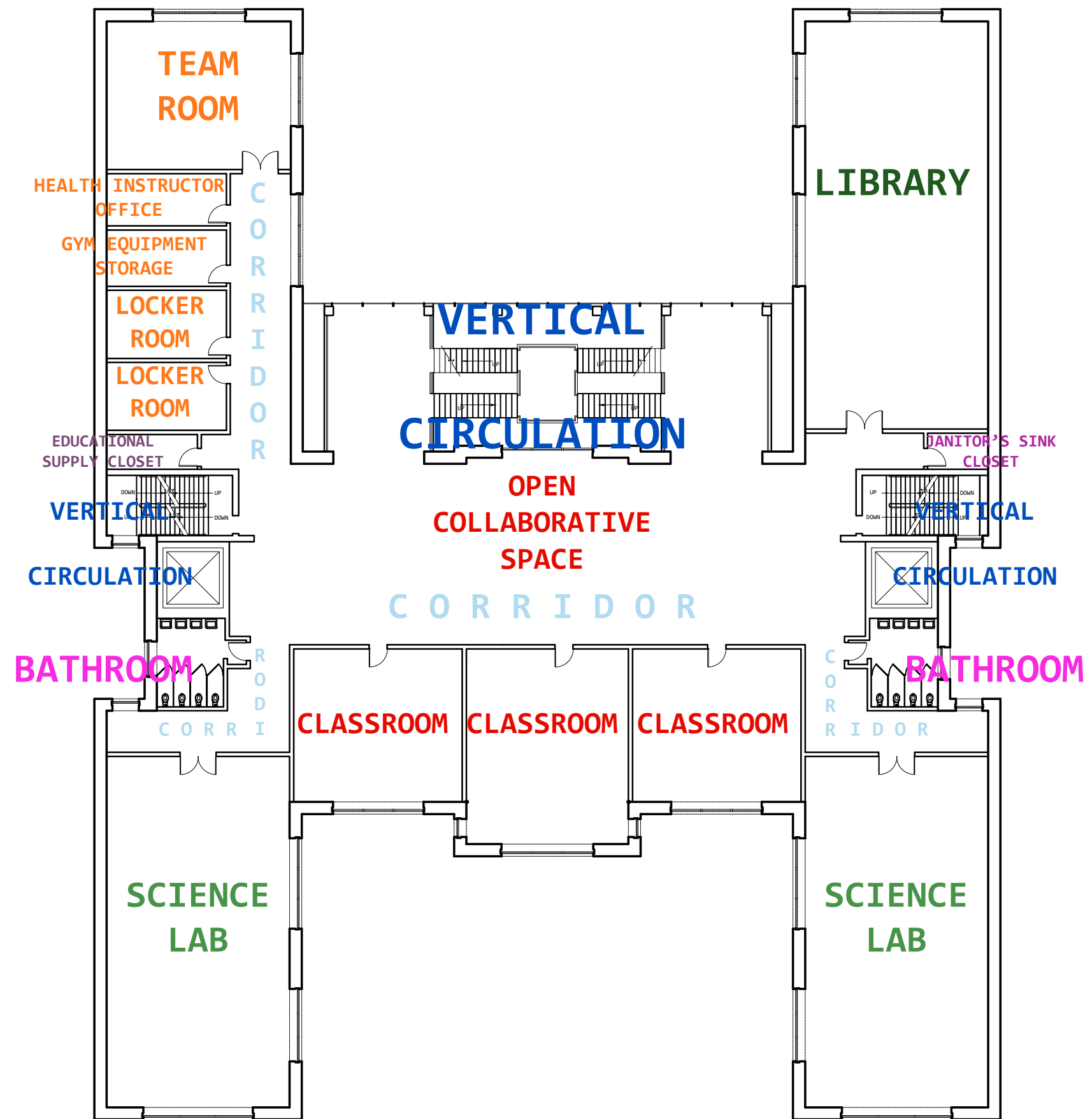

⊗ FIFTH FLOOR PLAN

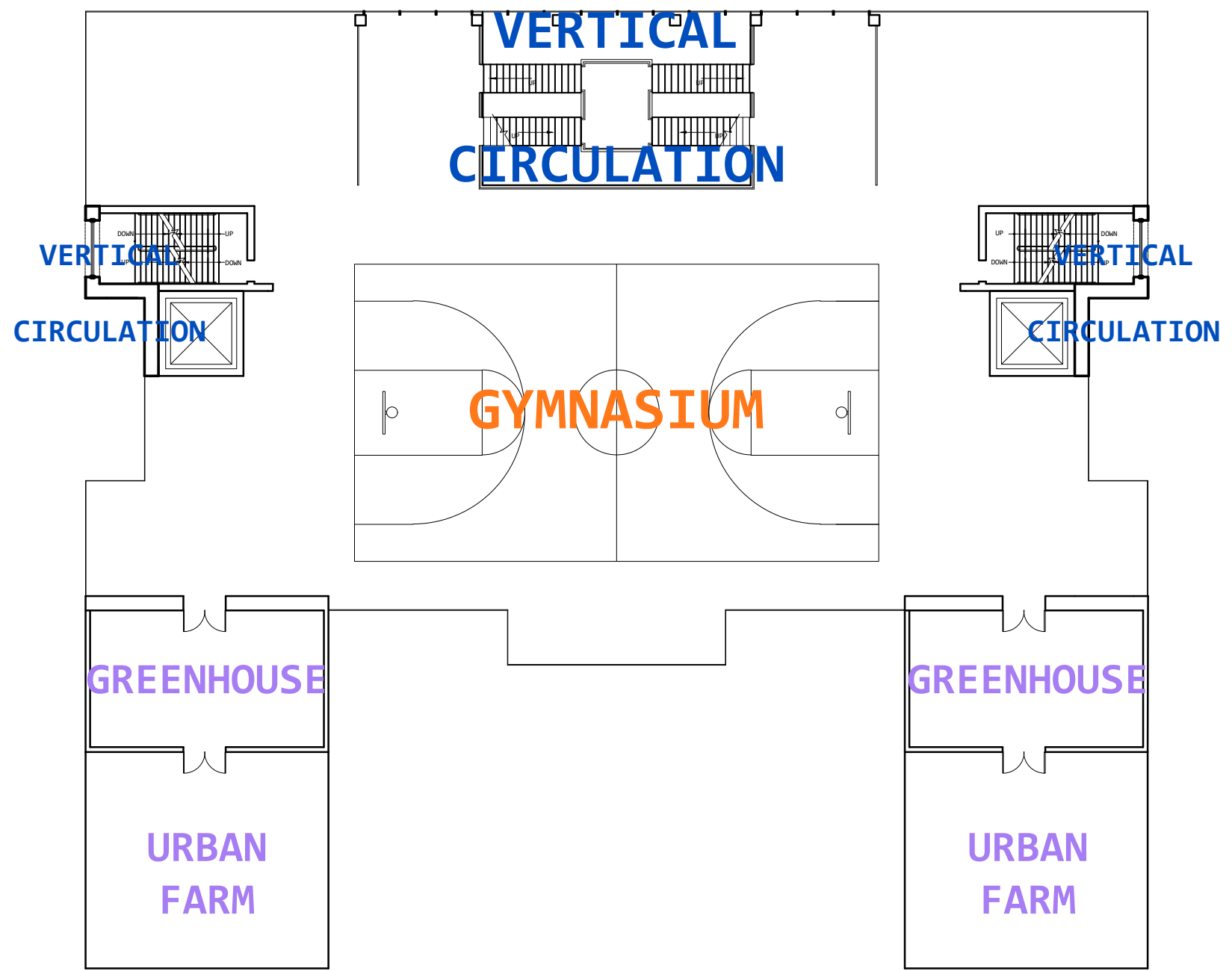

⊗ SIXTH FLOOR PLAN

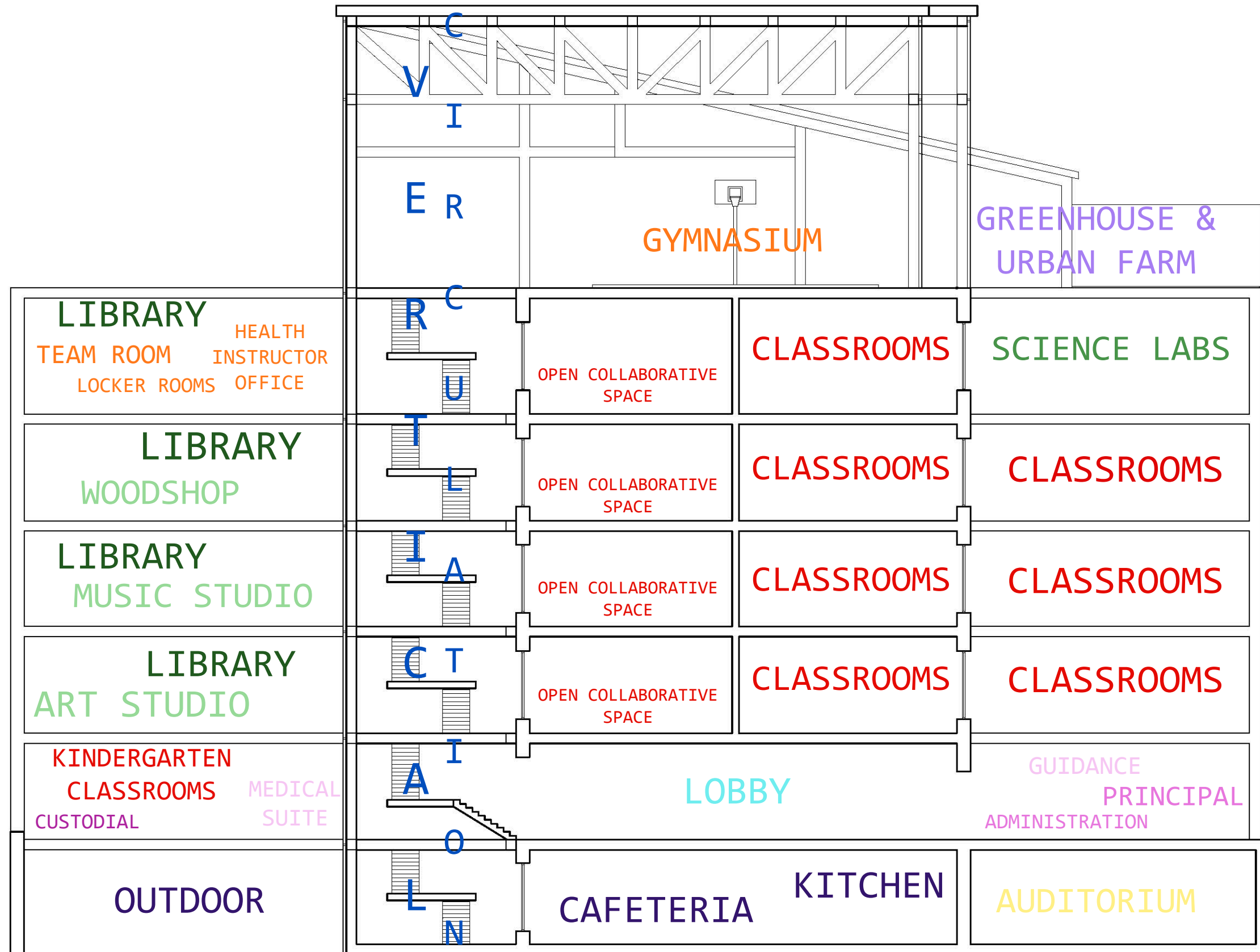

PROGRAM: WEEKDAY

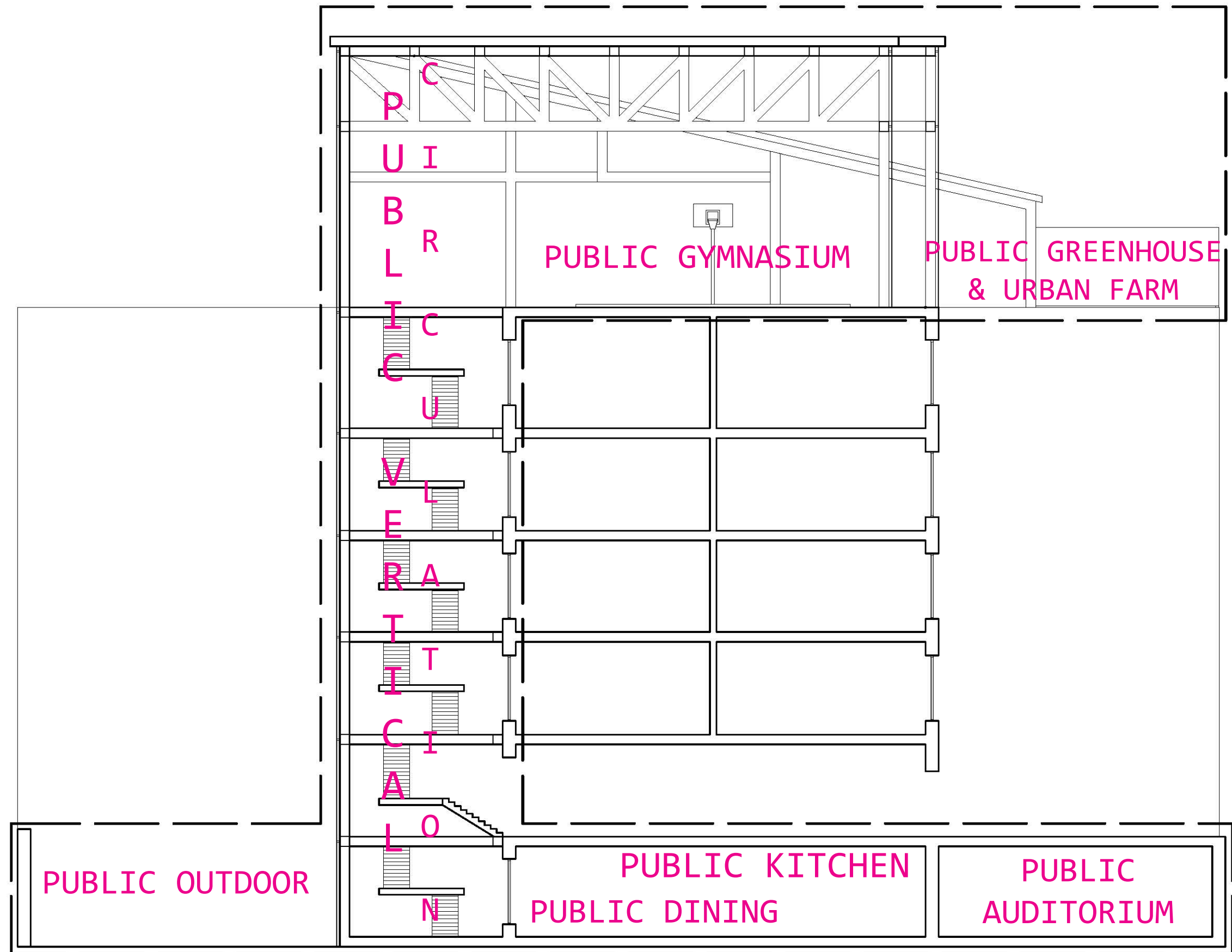

PROGRAM: WEEKEND

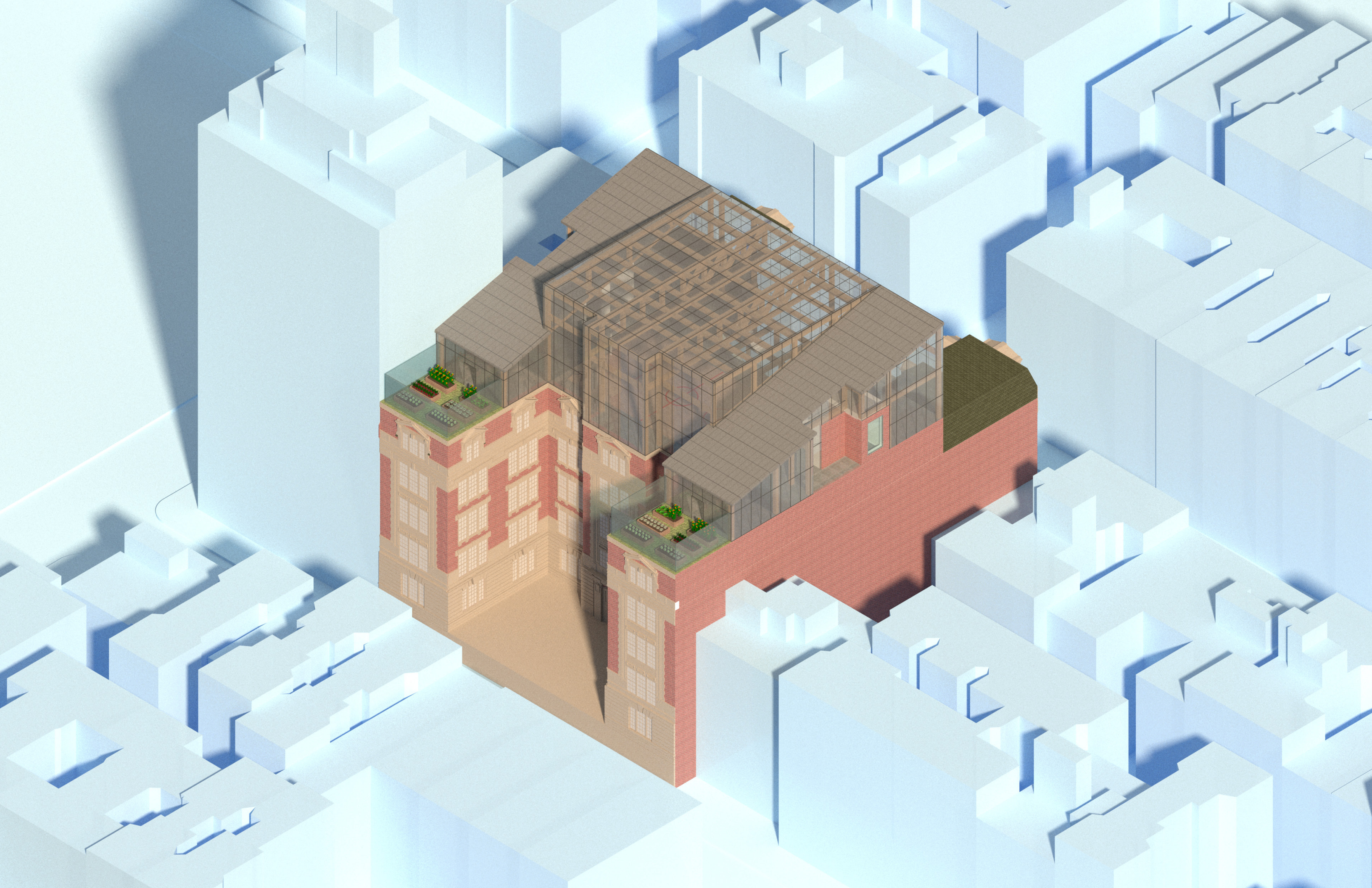

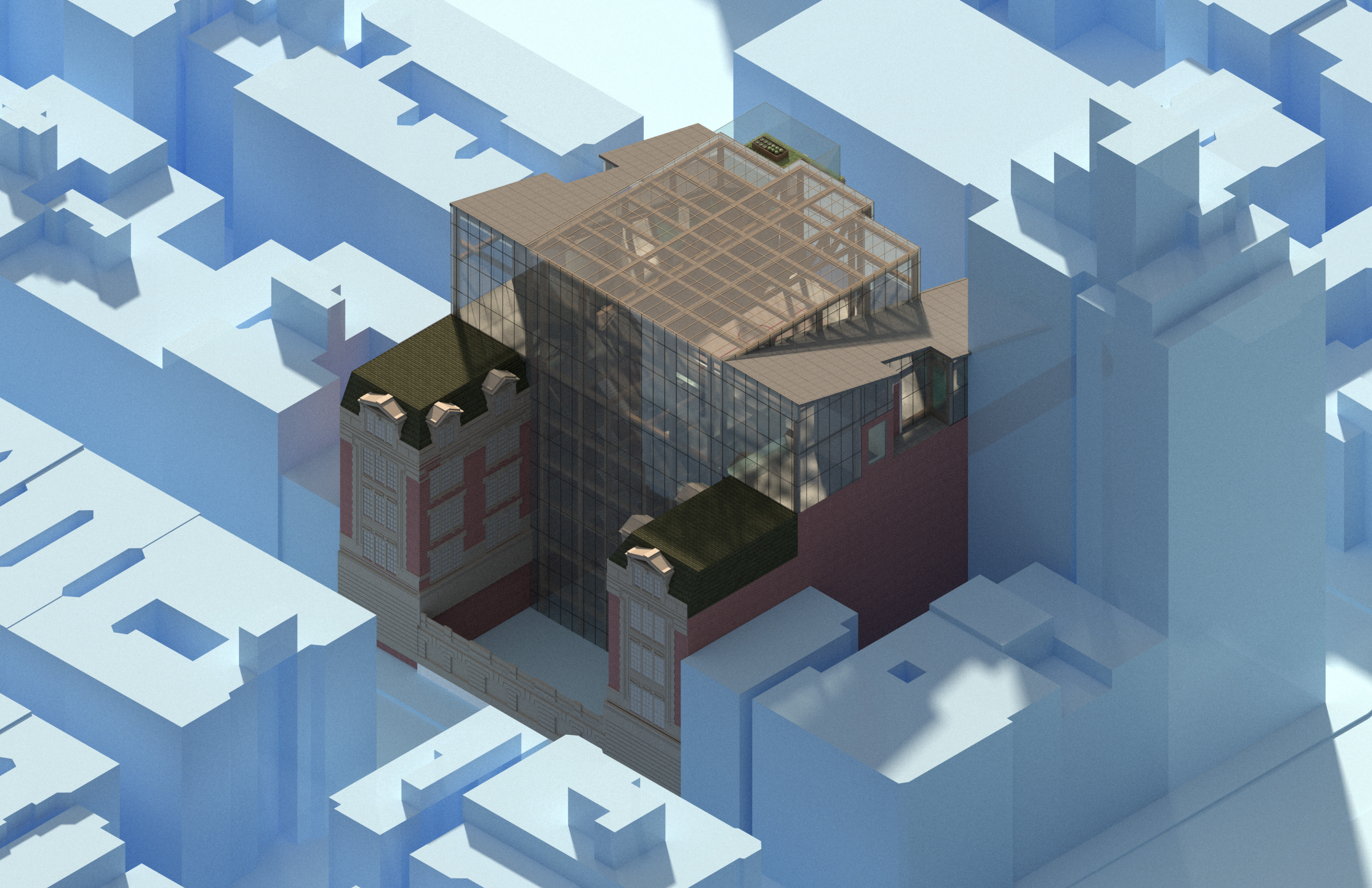

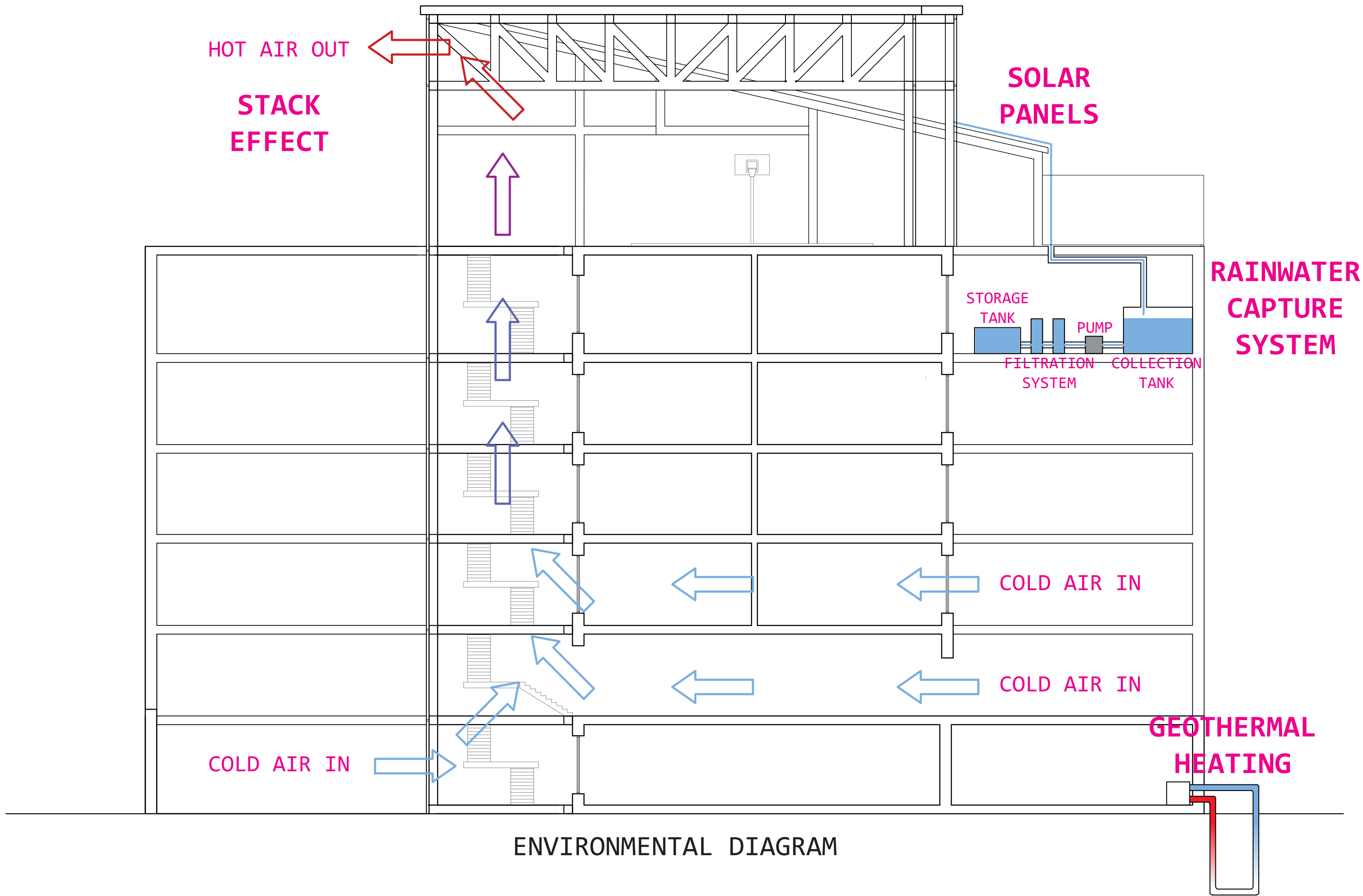

HOT AIR OUT

STACK EFFECT

SOLAR PANELS

RAINWATER CAPTURE SYSTEM

STORAGE TANK
FILTRATION SYSTEM
PUMP
COLLECTION TANK

COLD AIR IN

COLD AIR IN

COLD AIR IN

GEOHERMAL HEATING

ENVIRONMENTAL DIAGRAM

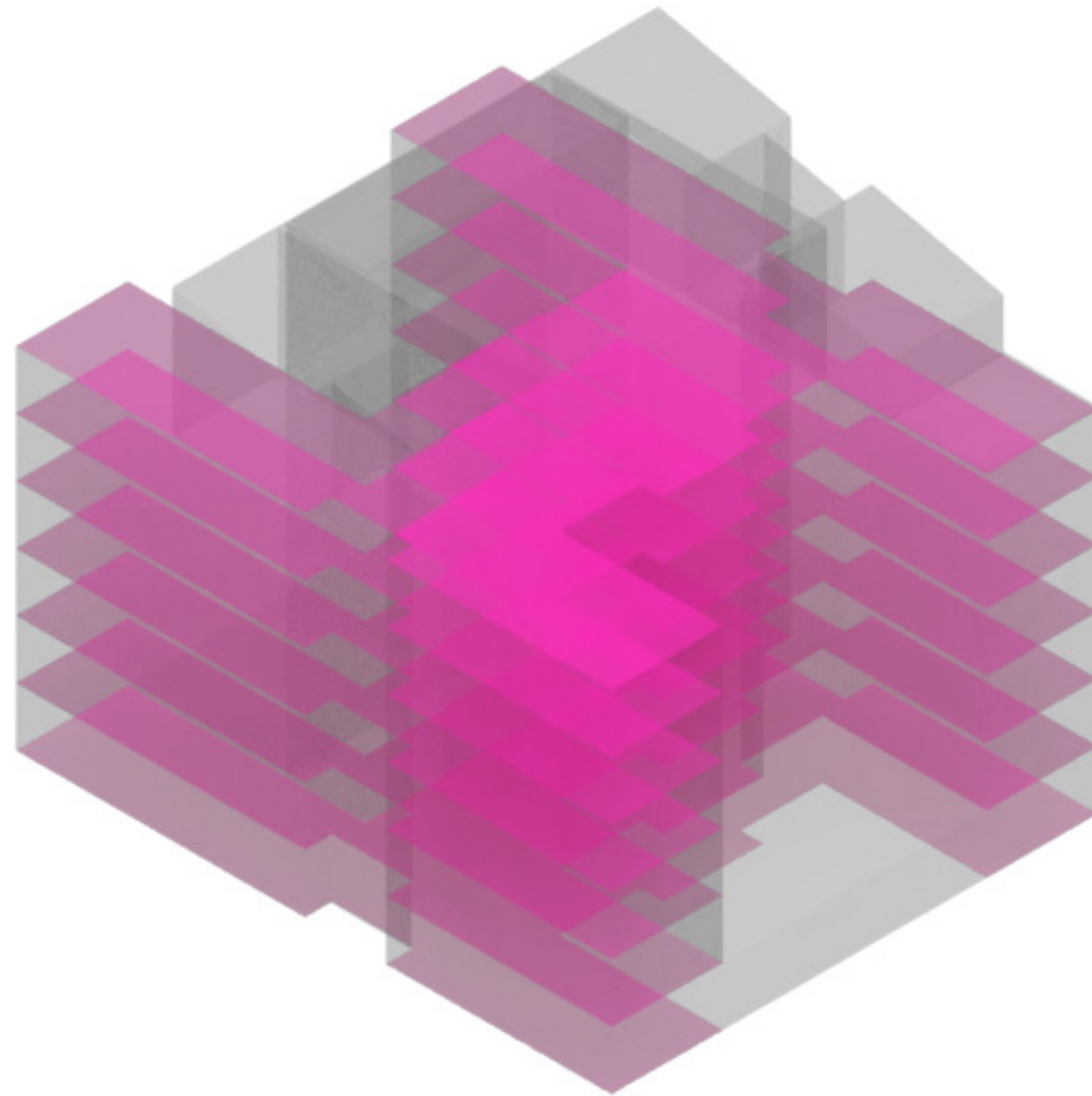

EXISTING STRUCTURE: FLOOR PLATES

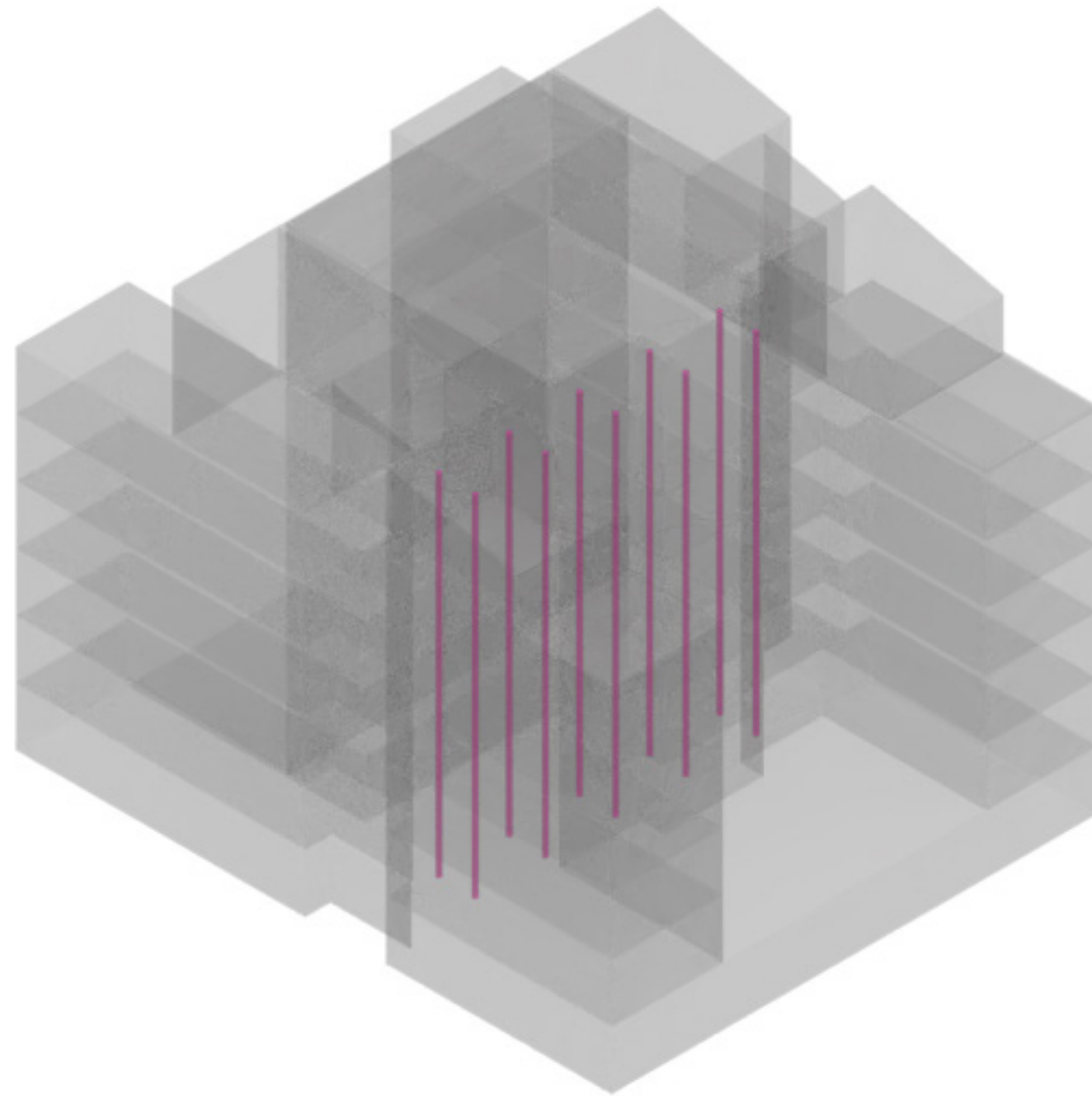

EXISTING STRUCTURE: COLUMNS

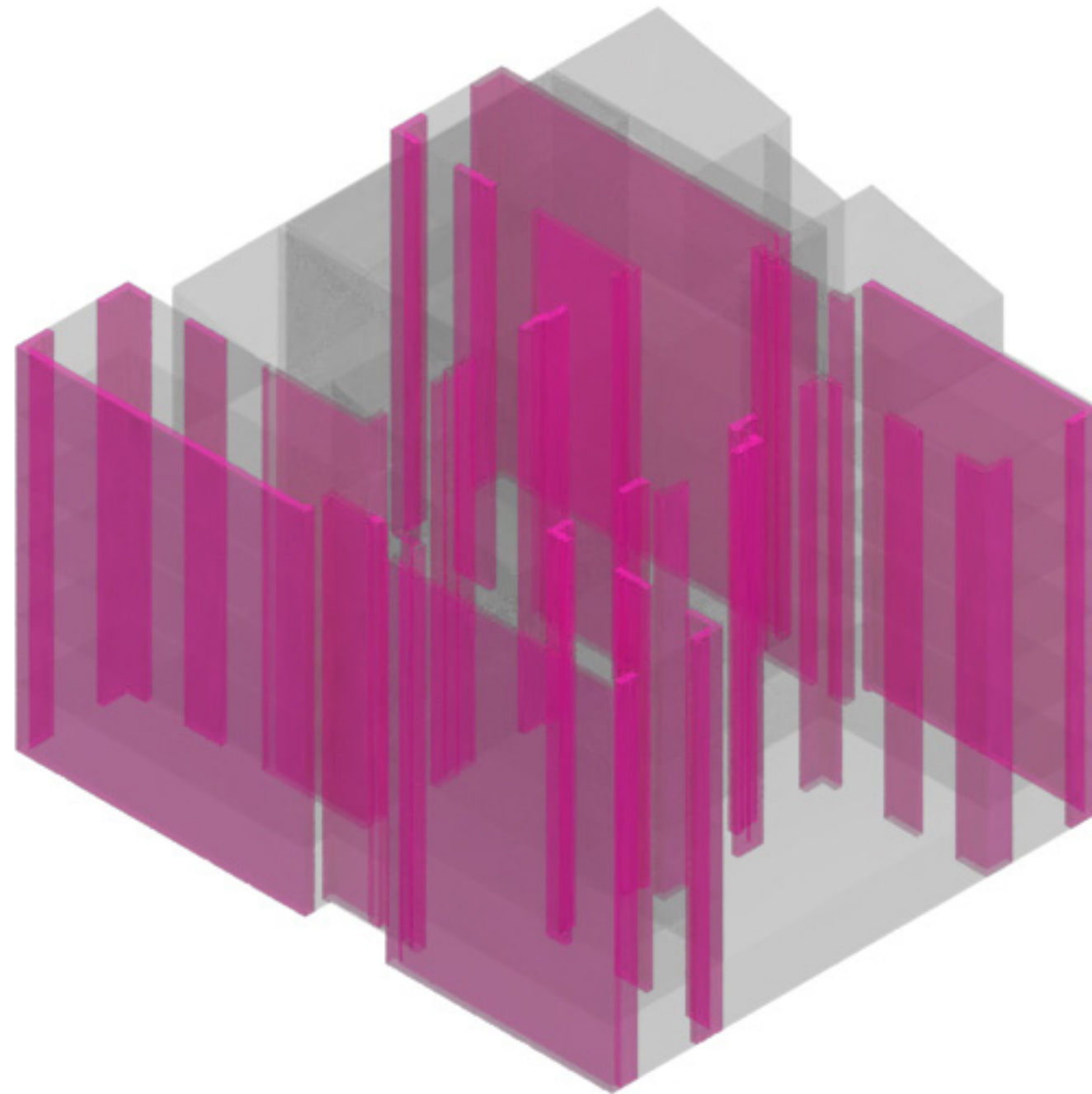

EXISTING STRUCTURE: VERTICAL MASONRY WALLS

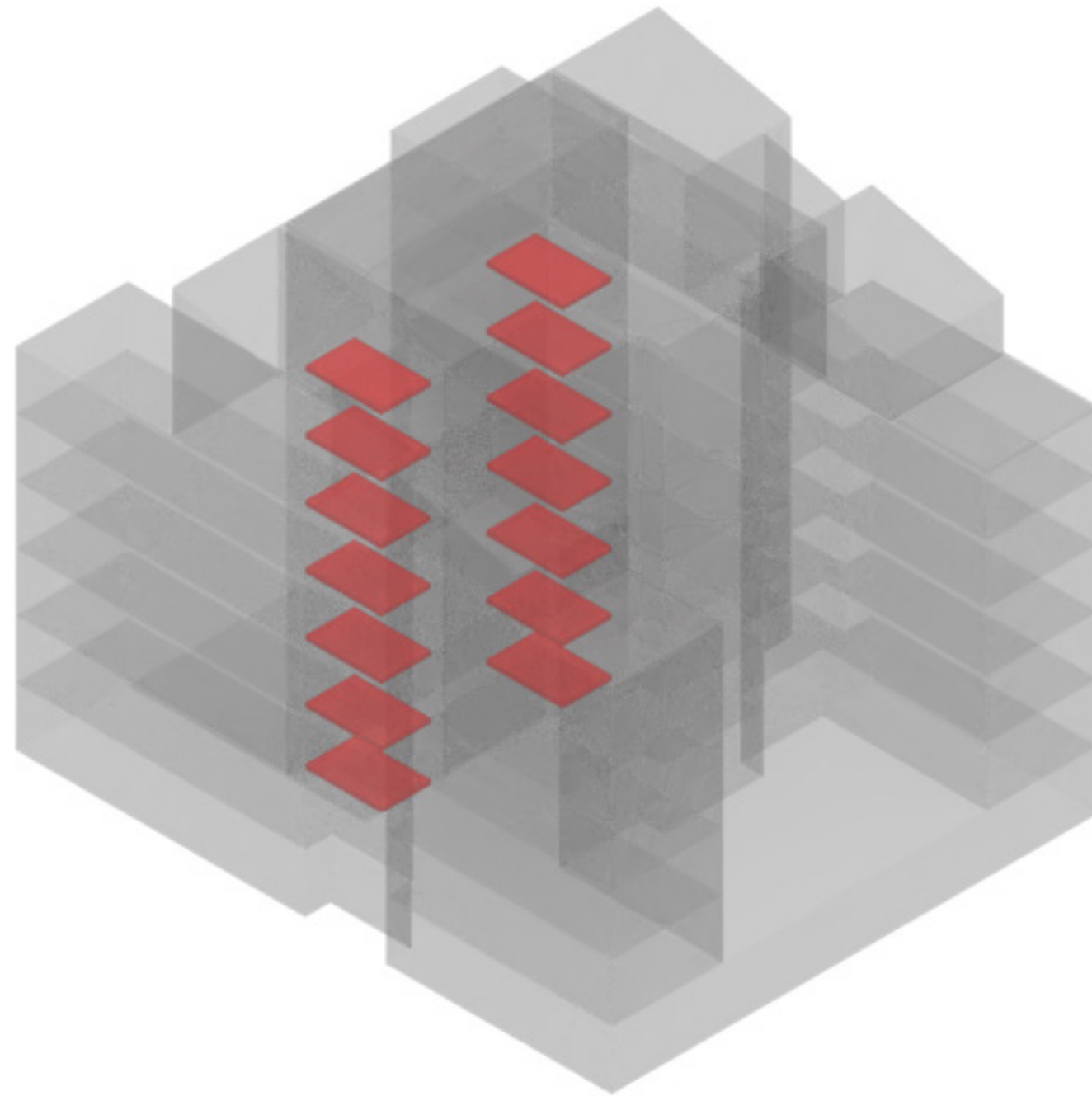

PROPOSED STRUCTURE: FLOOR PLATES

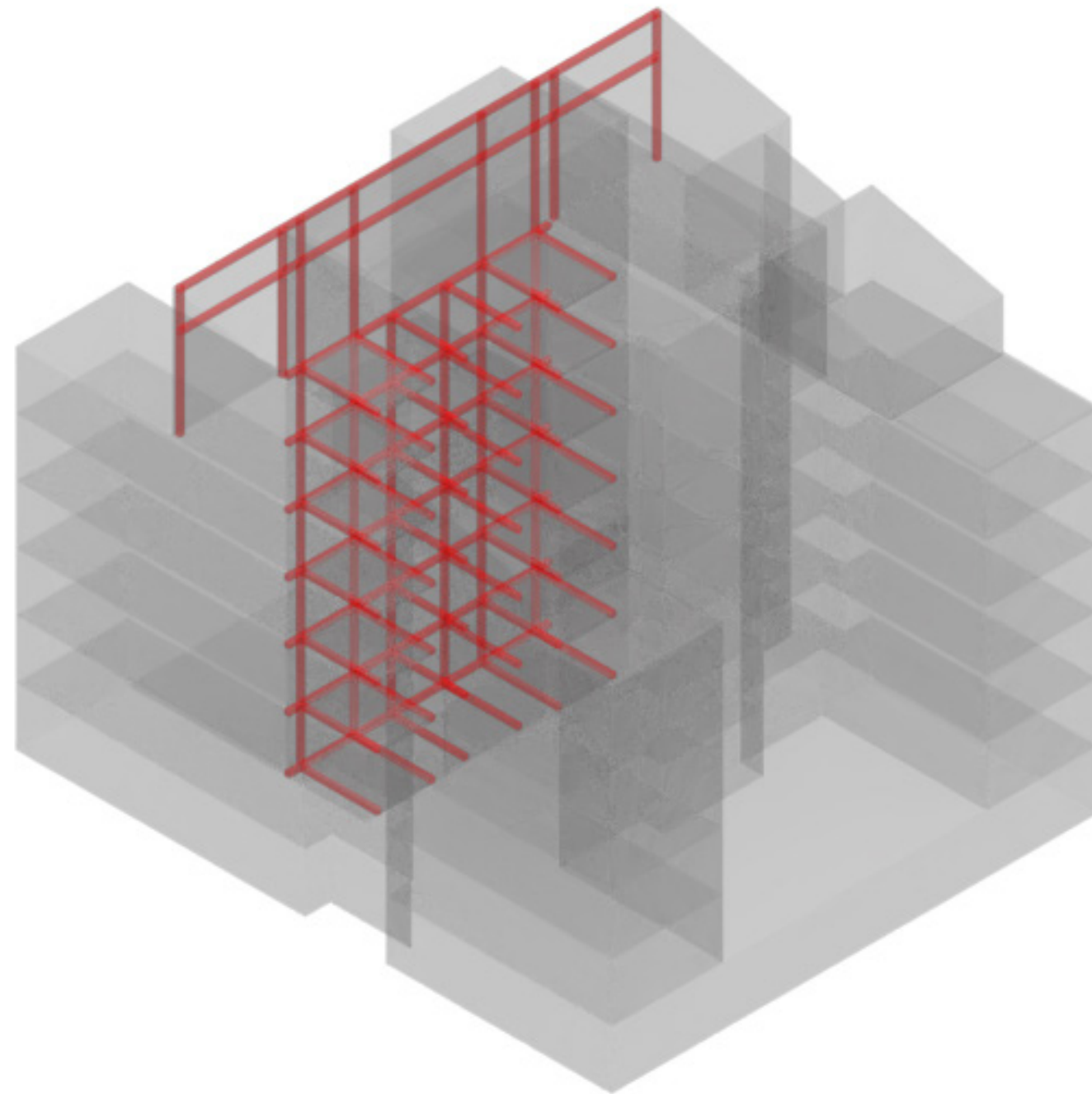

PROPOSED STRUCTURE: ADDITION

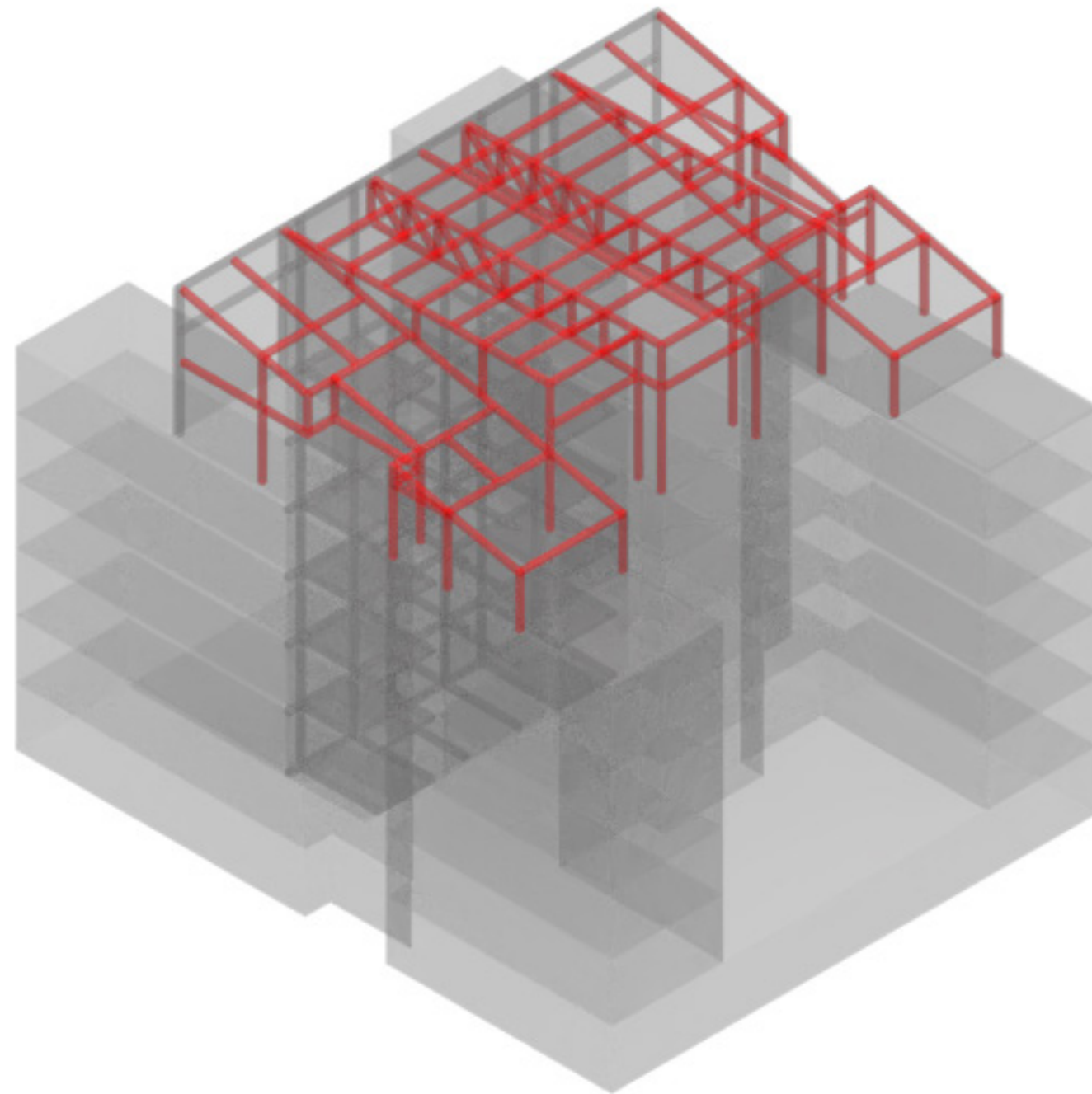

PROPOSED STRUCTURE: ROOF SYSTEM

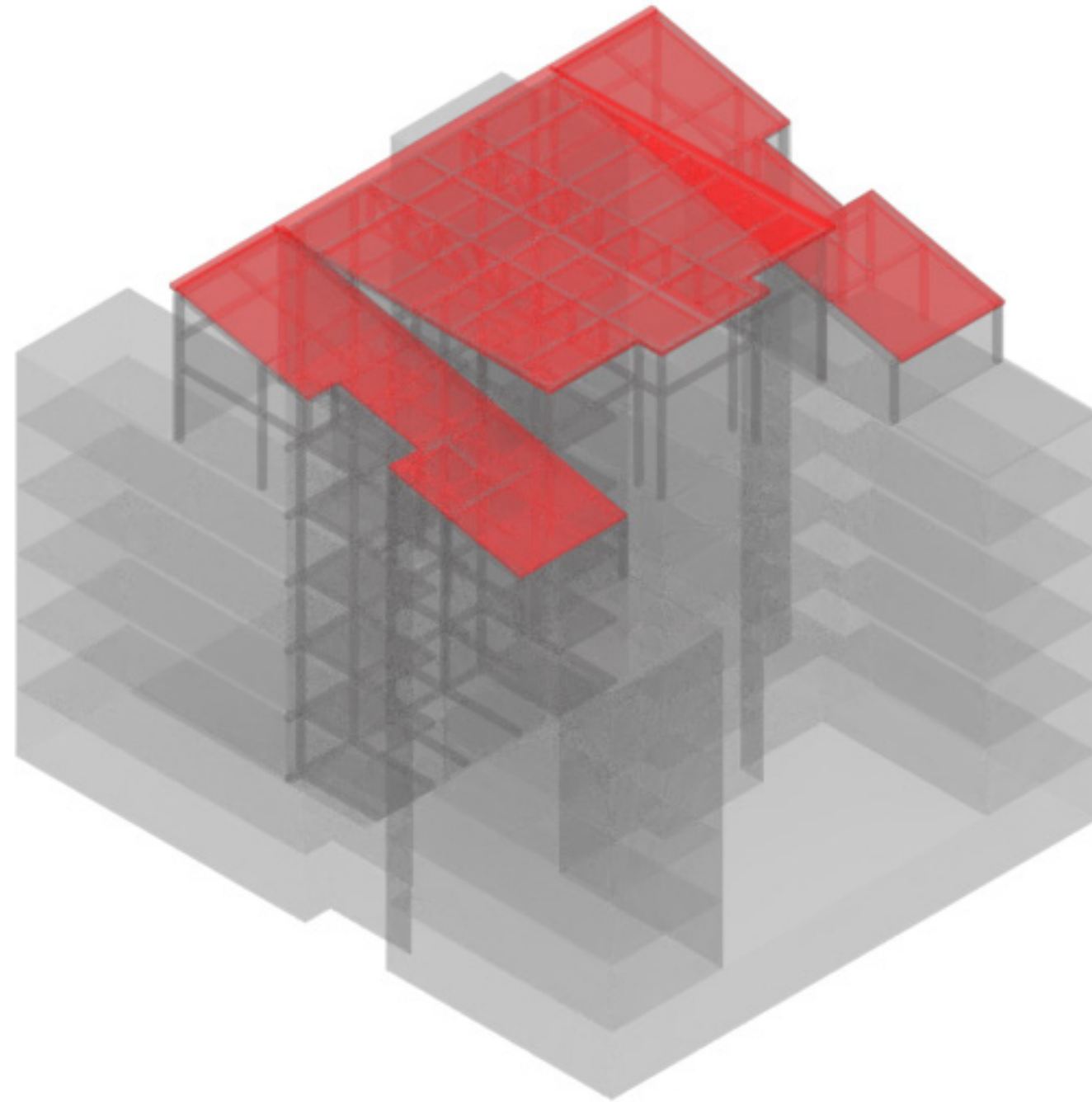

PROPOSED STRUCTURE: ROOF

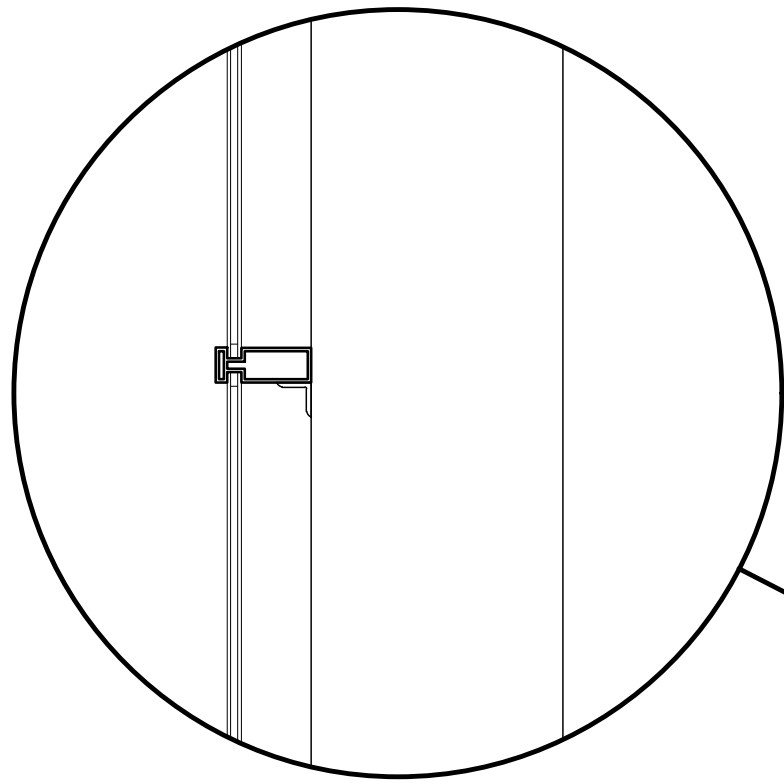

GLAZING TO COLUMN CONNECTION

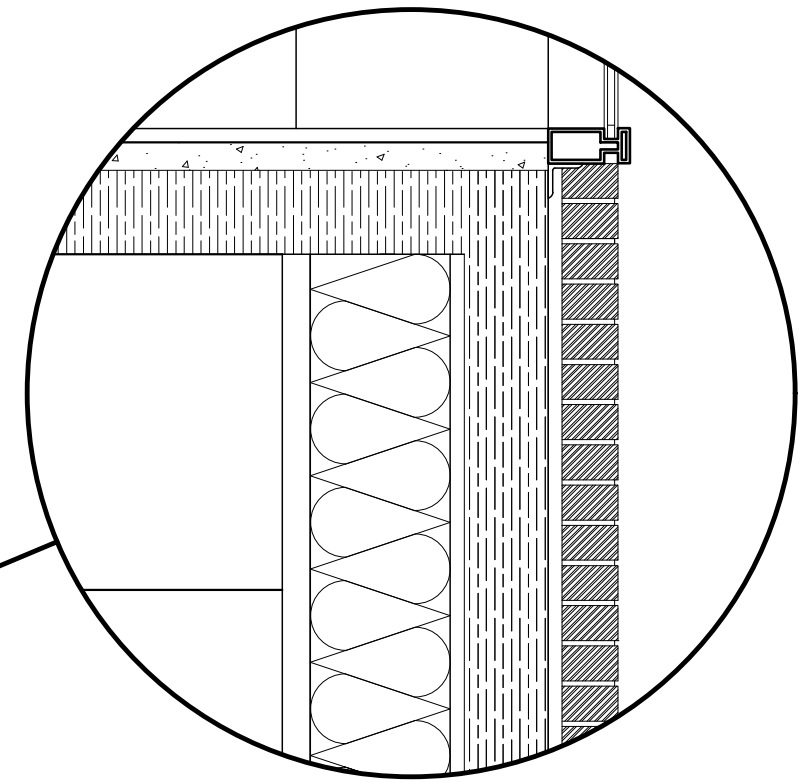

WALL DETAIL

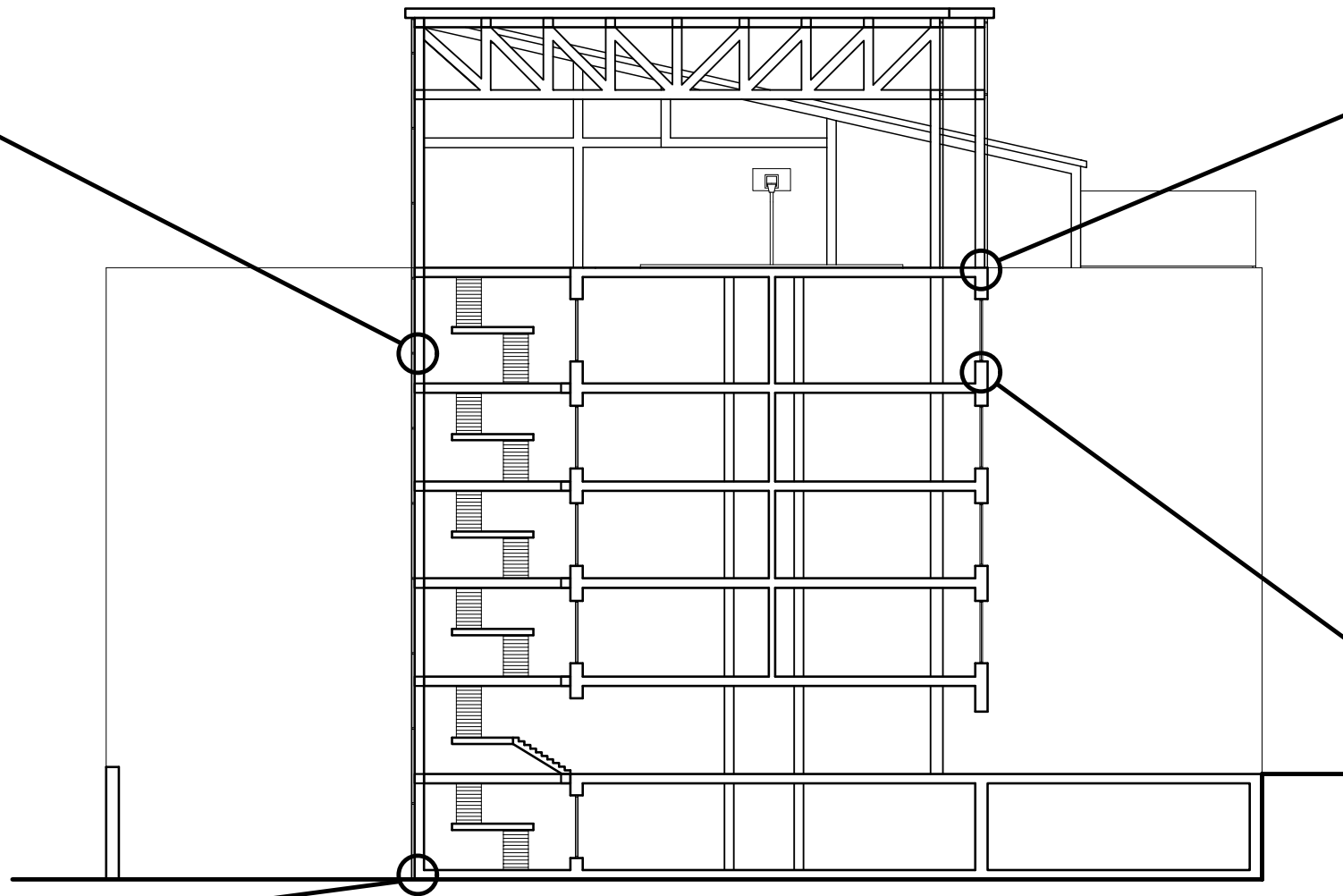

STRUCTURAL DETAILS

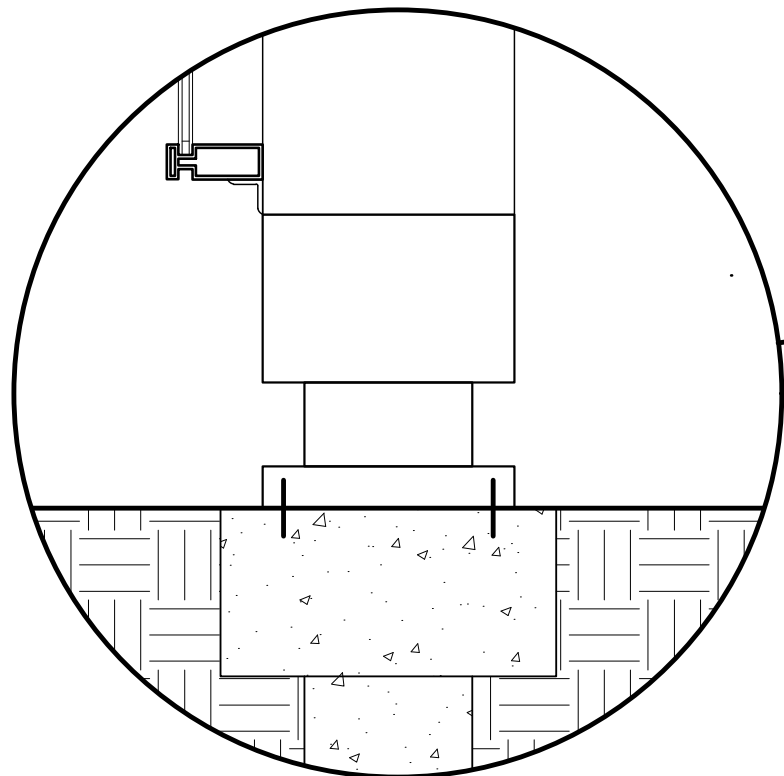

COLUMN TO GROUND CONNECTION

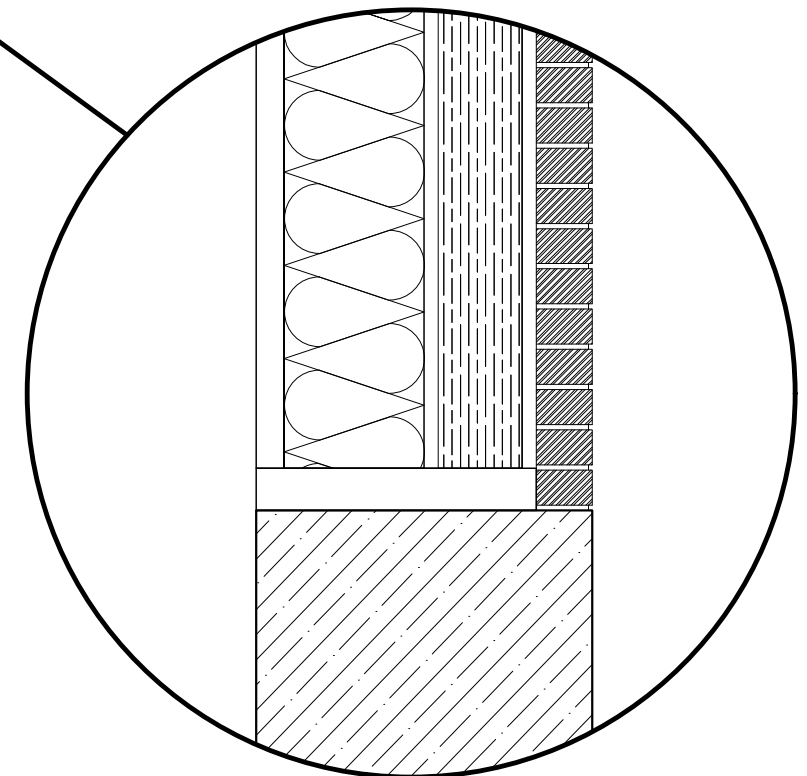

COLUMN & EXTERIOR CLADDING TO EXISTING MASONRY WALL







