



DIAGRAMS OF

THE

CERTAINTY

Rourke Brakeville

GSAPP

DIAGRAMS OF
[UN] *CERTAINTY*

Rourke Brakeville
GSAPP

How can you read without word?

01 *Spectra*

02 *Depth of Decay*

03 *Defeated Floods*

04 *Ascending Cliffs*

05 *Fallen Dust*

CONTENTS

01 SPECTRA

OUTSIDE IN

LOCATION:	NEW YORK, NY
TYPE:	INSTALLATION
DATE:	SPRING, 2022
INSTRUCTOR:	GALIA SOLOMONOFF LAURIE HAWKINSON



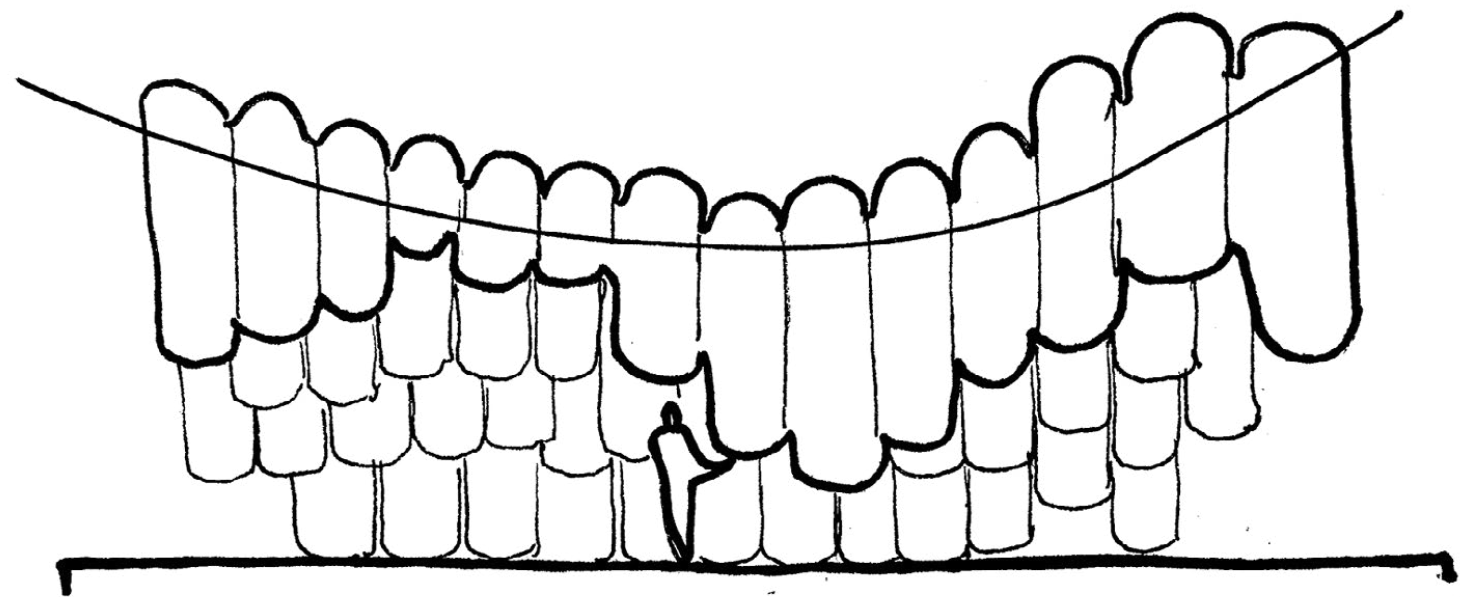
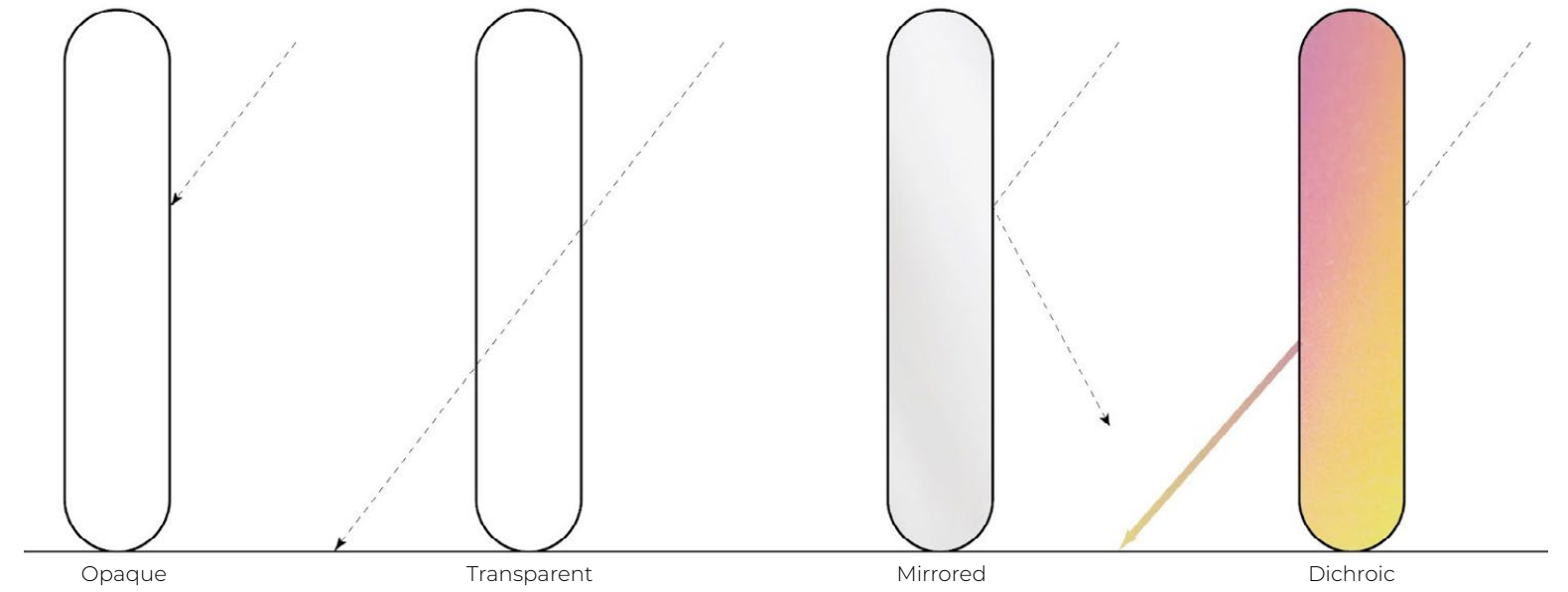

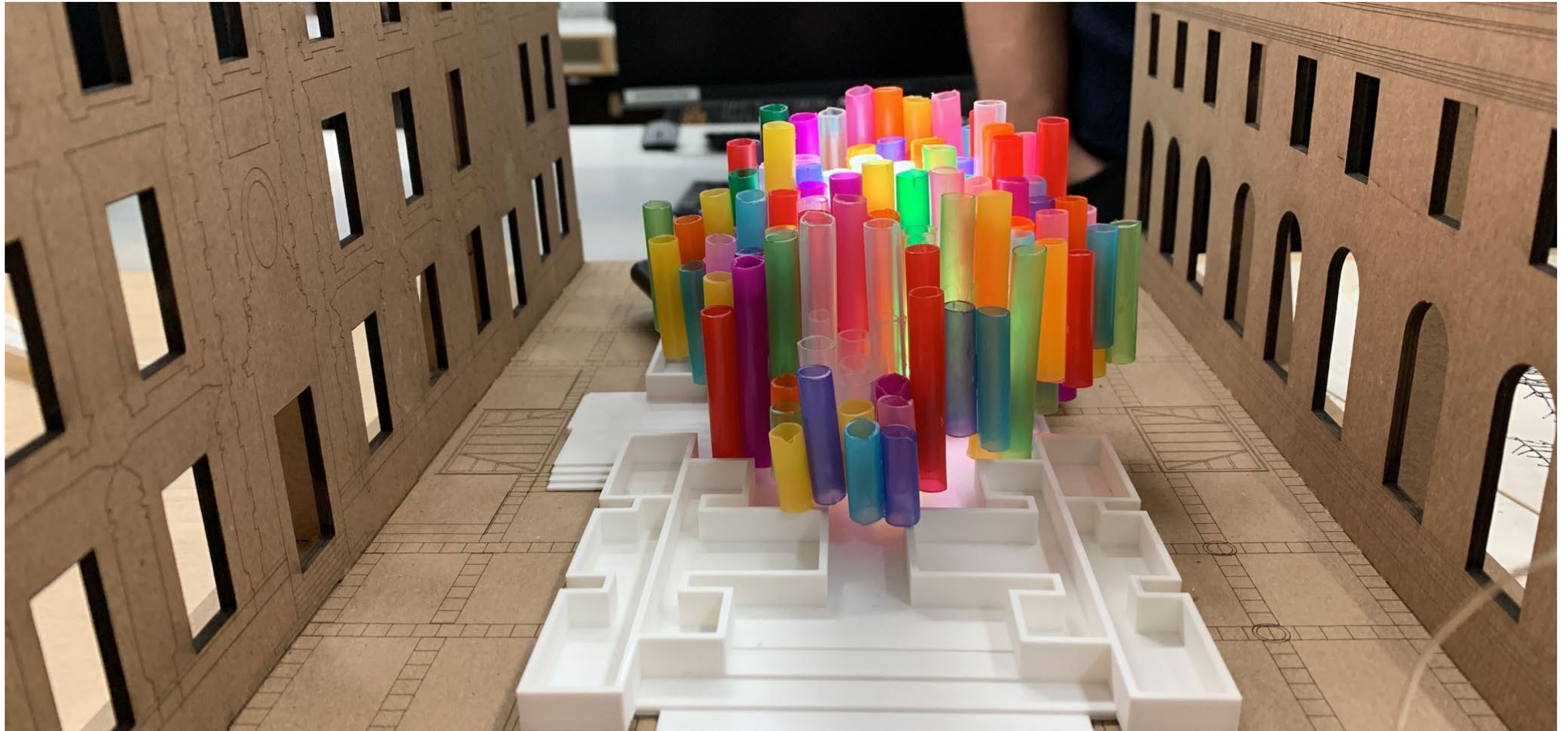





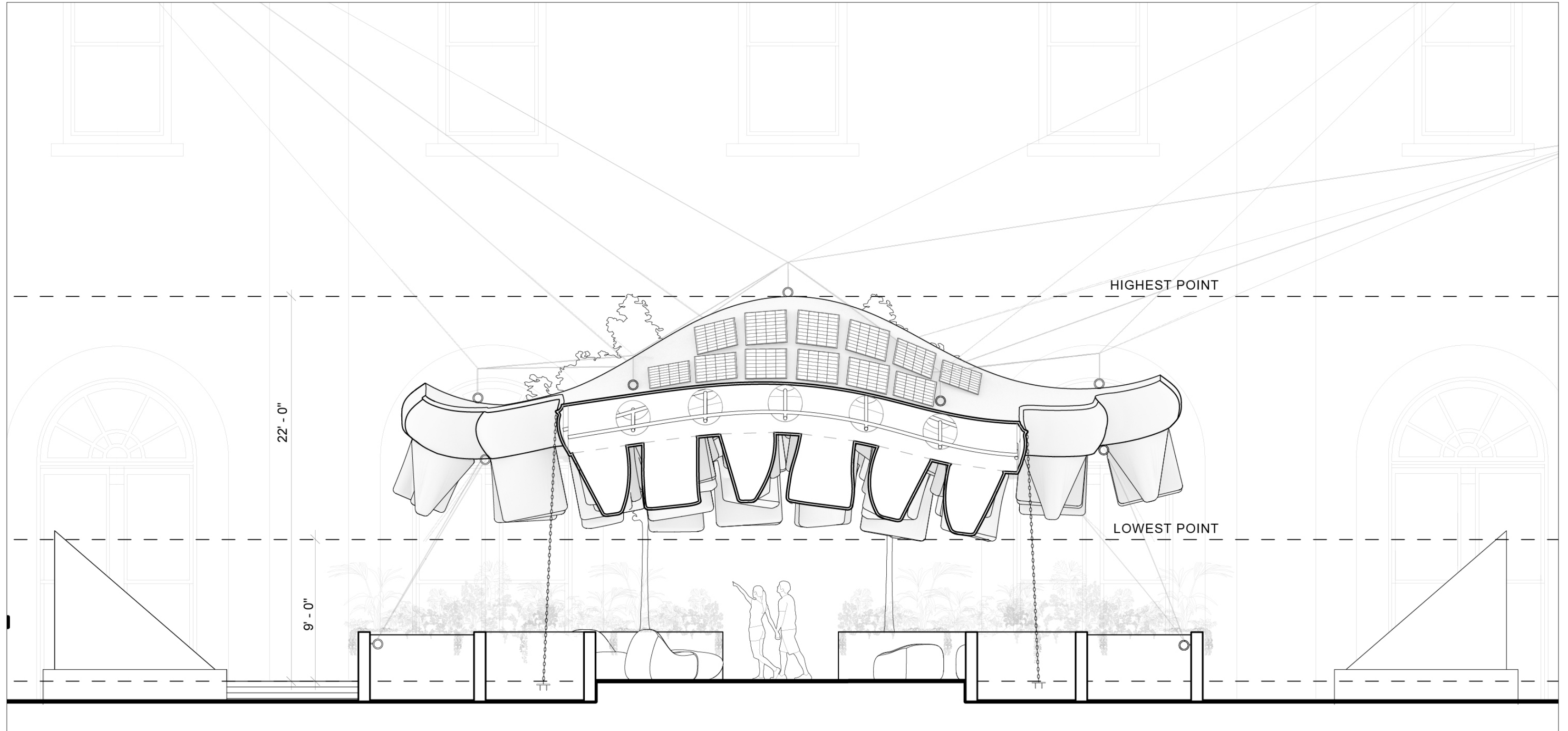

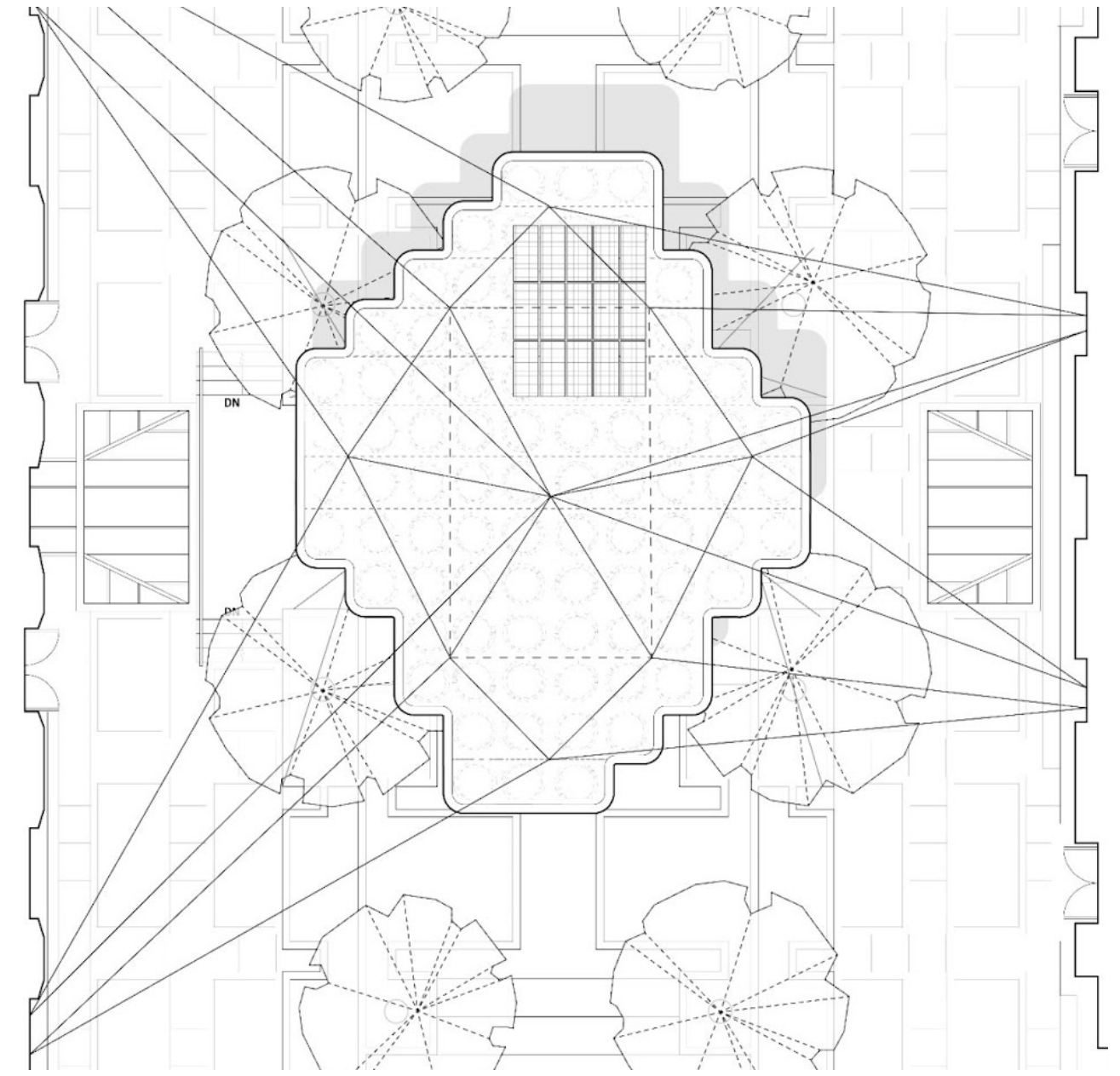
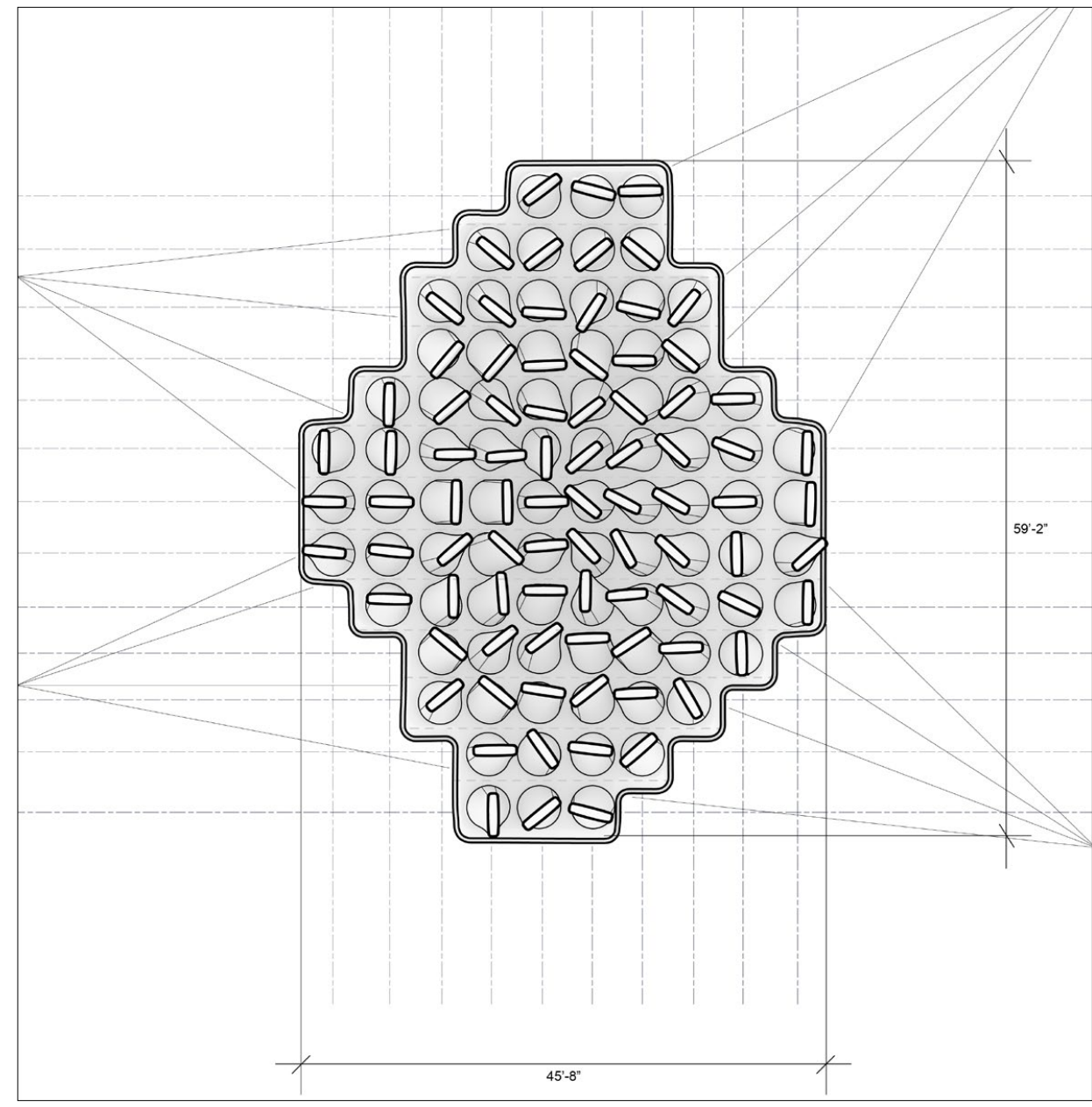

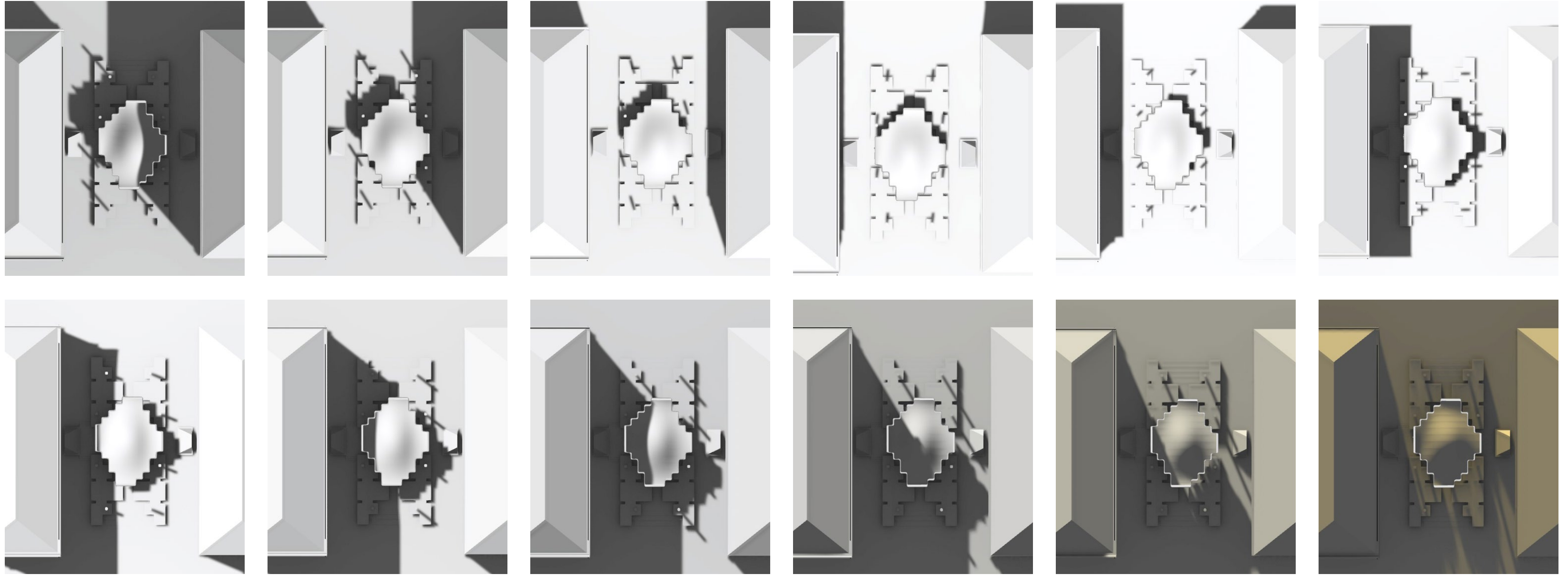

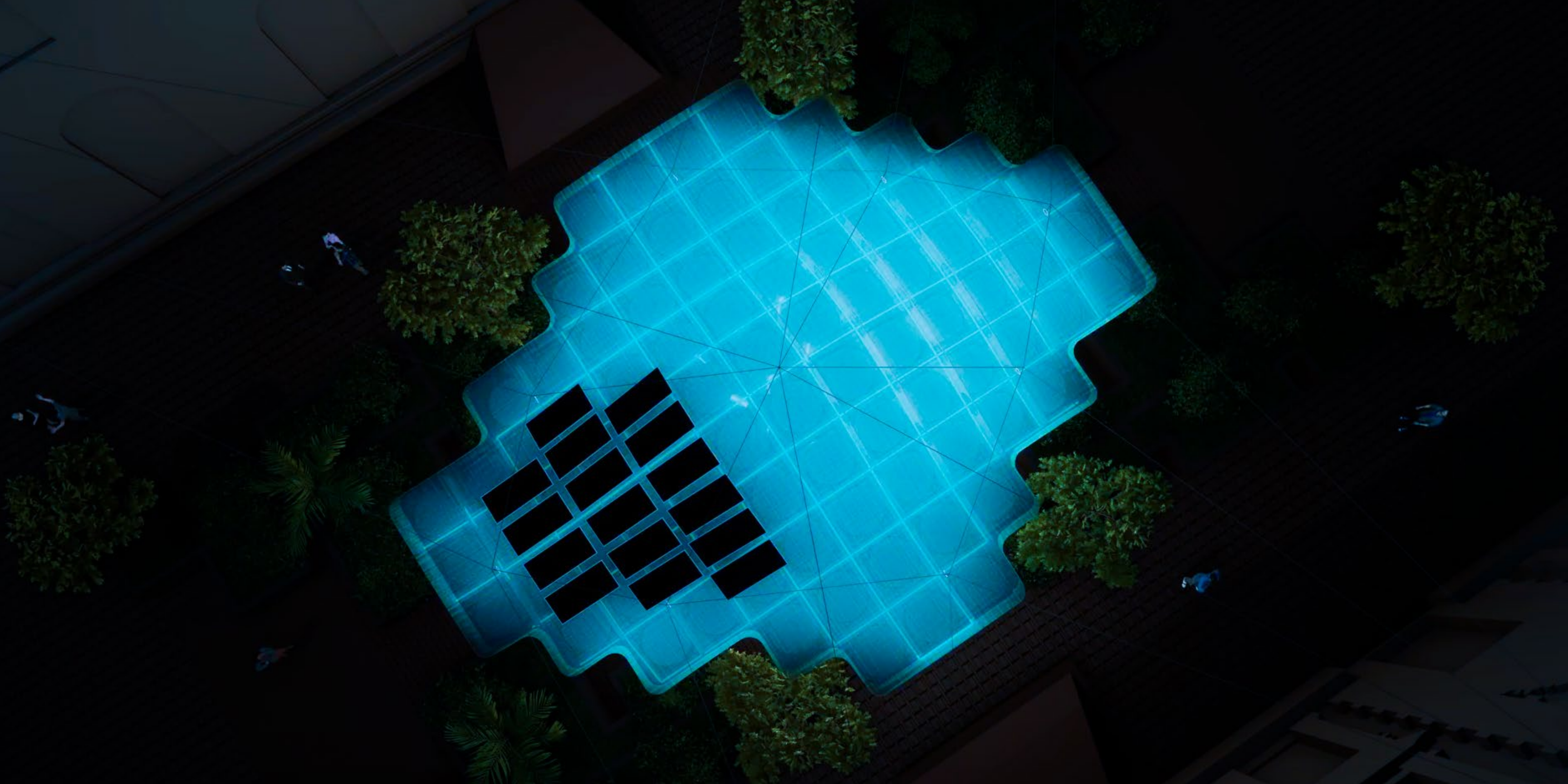

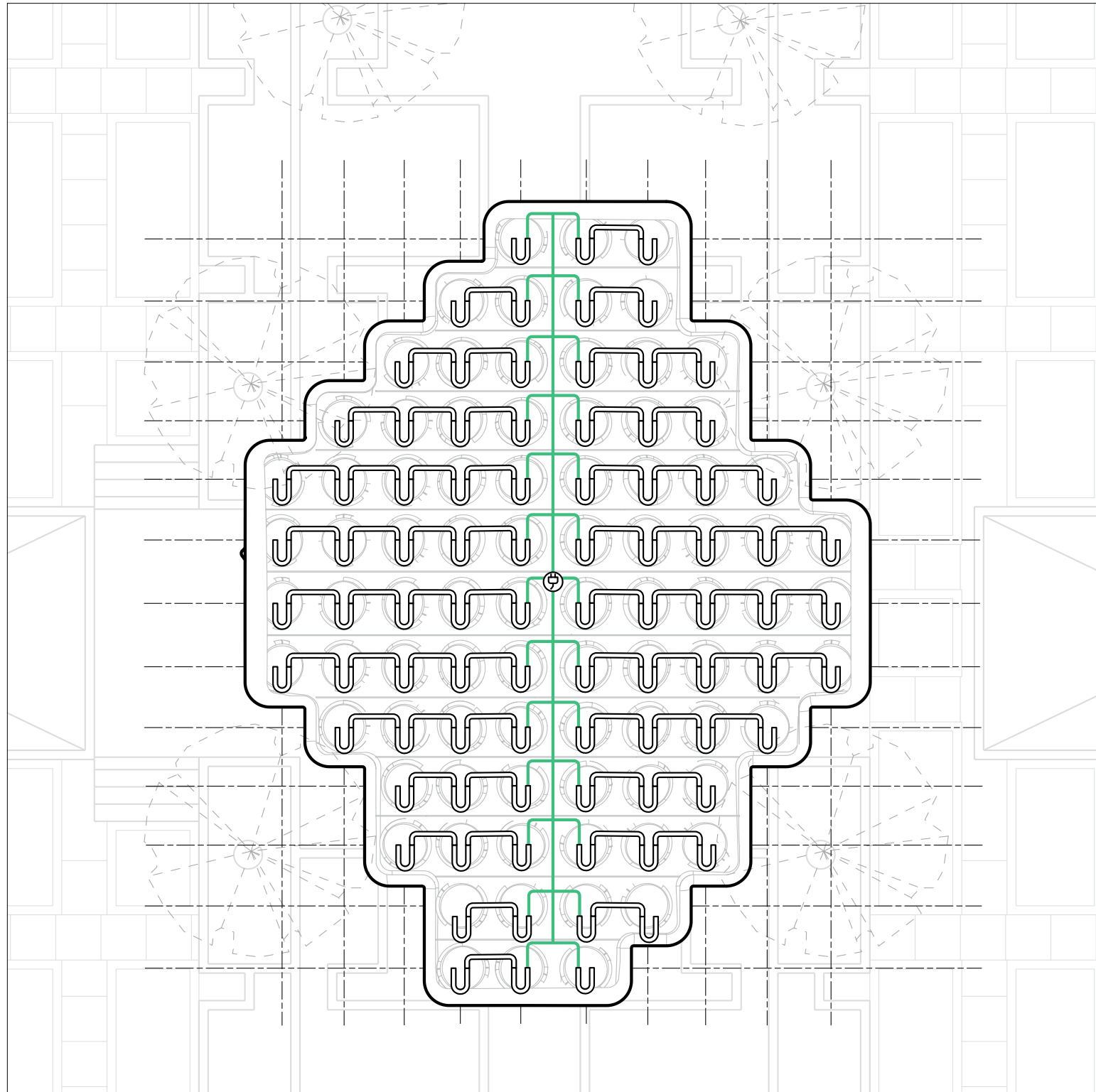

1 Solar Panels

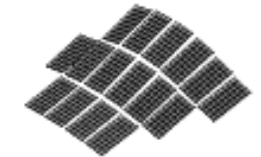

2 Top Membrane

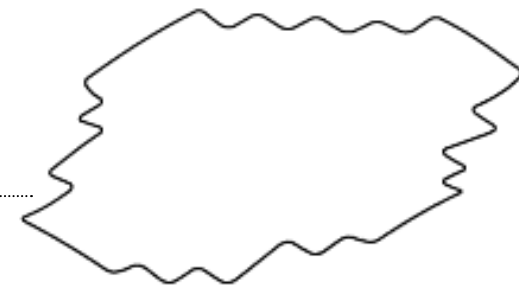

3 Interior Ribbing

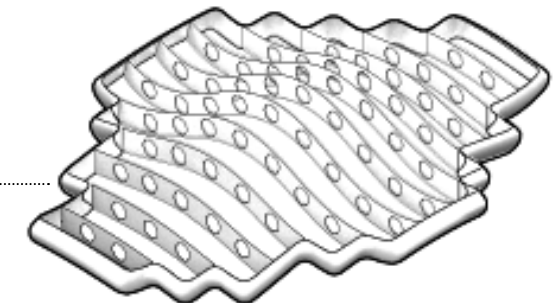

4 LED Lighting System

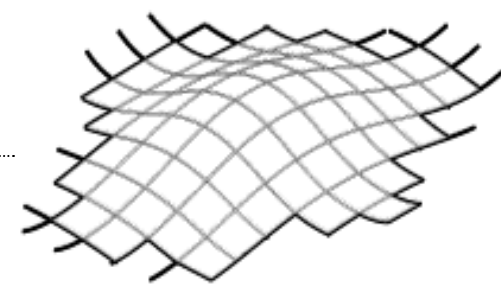

5 Bottom Membrane

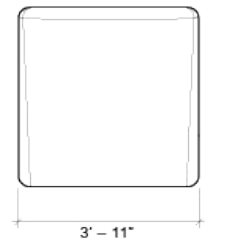
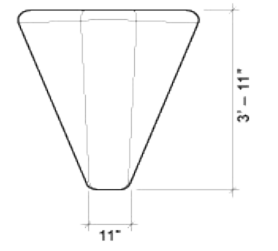
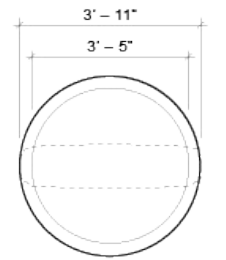
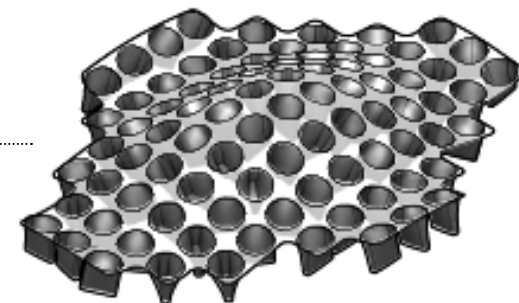

Exploded Axonometric and Module

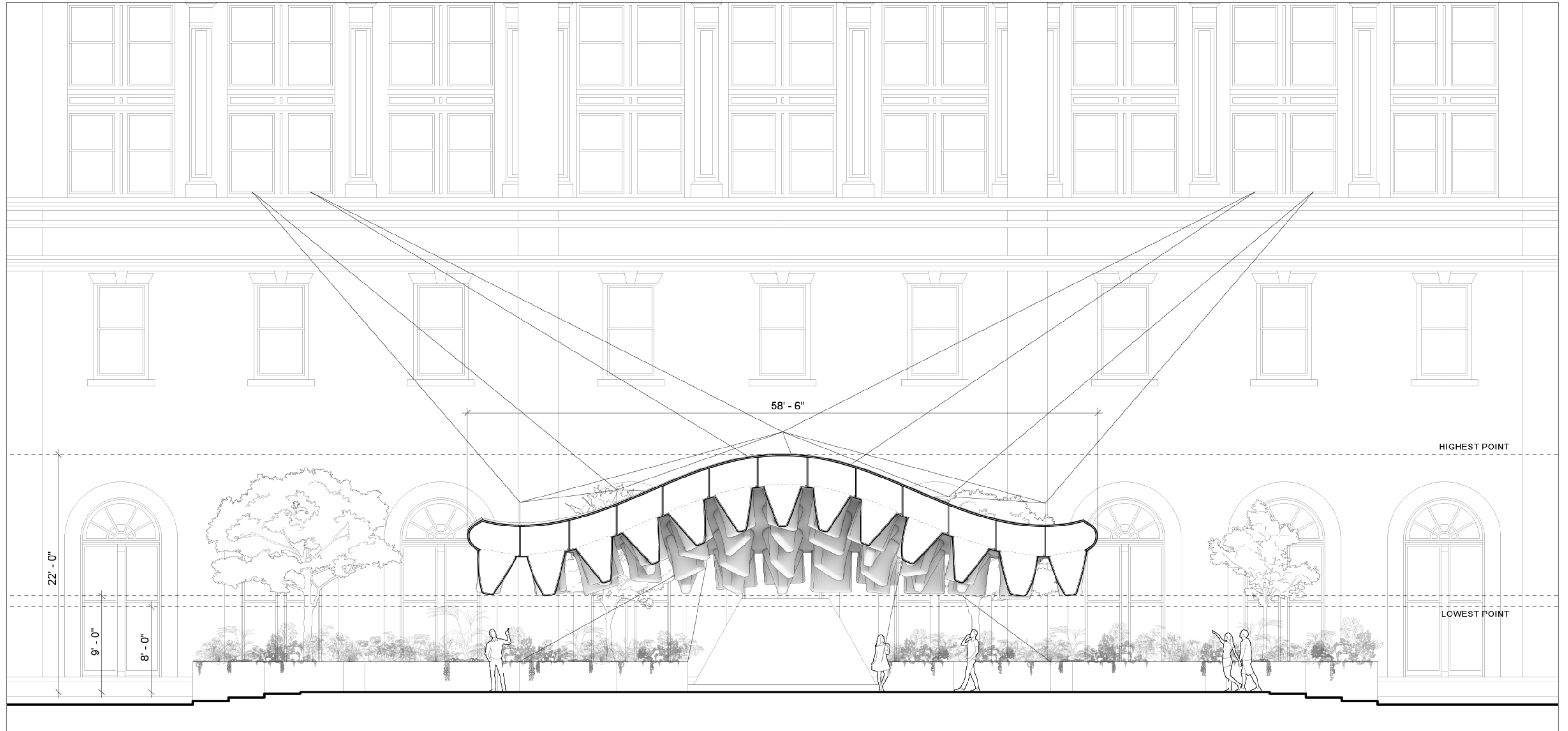

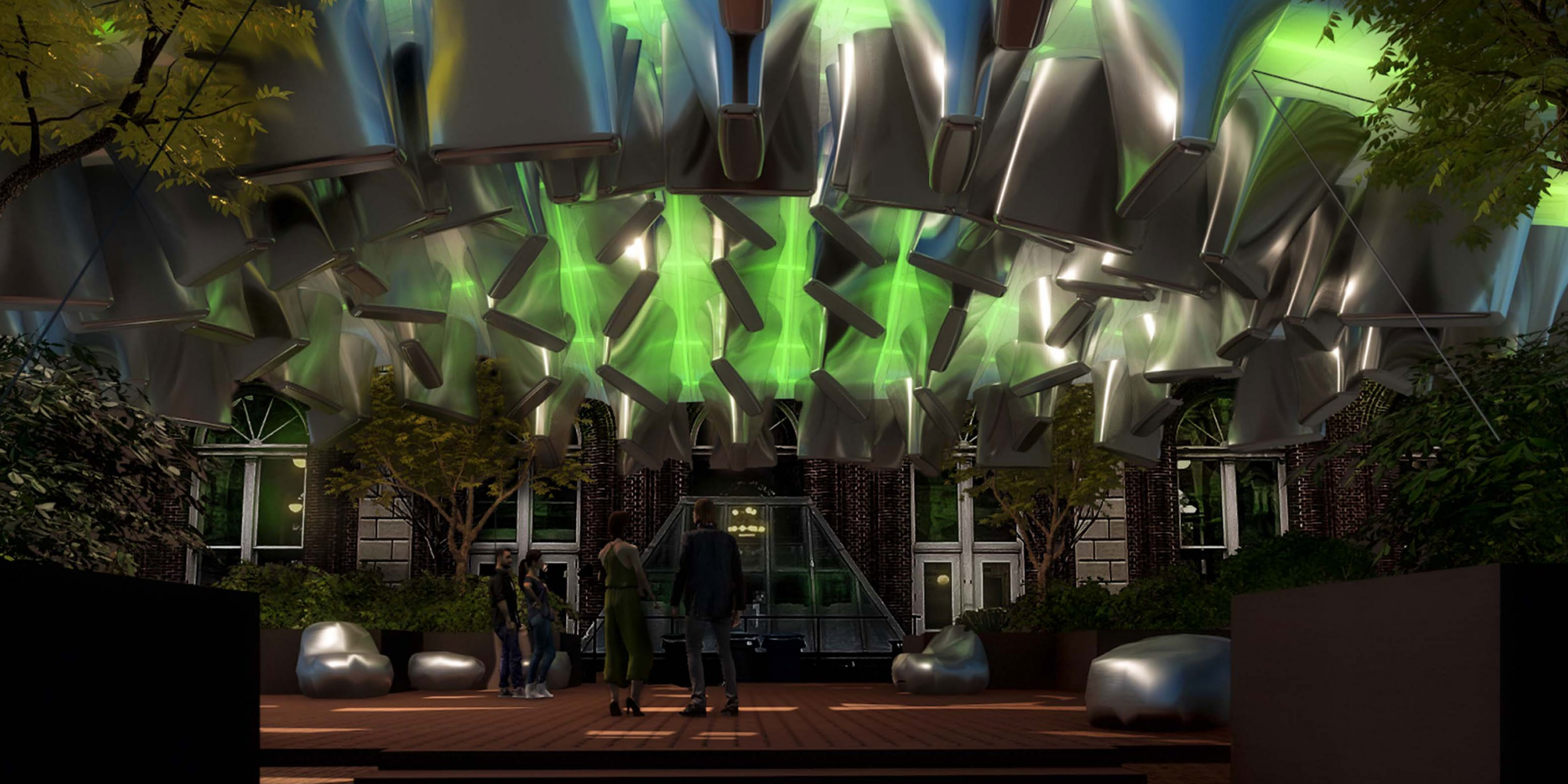

02 DEPTH OF DECAY

ENTANGLED STUDIO

LOCATION: NEW YORK, NY
TYPE: MEMORIAL
DATE: SUMMER, 2021
INSTRUCTOR: YUSSEF AGBO-OLA

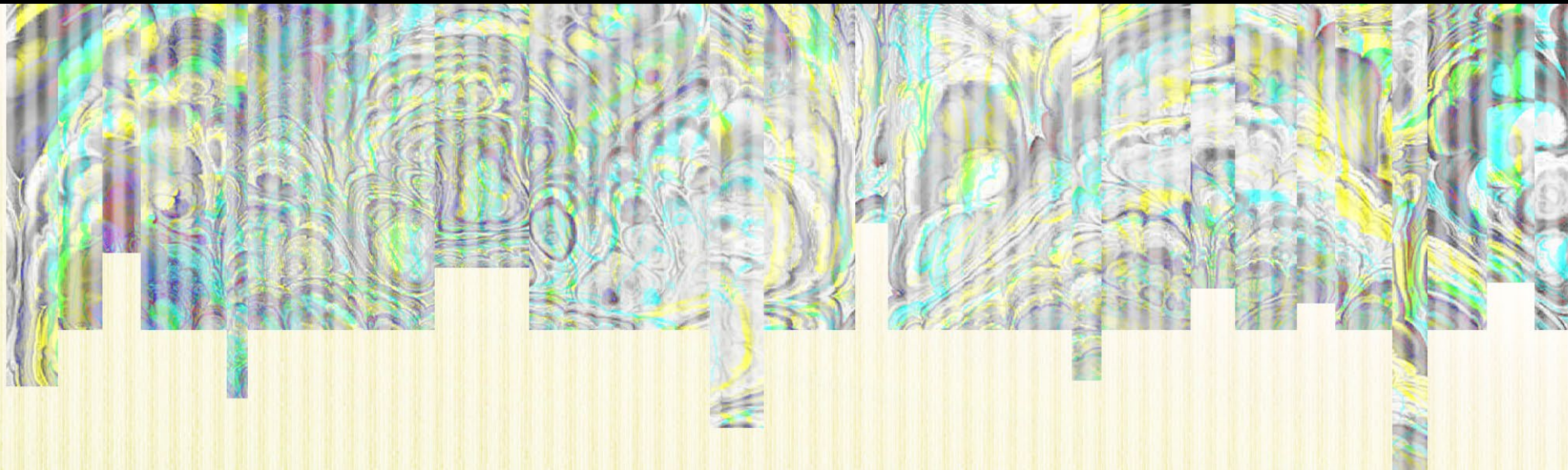







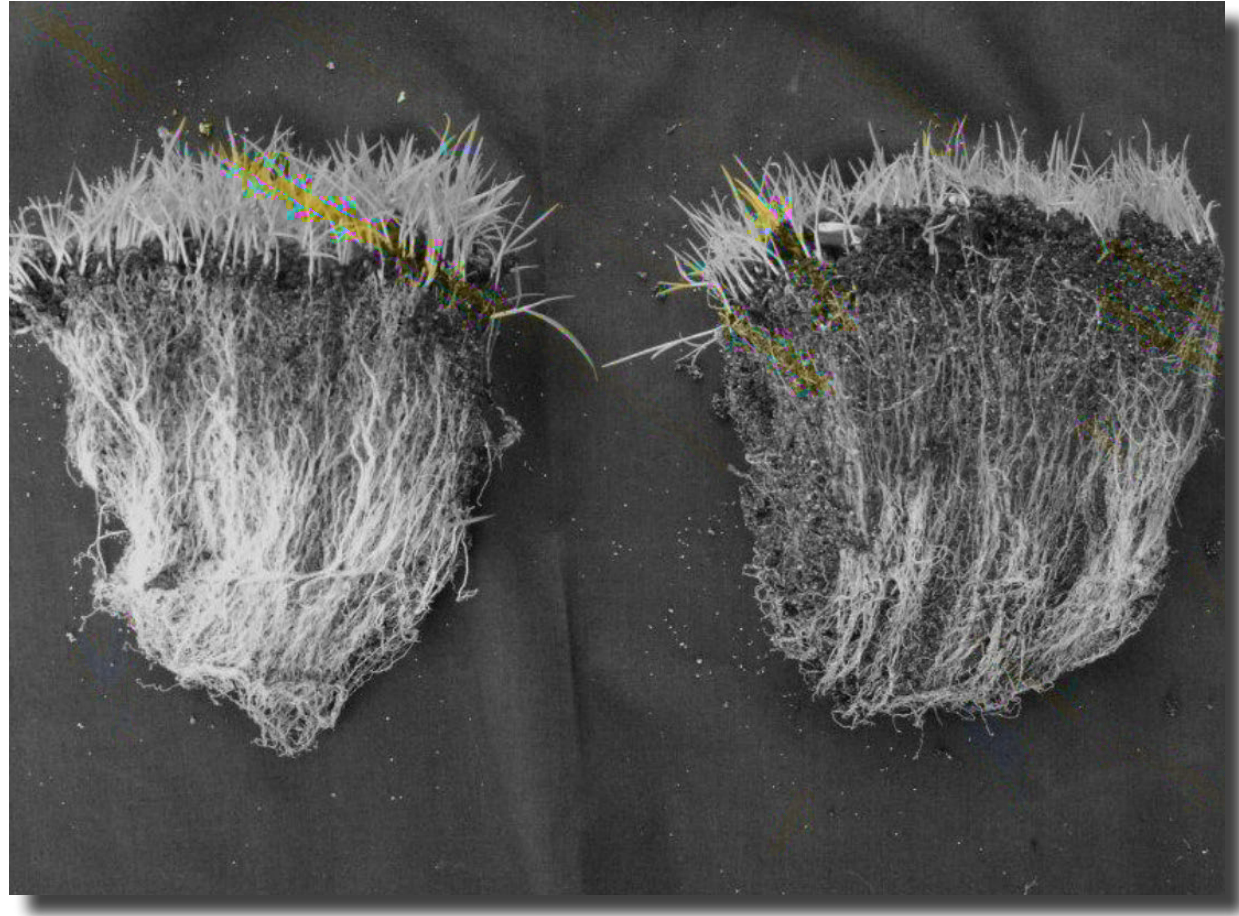

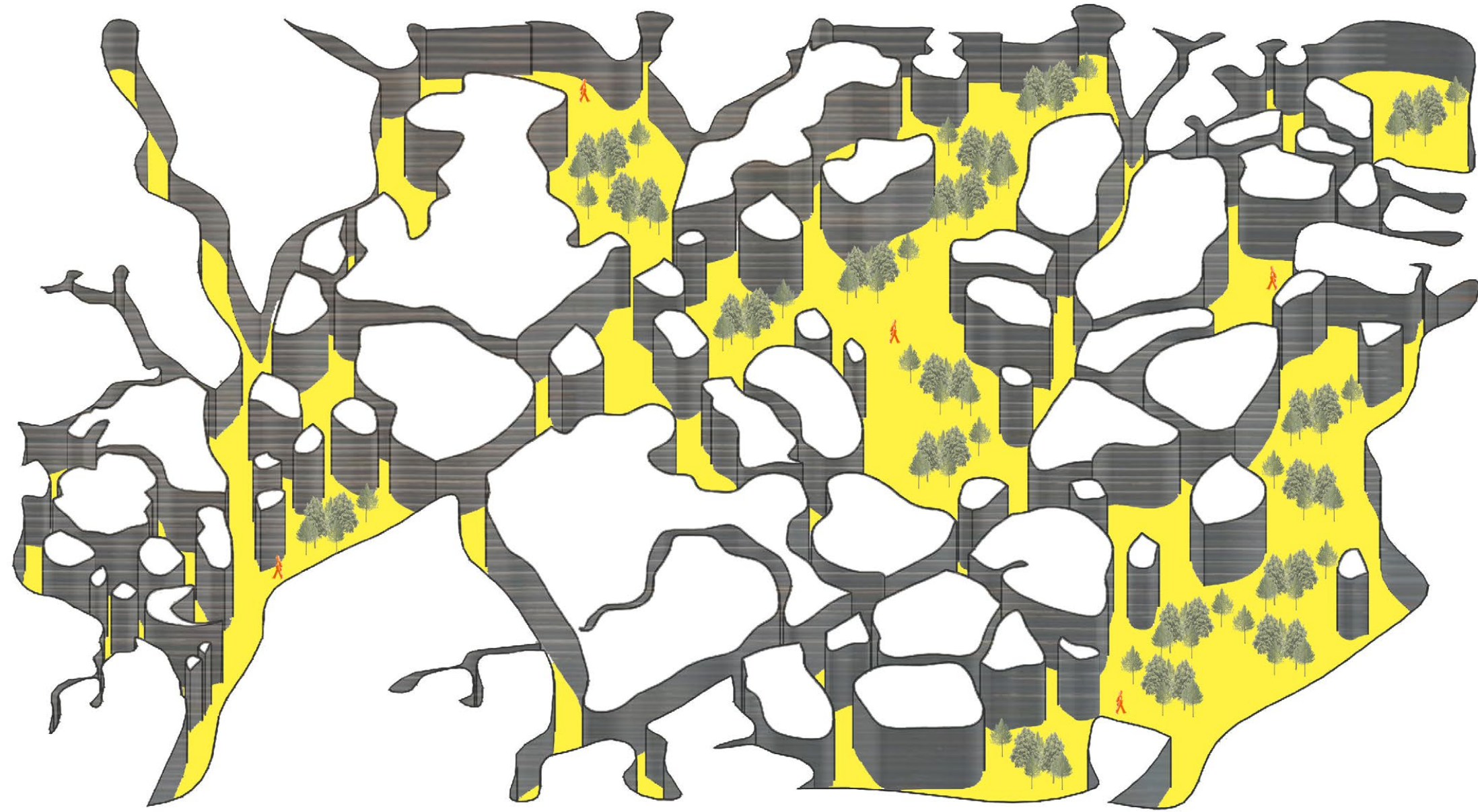

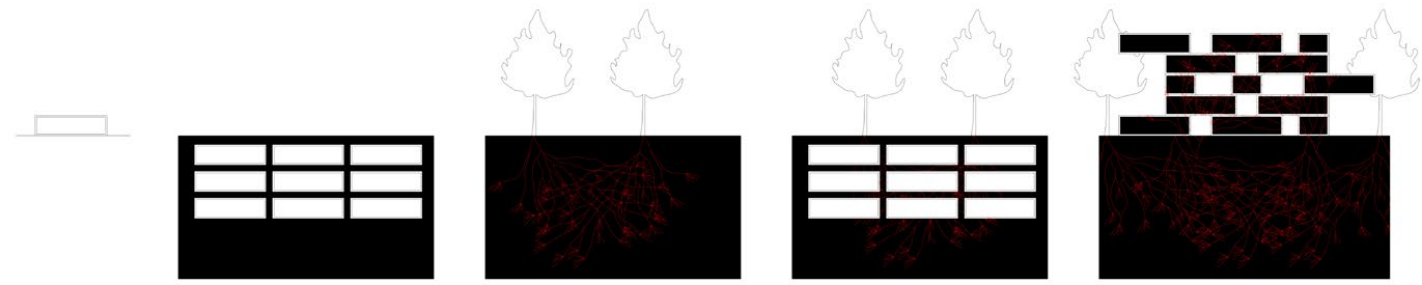

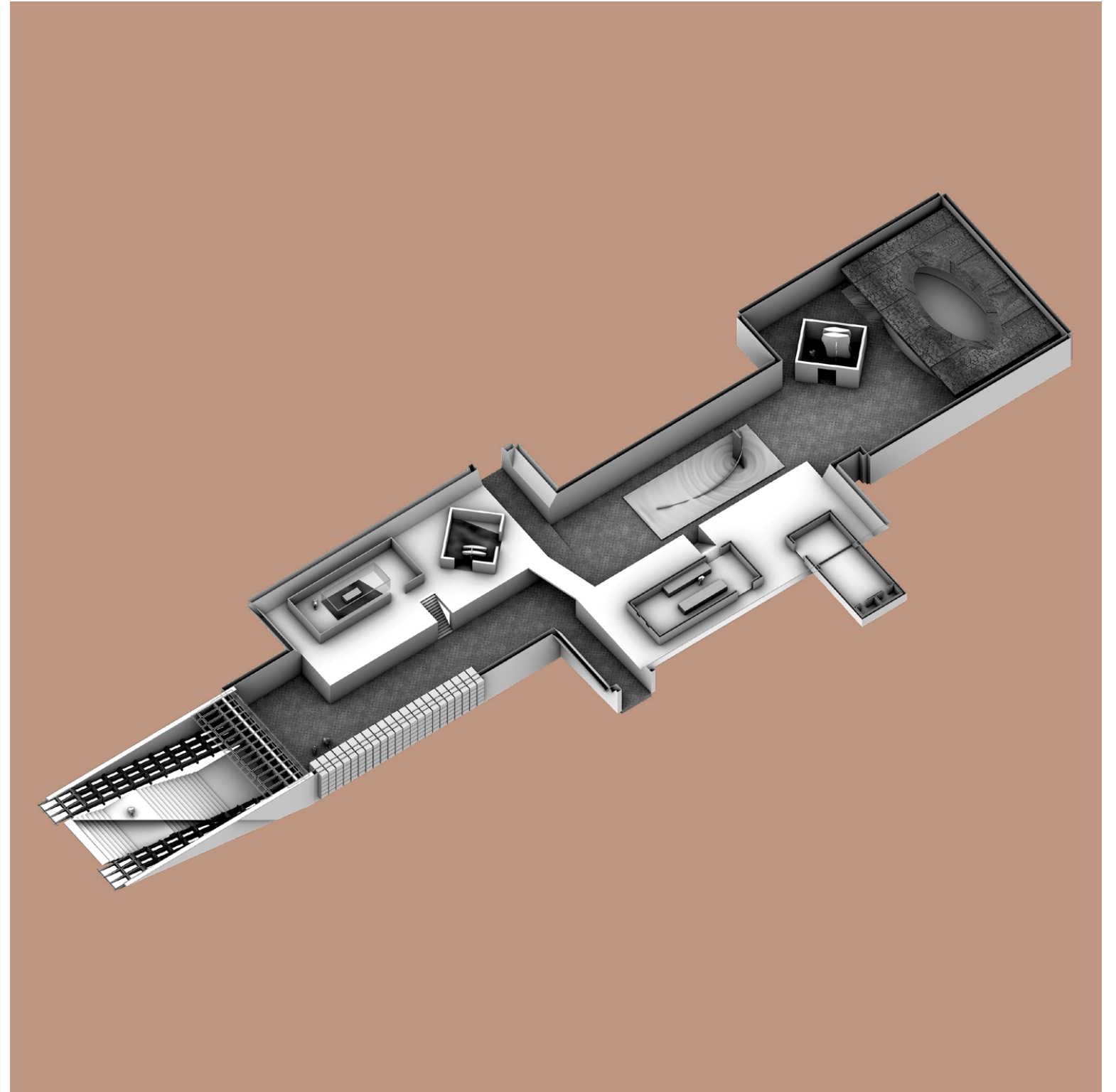
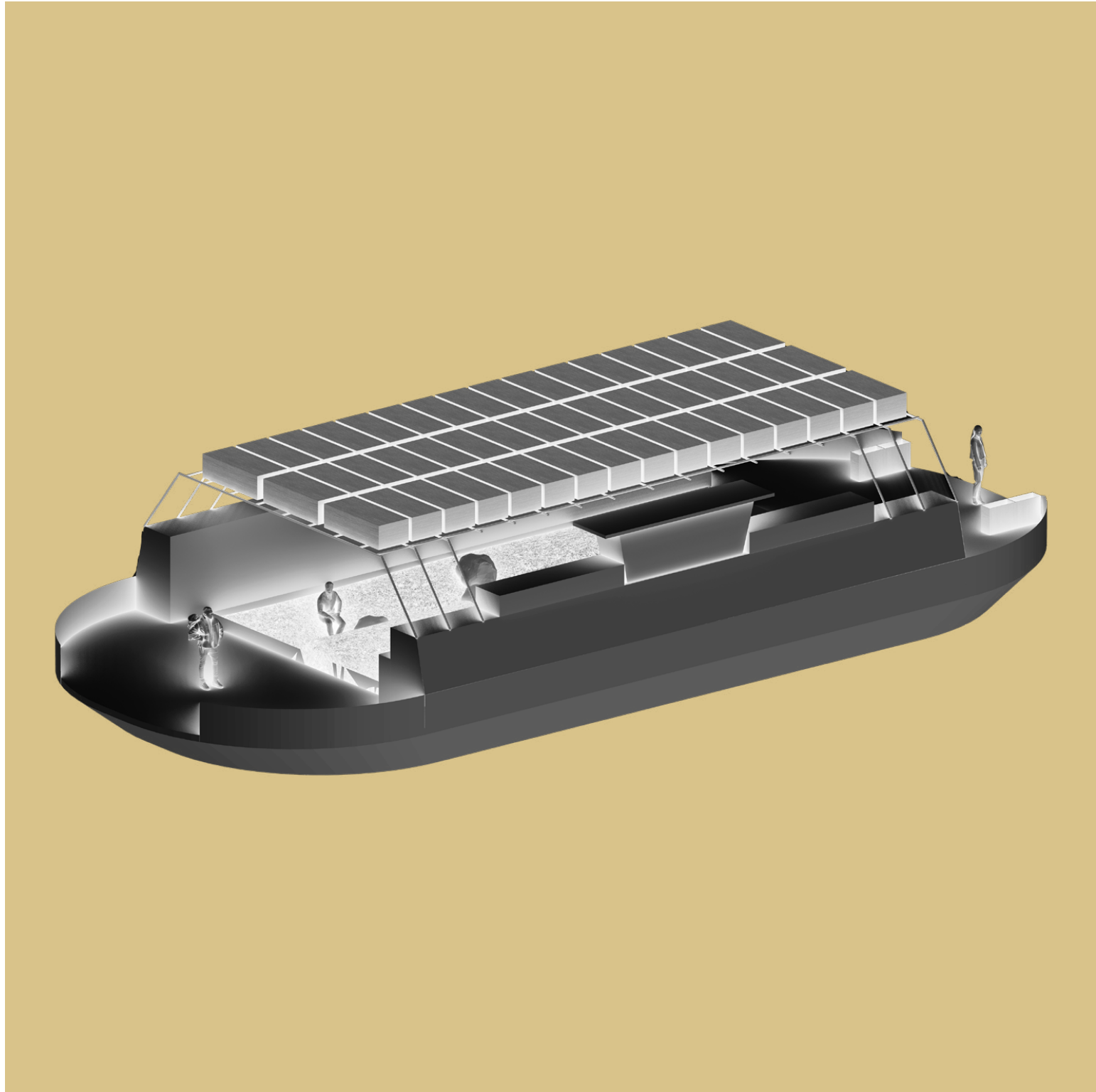

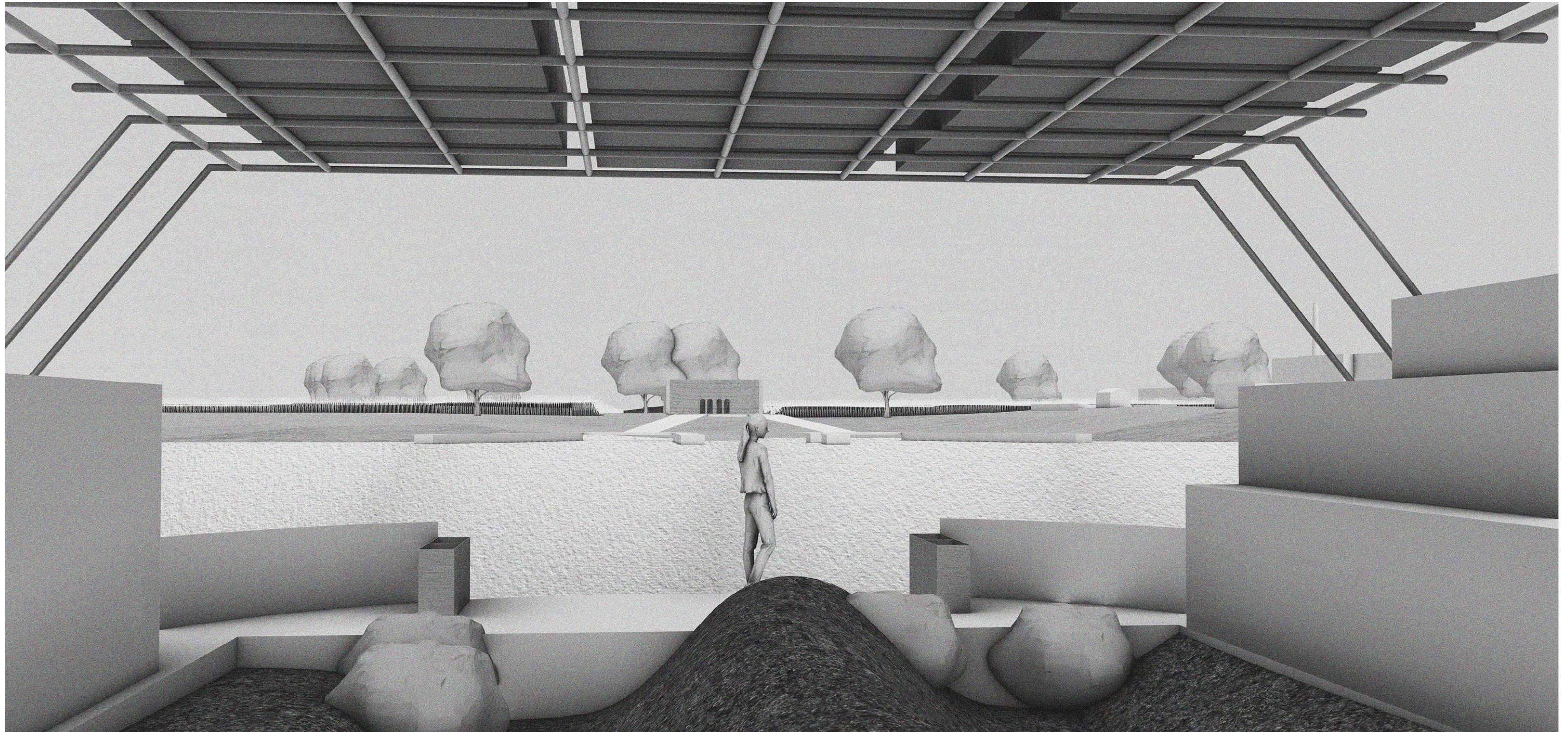

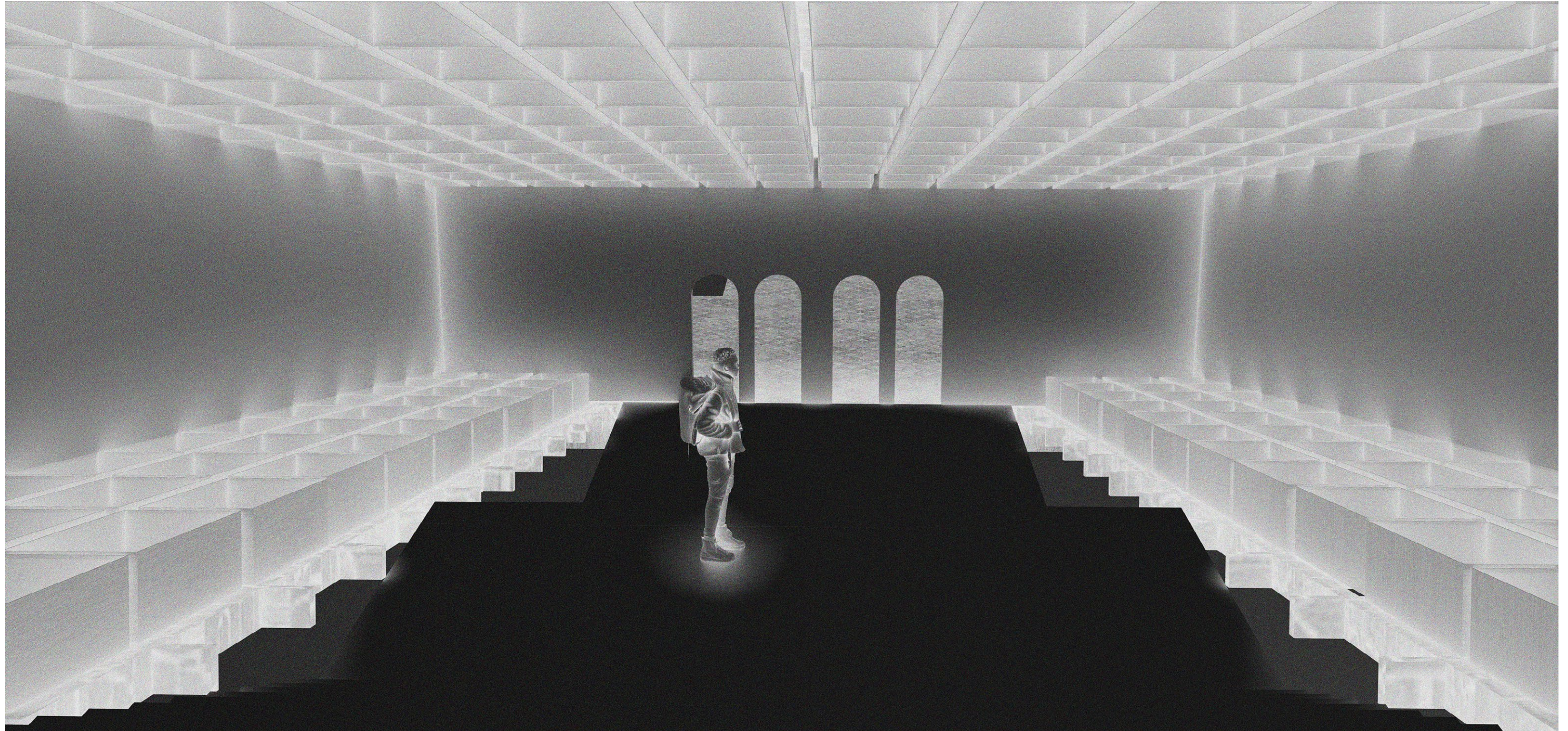

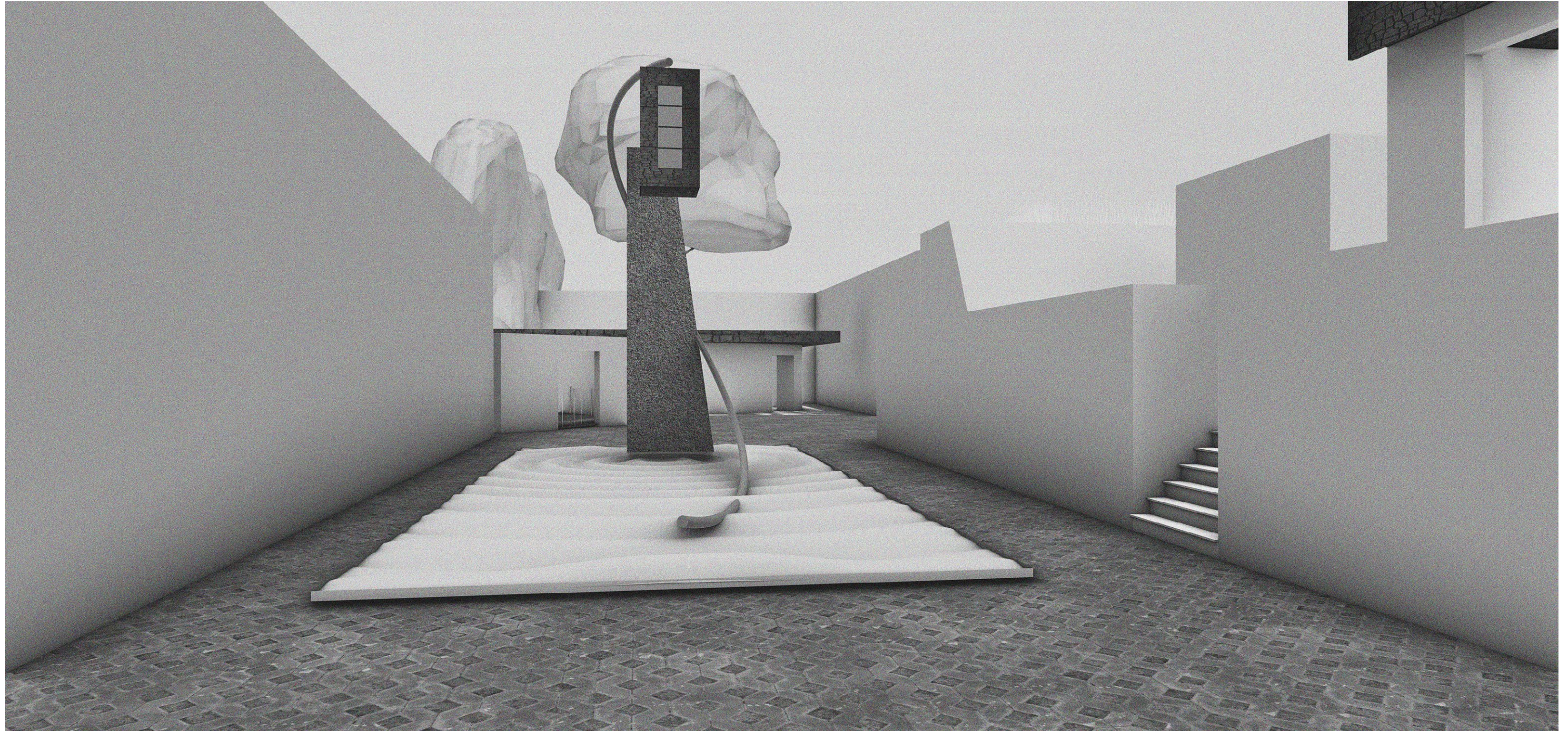

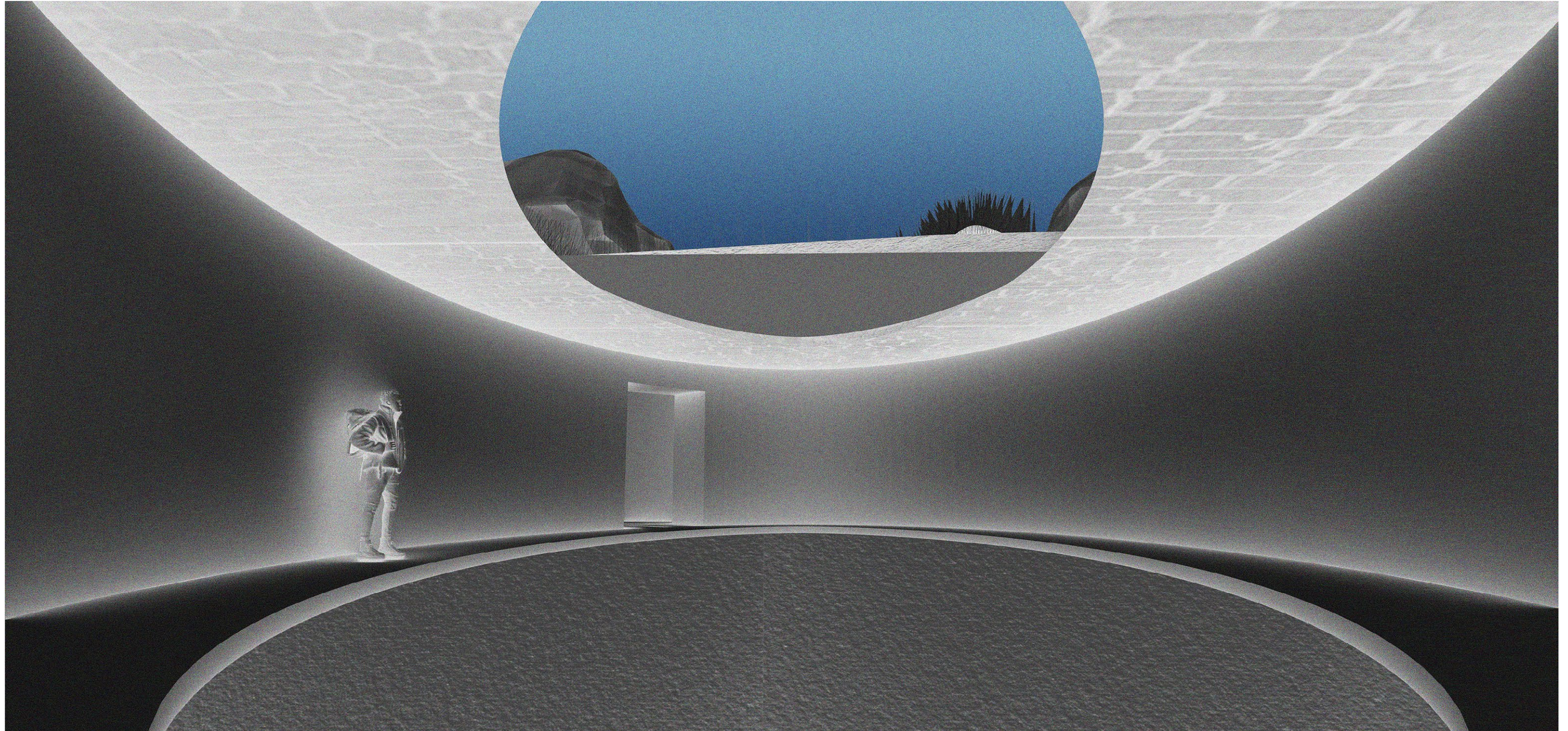

03 DEFEATED FLOOD

STUDIO V

LOCATION: NEW YORK, NY
TYPE: BATHHOUSE
DATE: FALL, 2021
INSTRUCTOR: BERNARD TSCHUMI

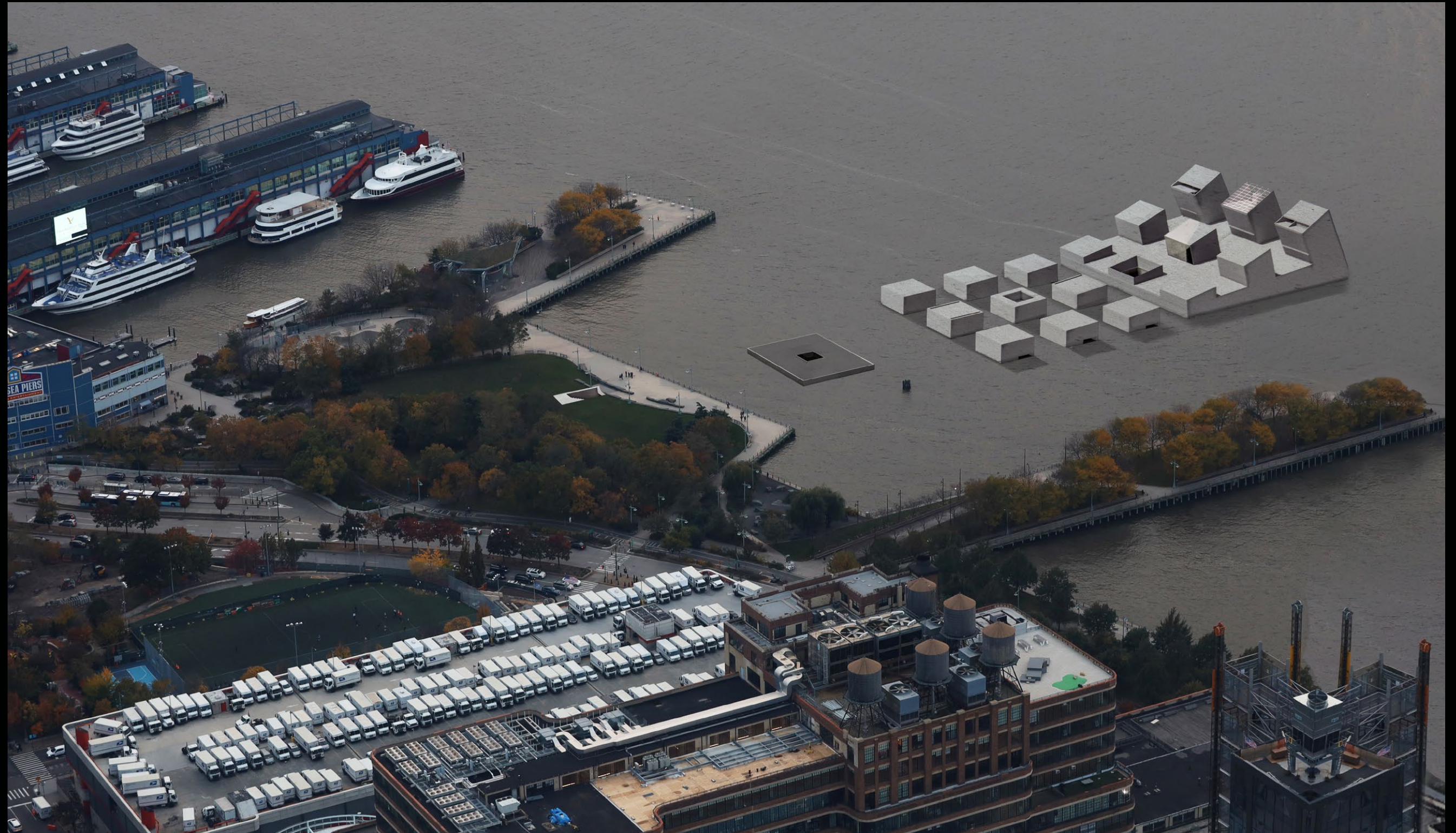



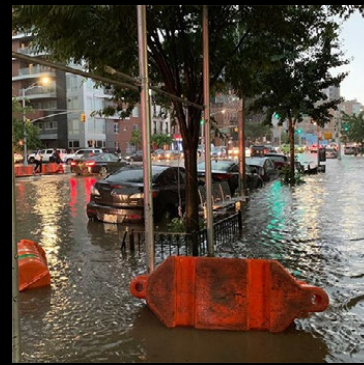
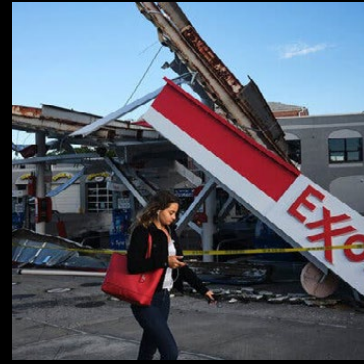

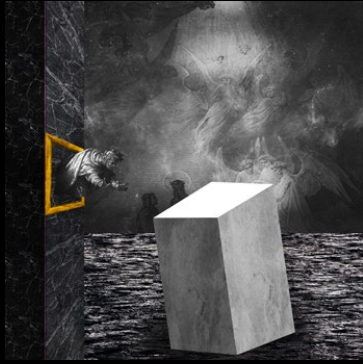
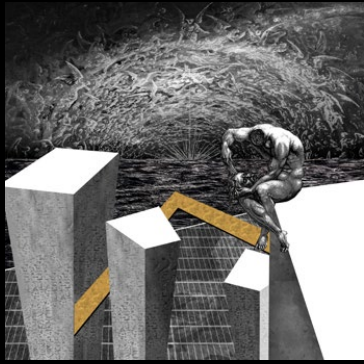
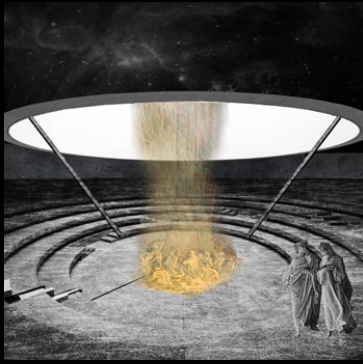

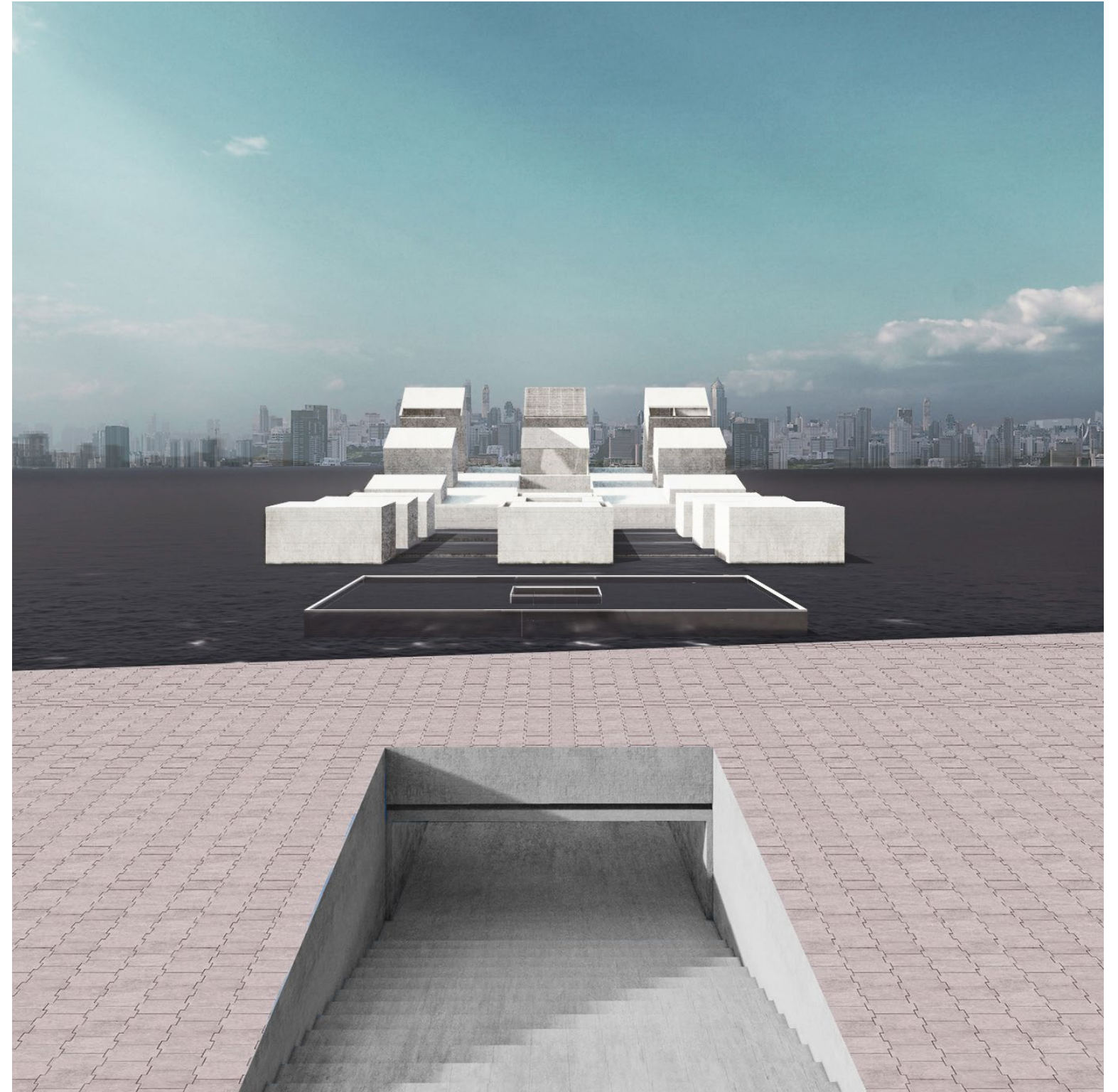
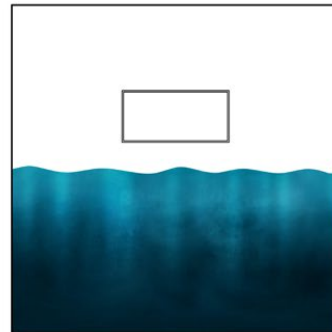
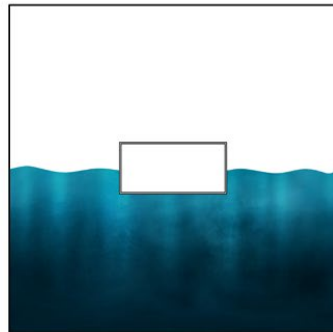
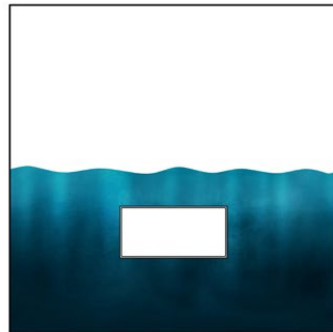

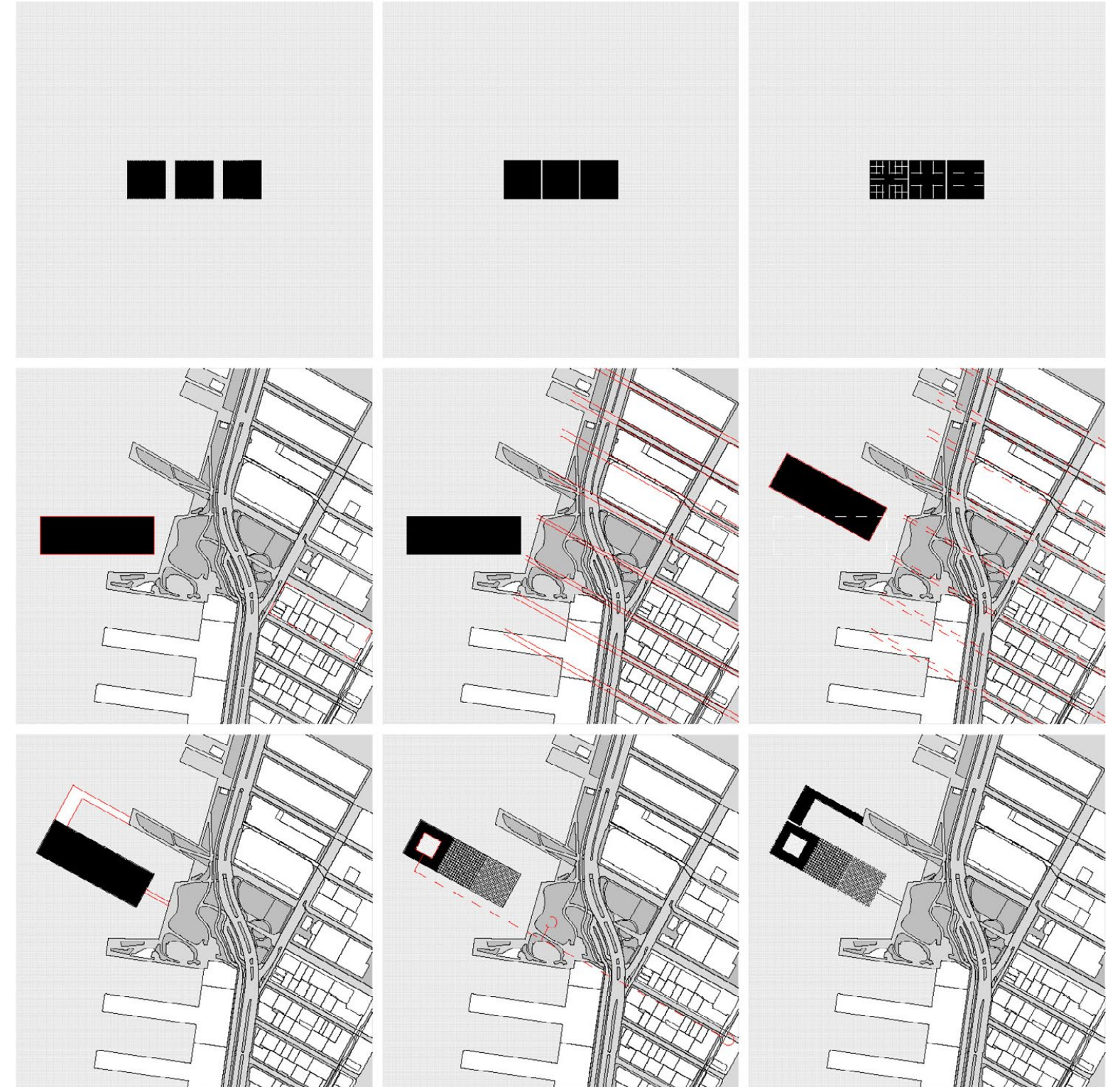

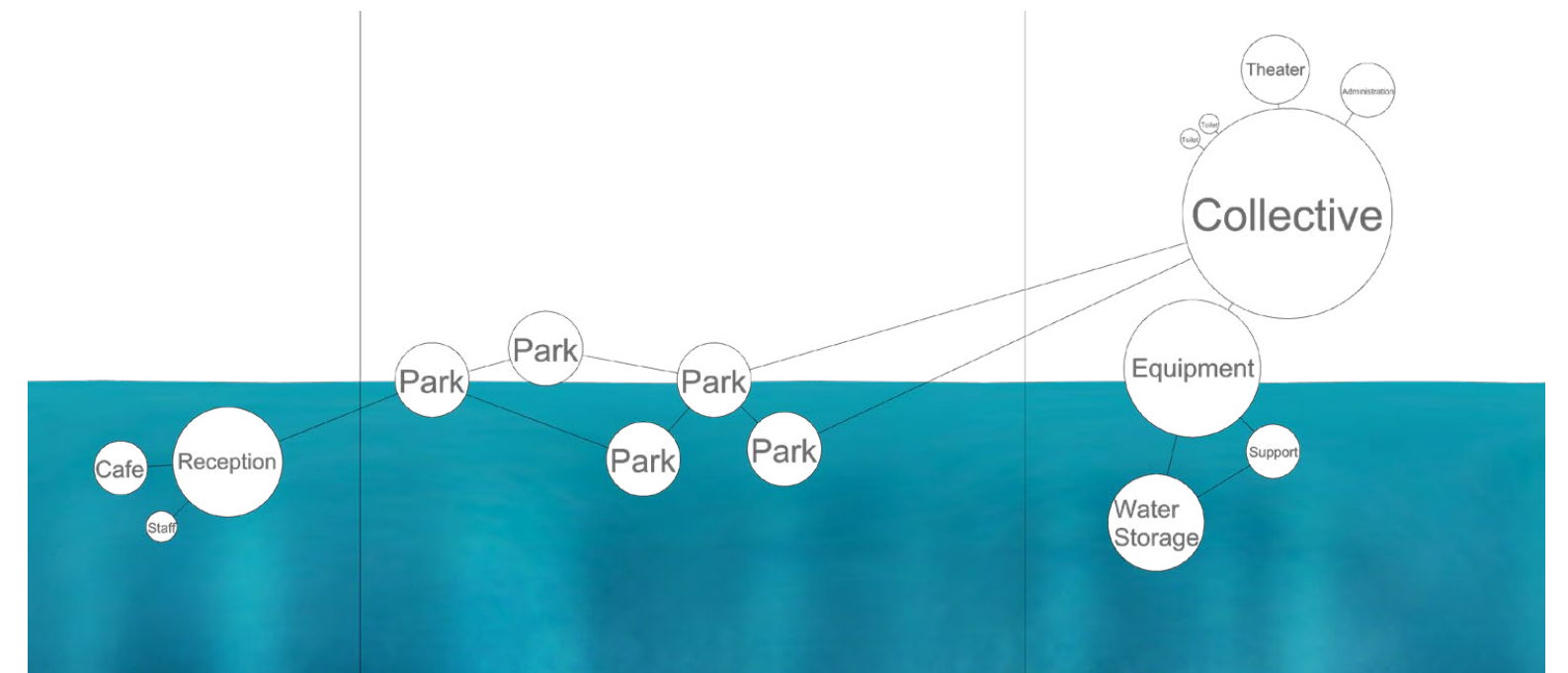
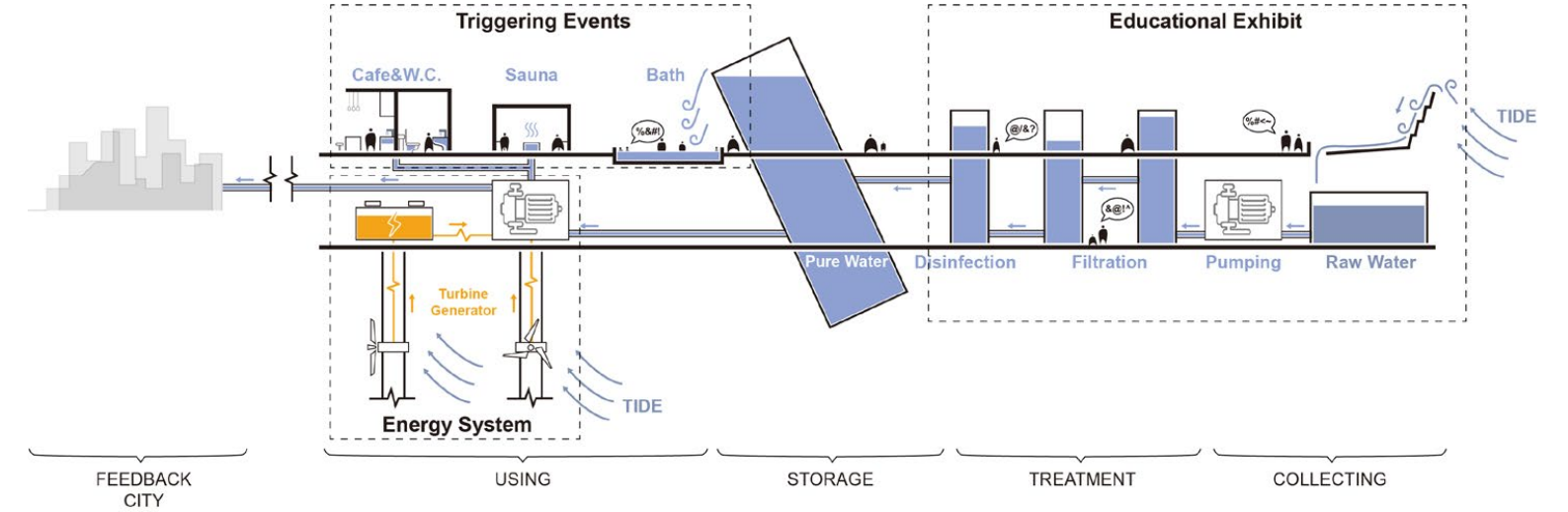
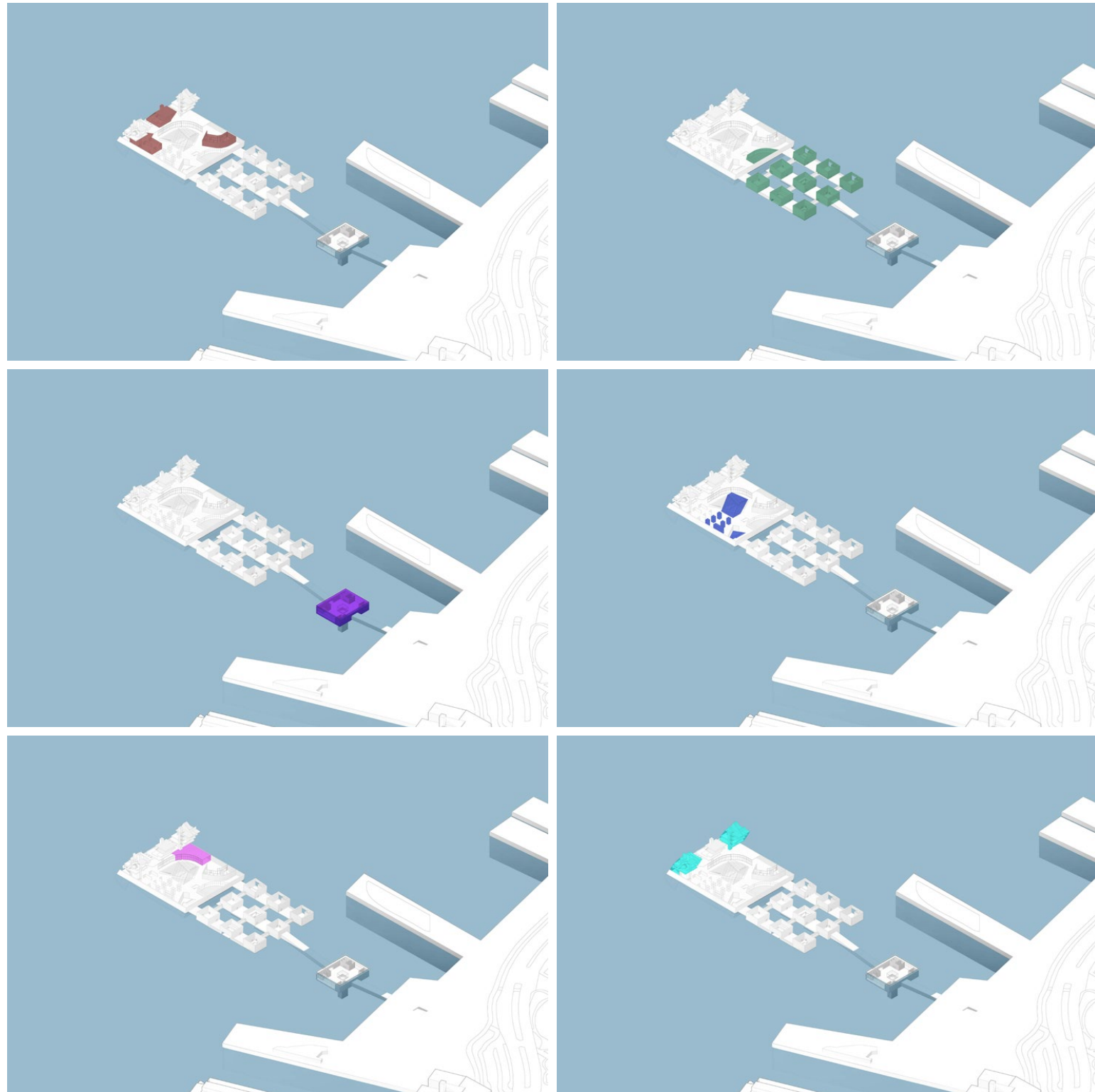

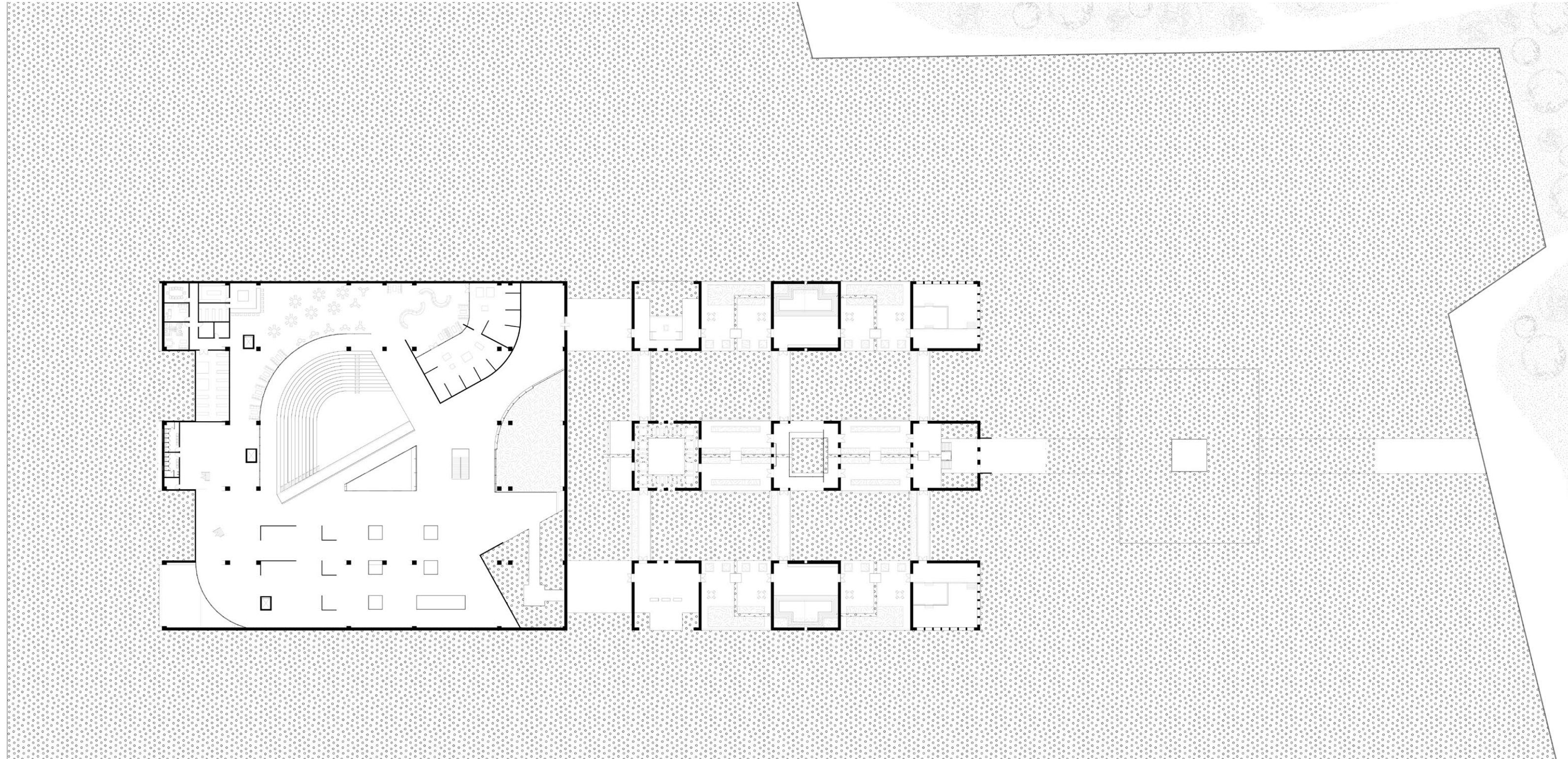

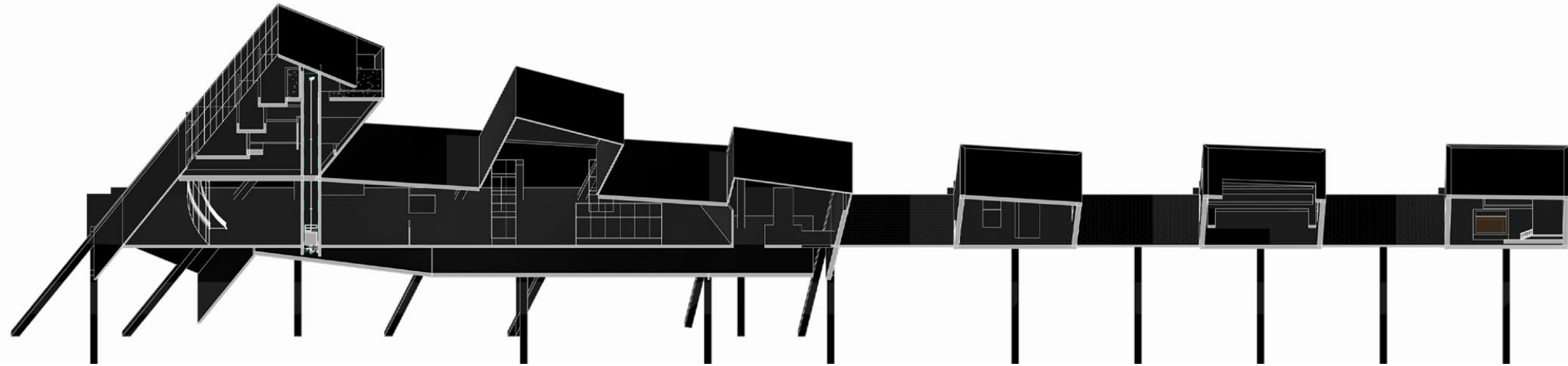
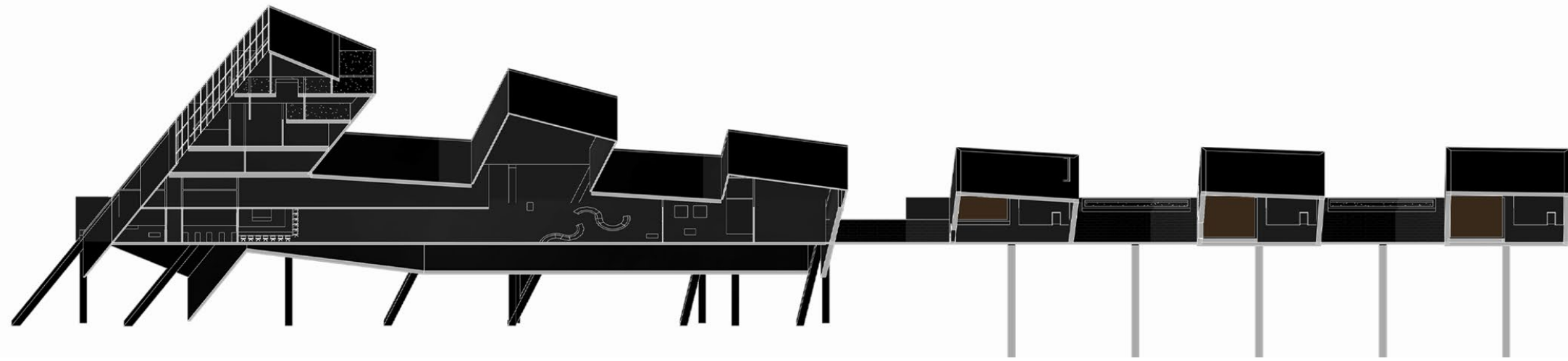

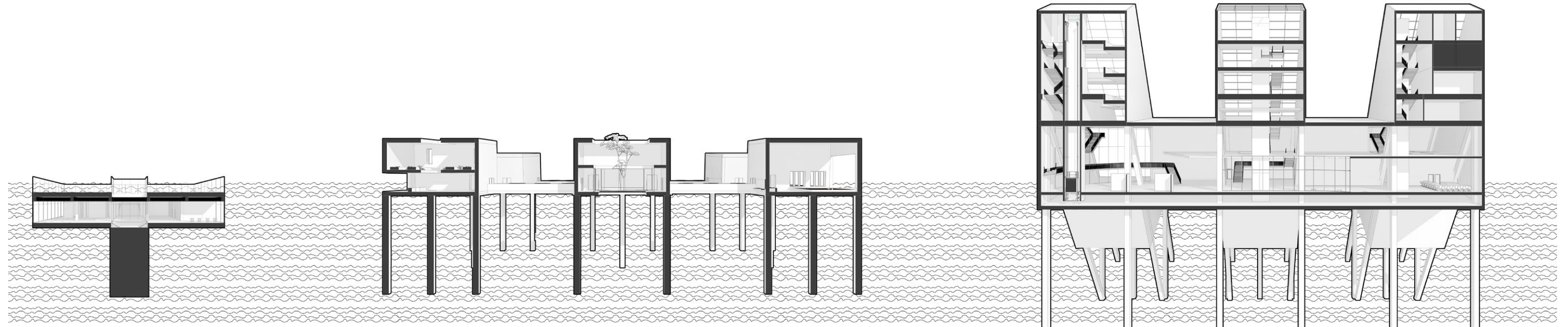
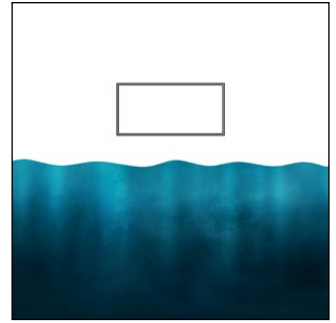
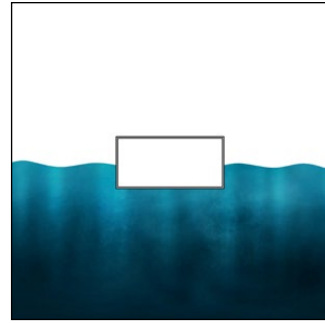
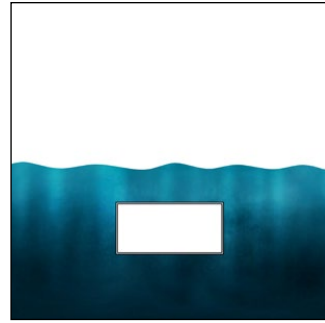

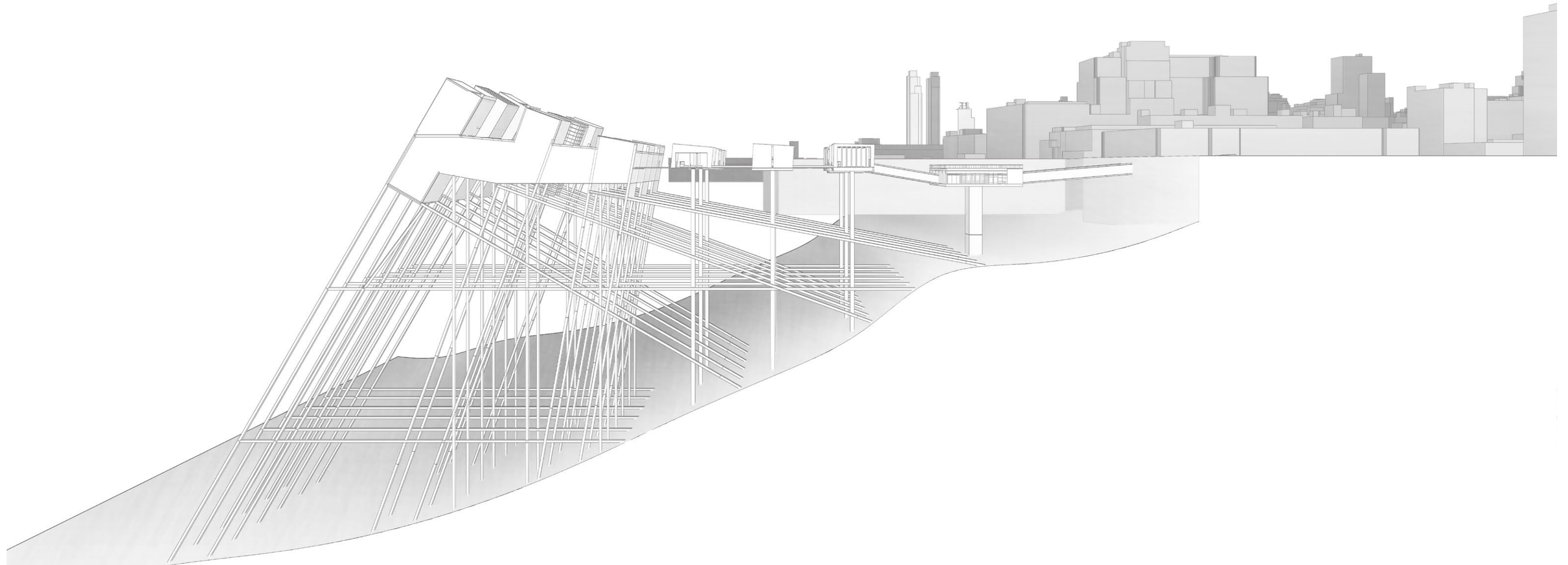
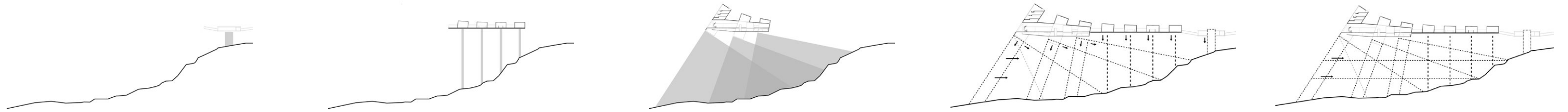

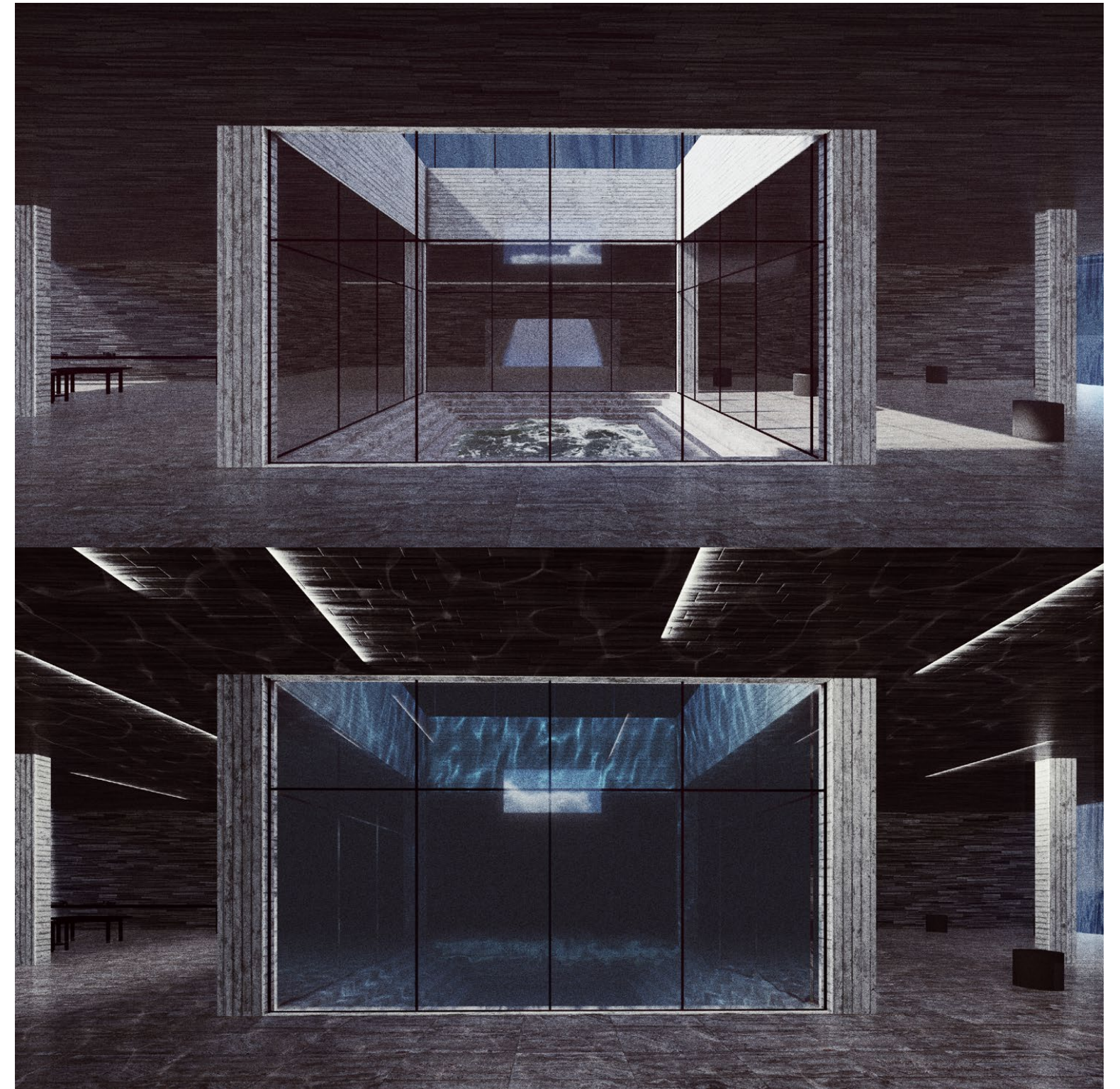

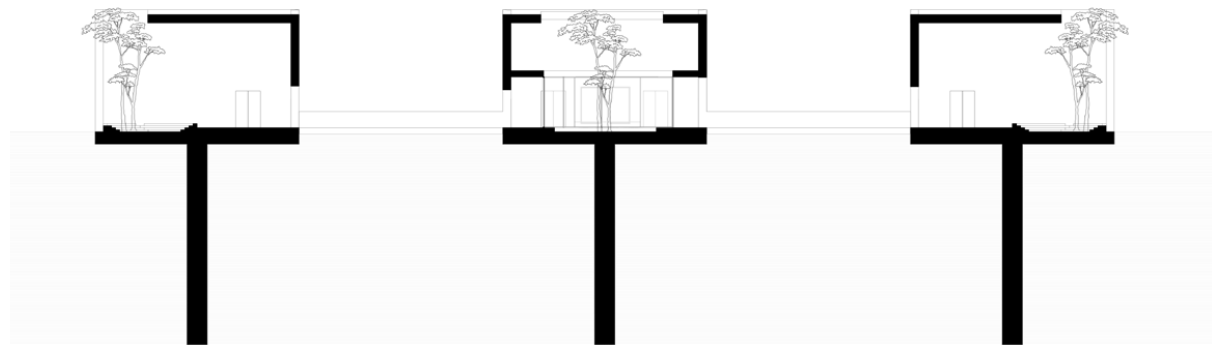
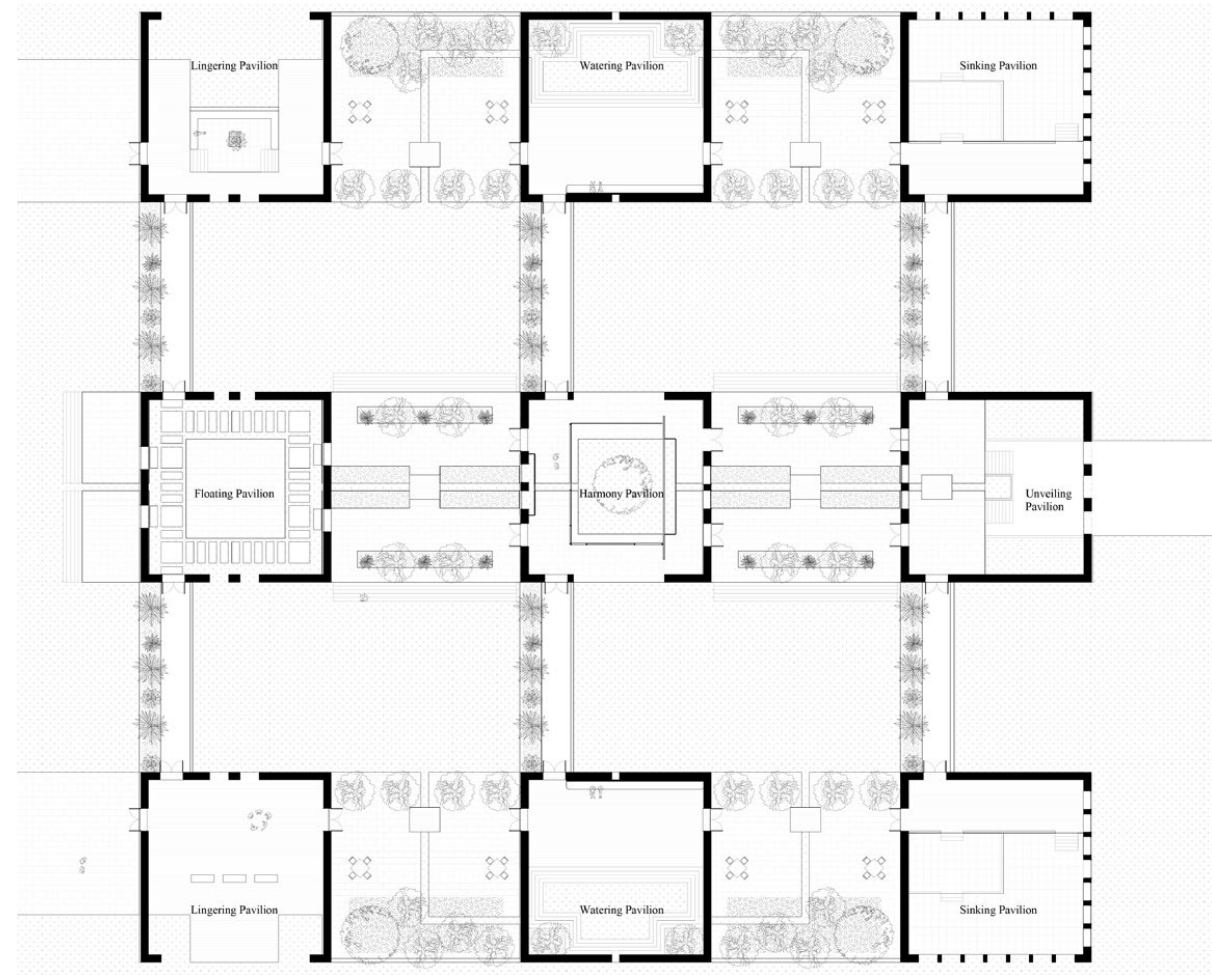

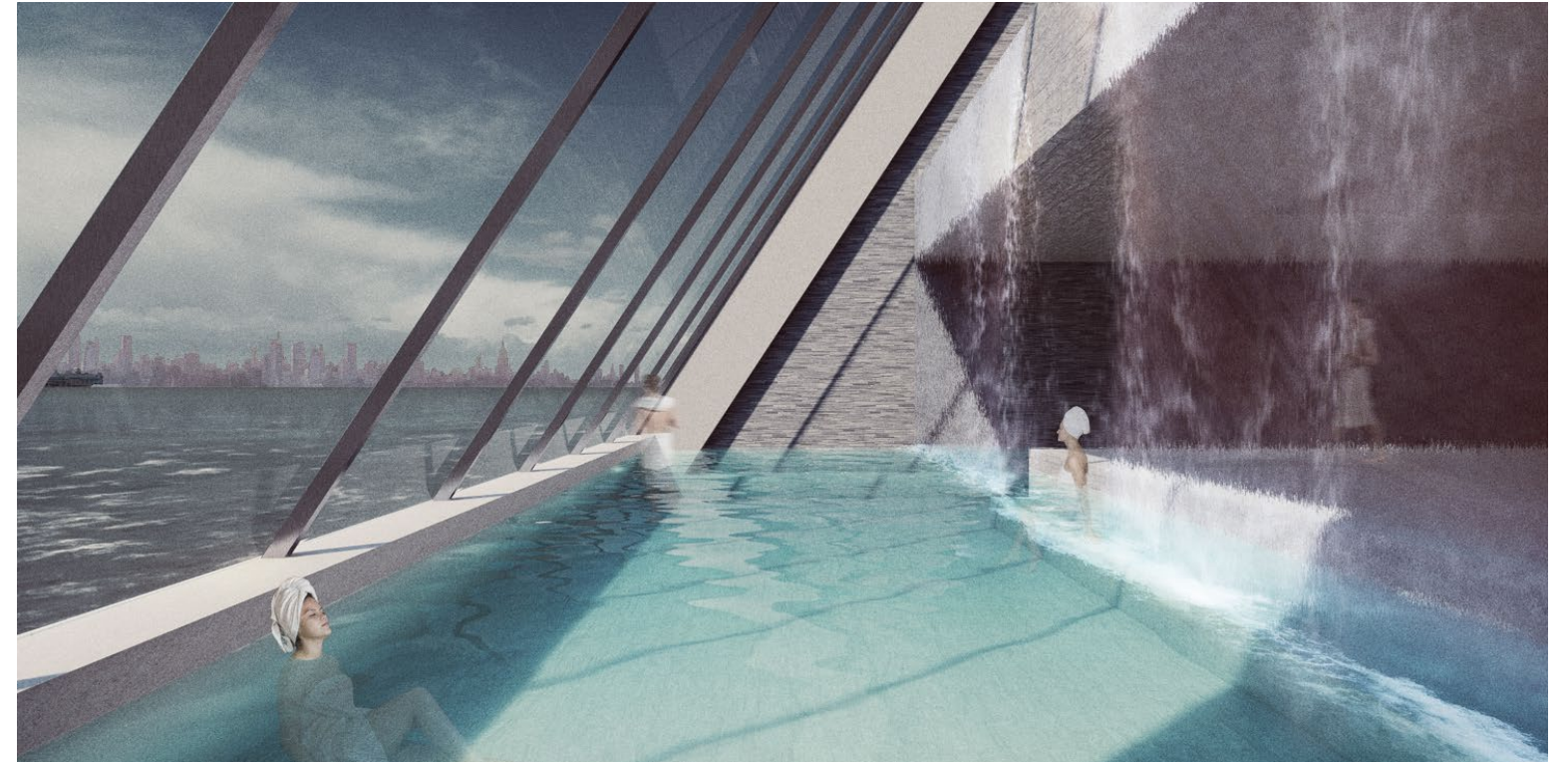
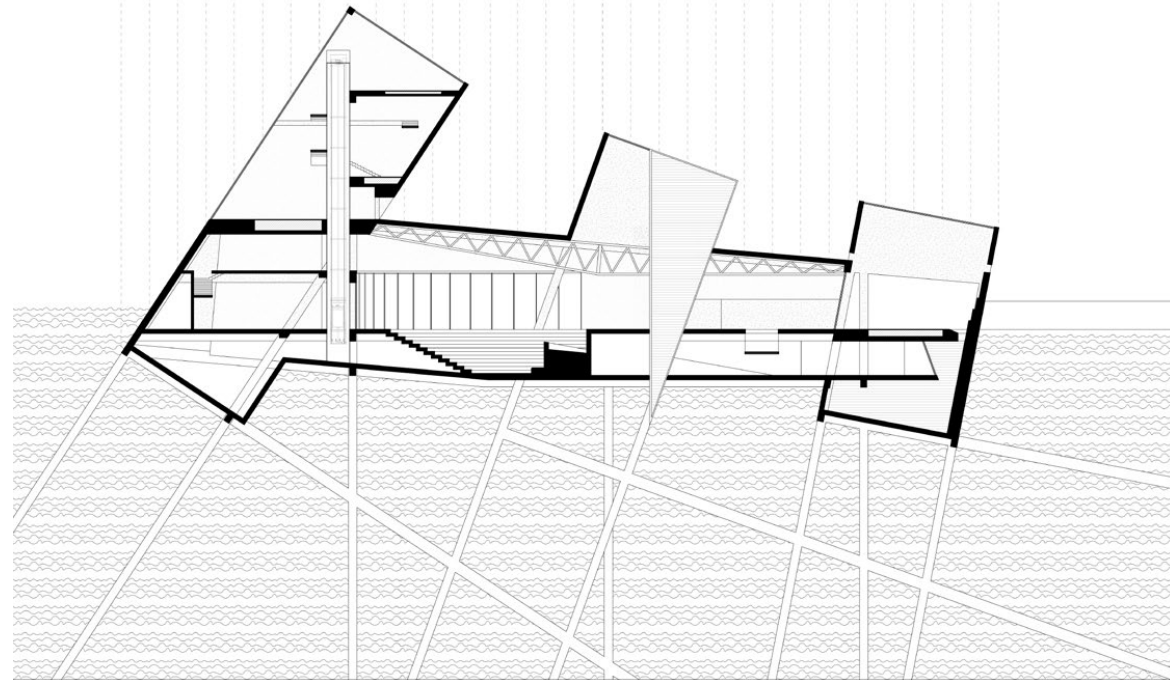
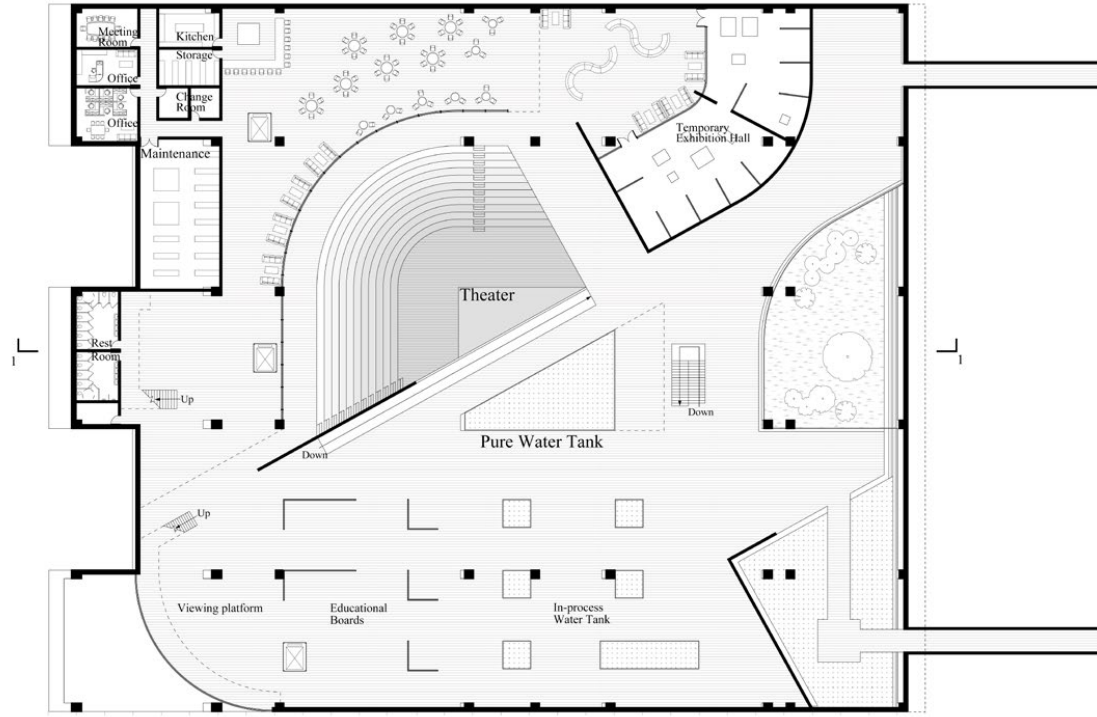

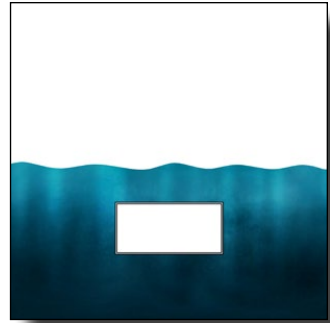

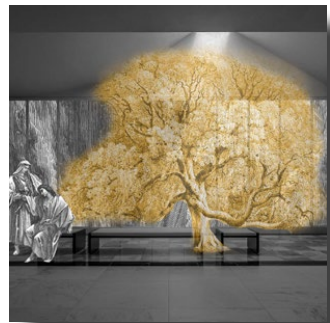
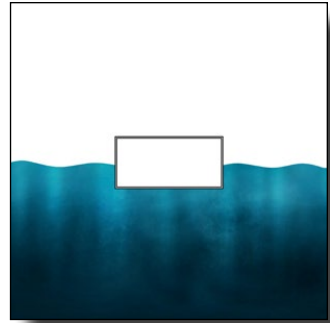

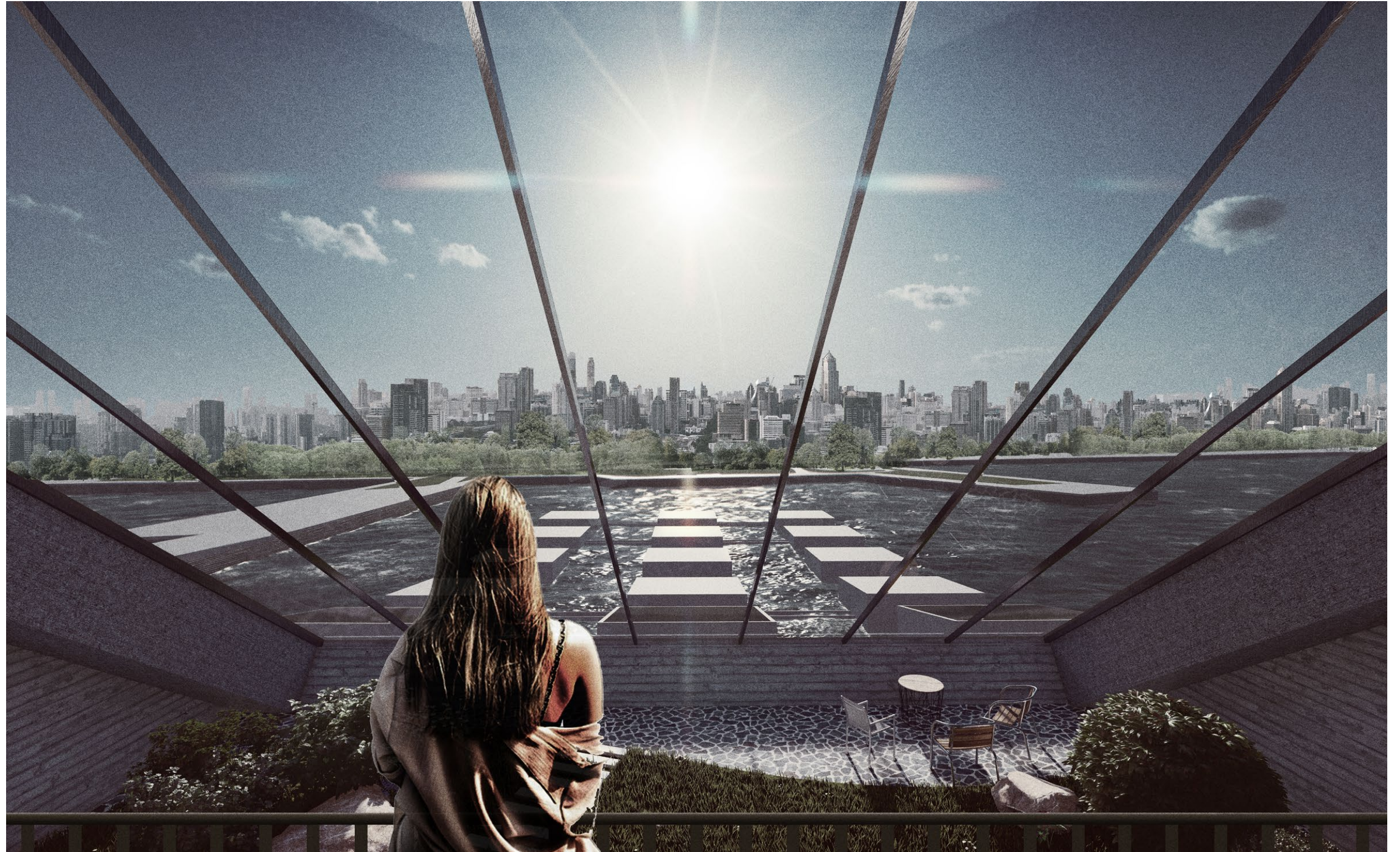
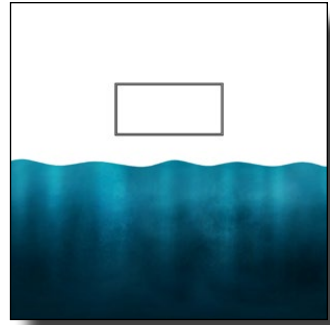

04 ASCENDING CLIFFS

STUDIO VI

LOCATION:	LAS VEGAS, NV
TYPE:	HOTEL, FARM
DATE:	SPRING, 2022
INSTRUCTOR:	GARY BATES

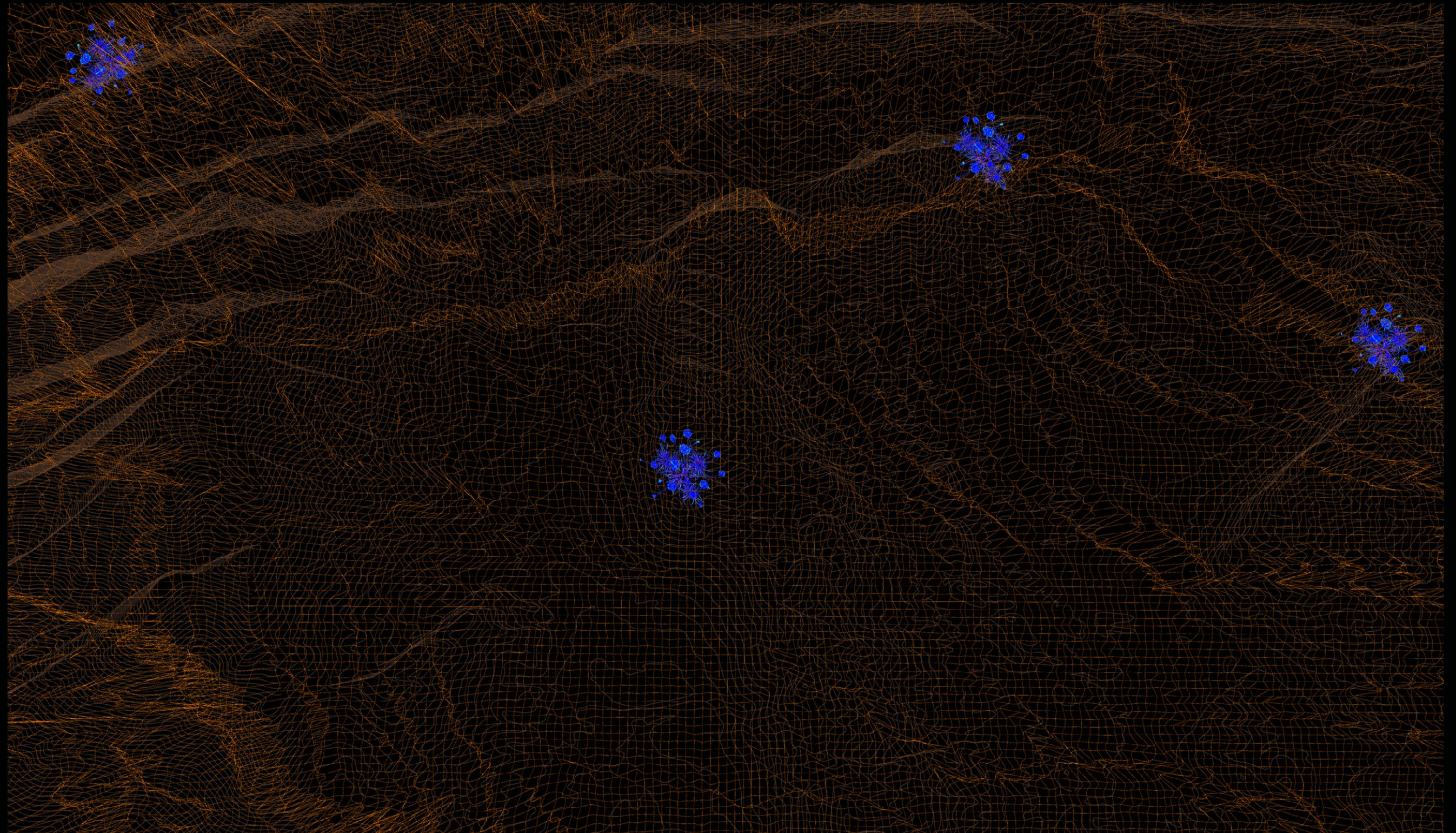

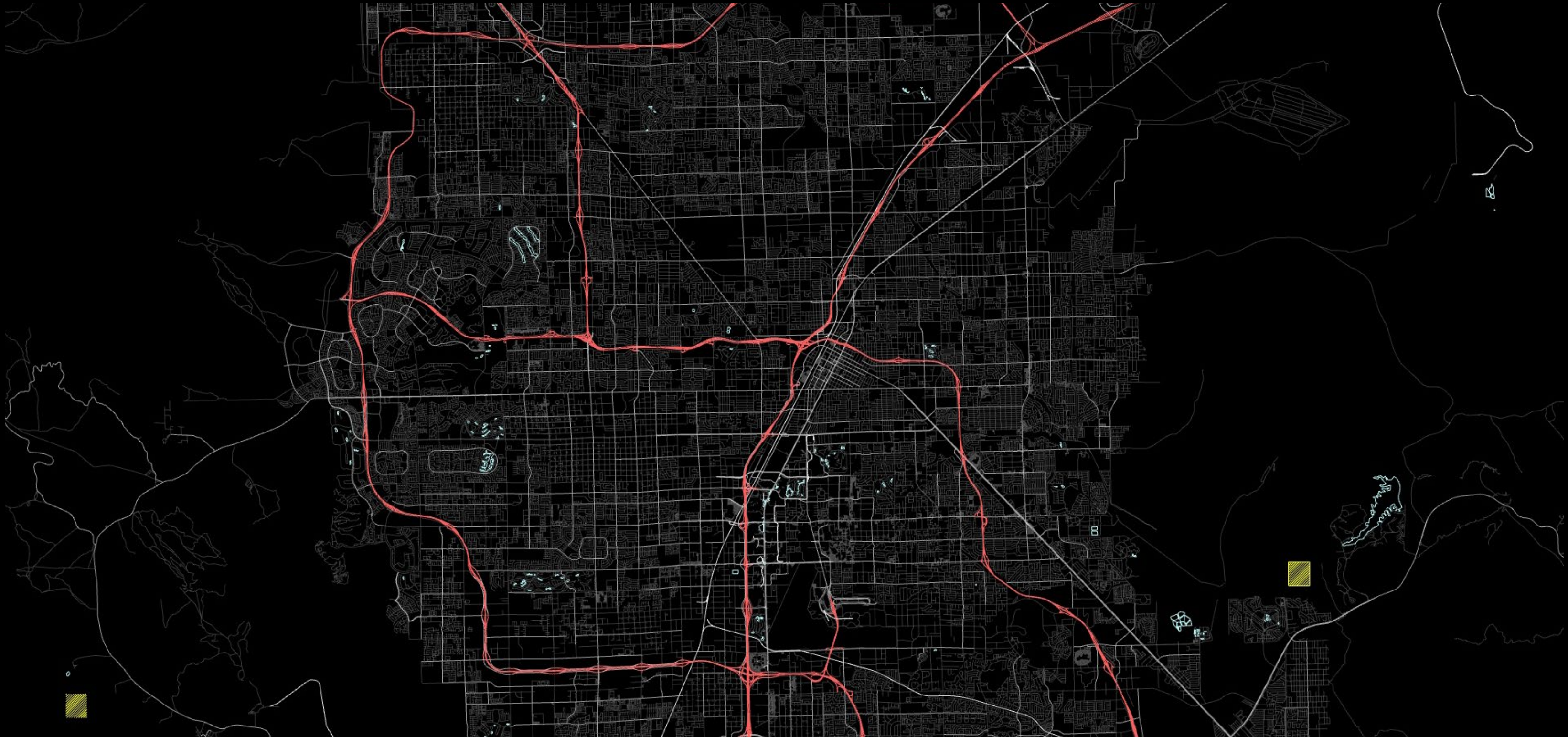

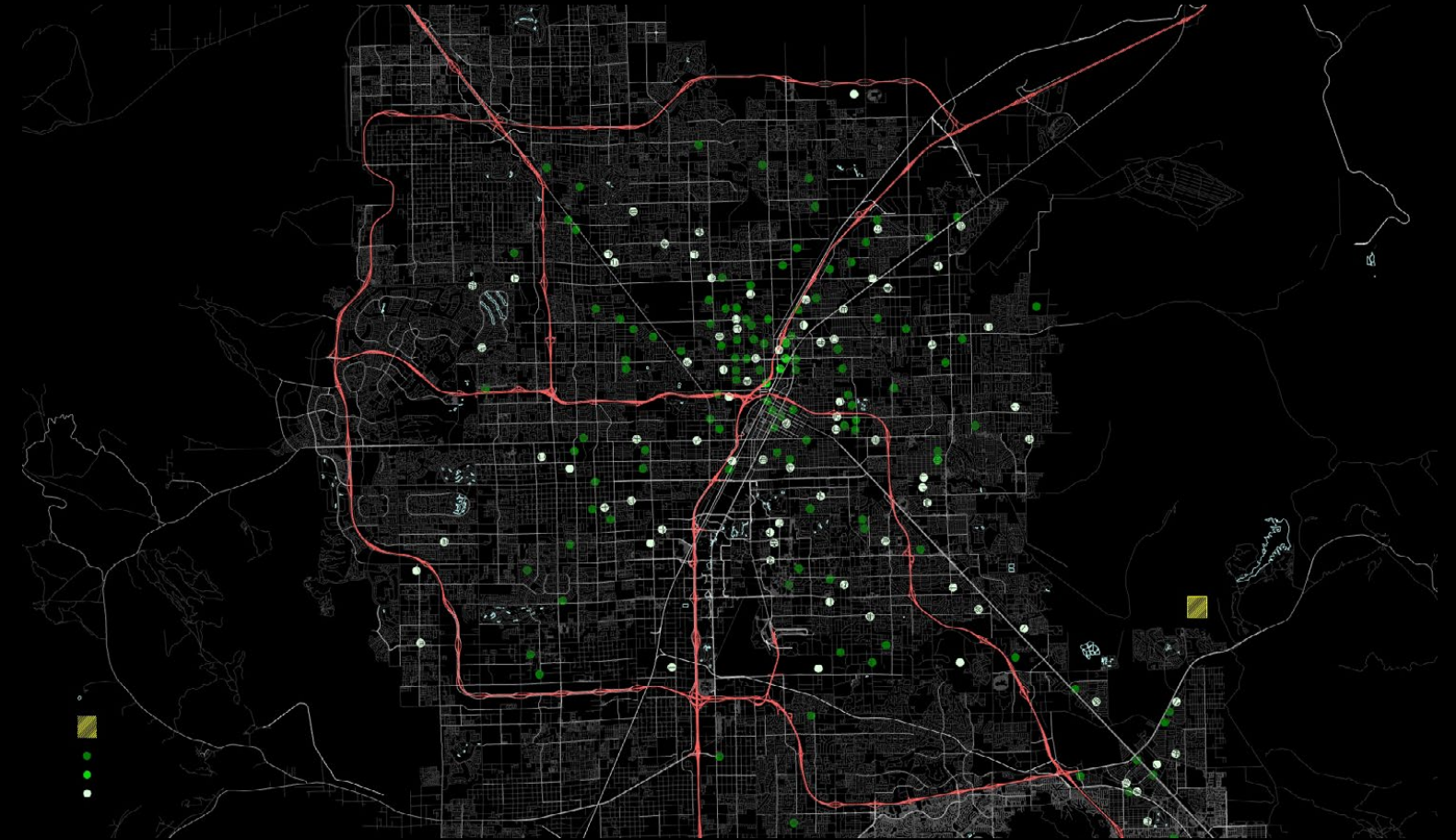
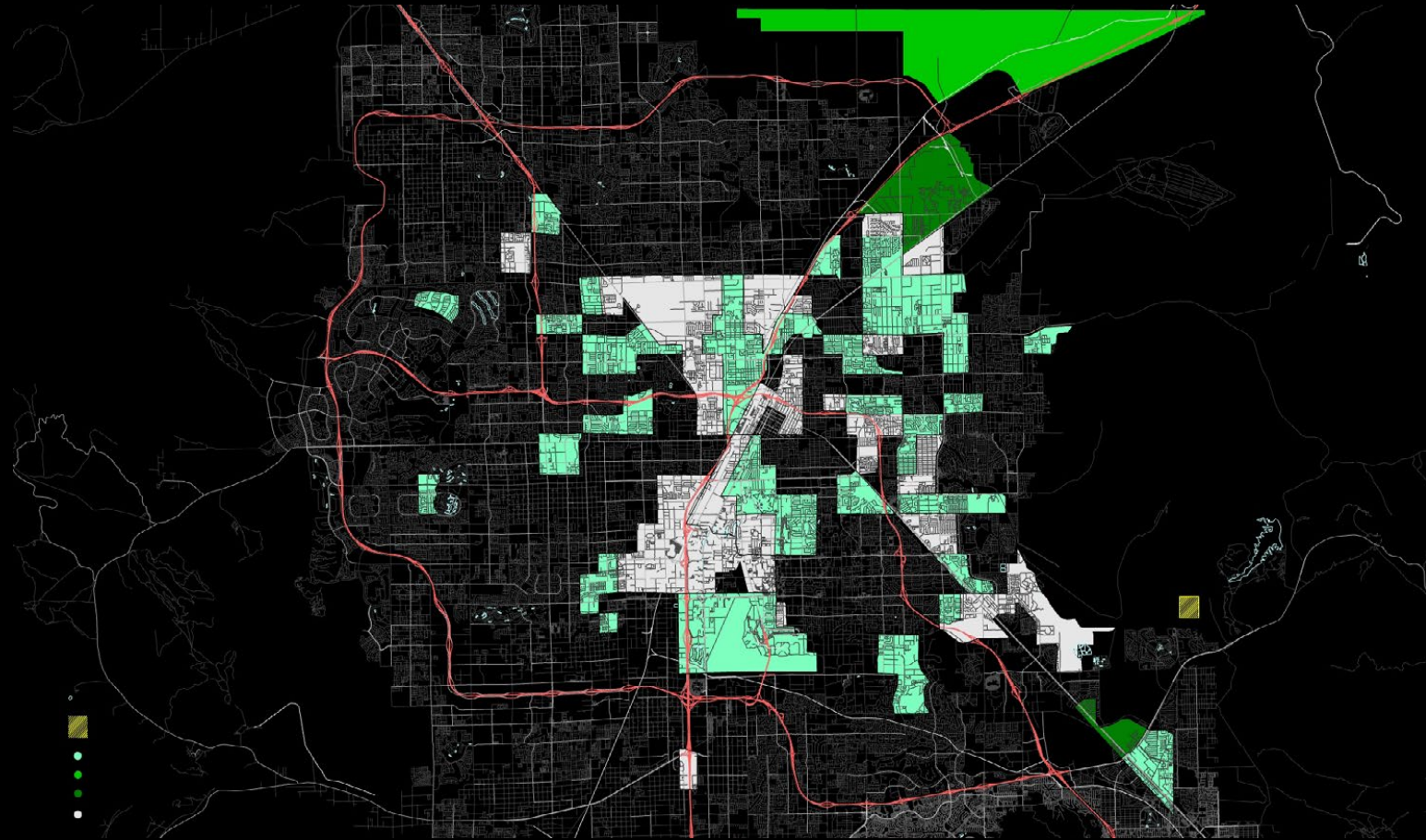

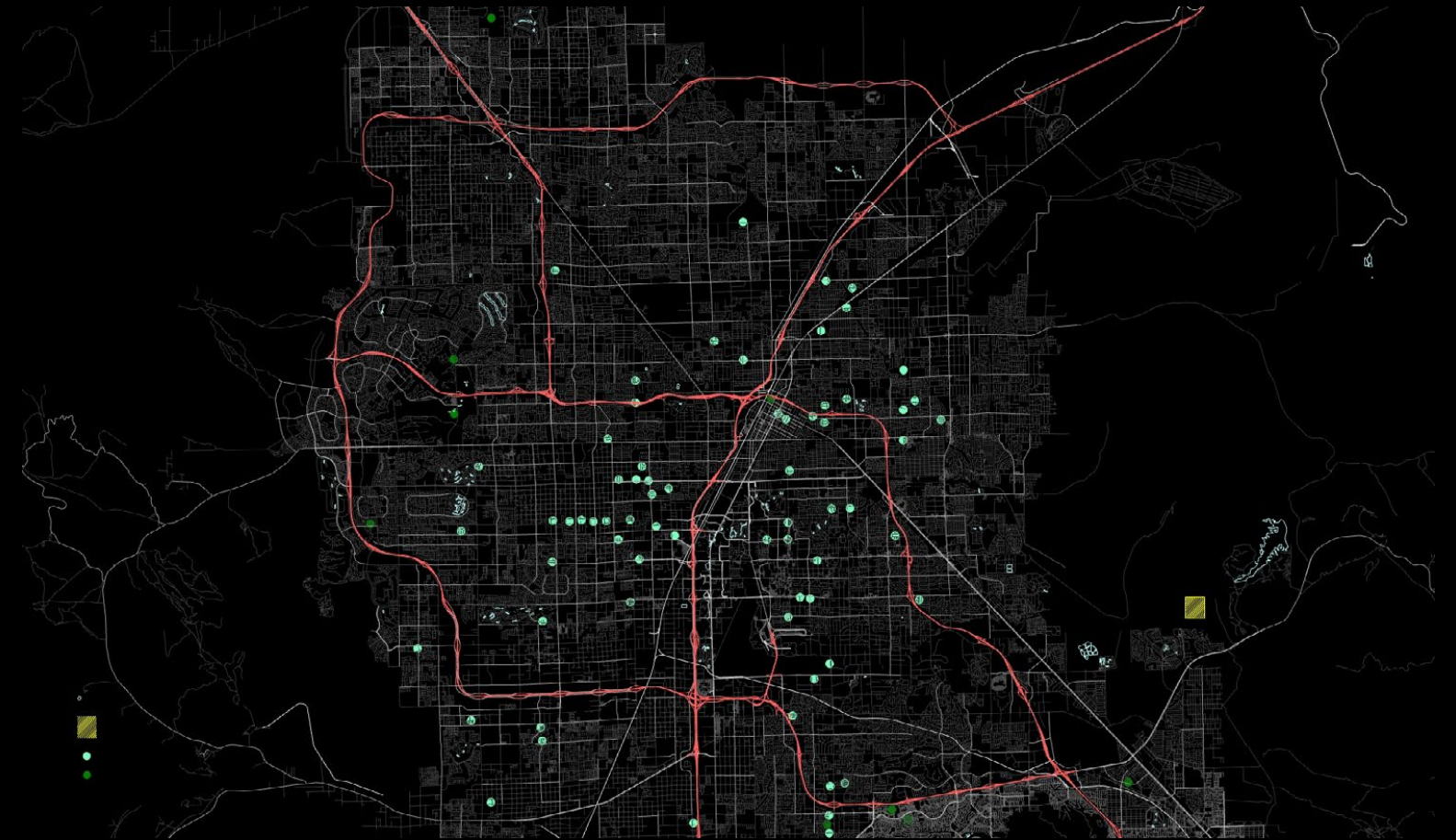
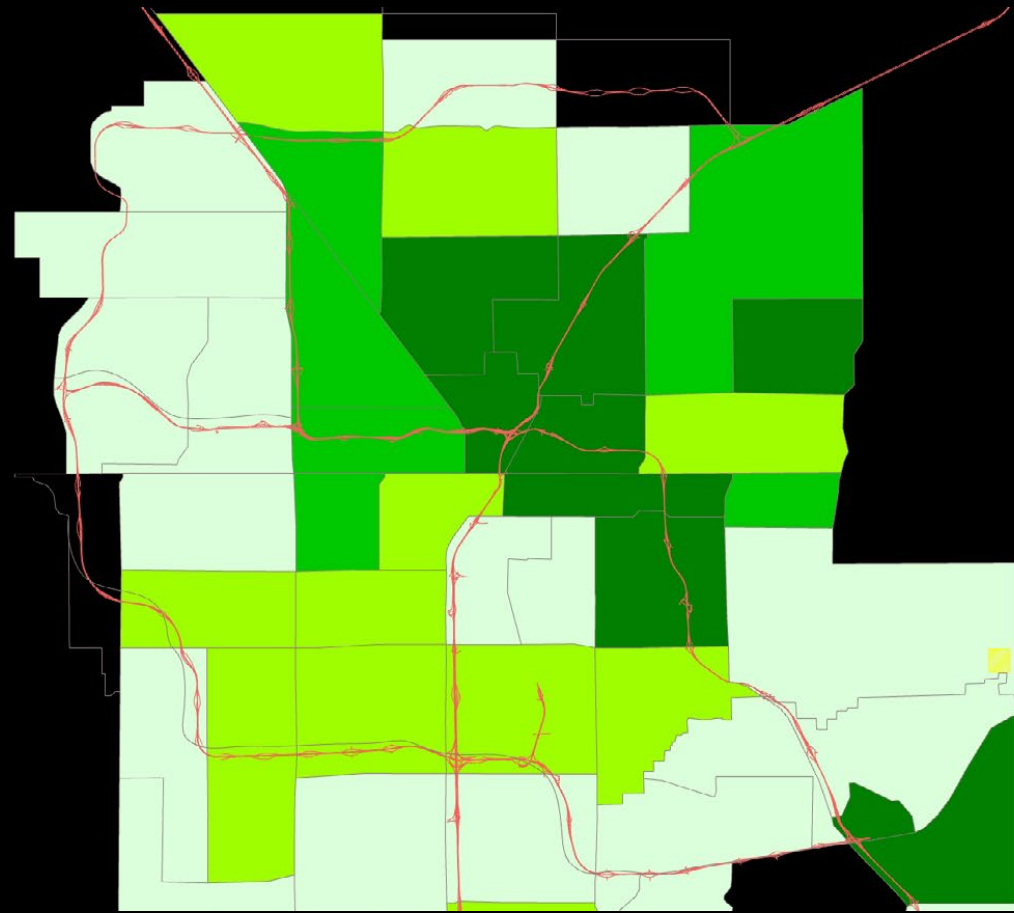

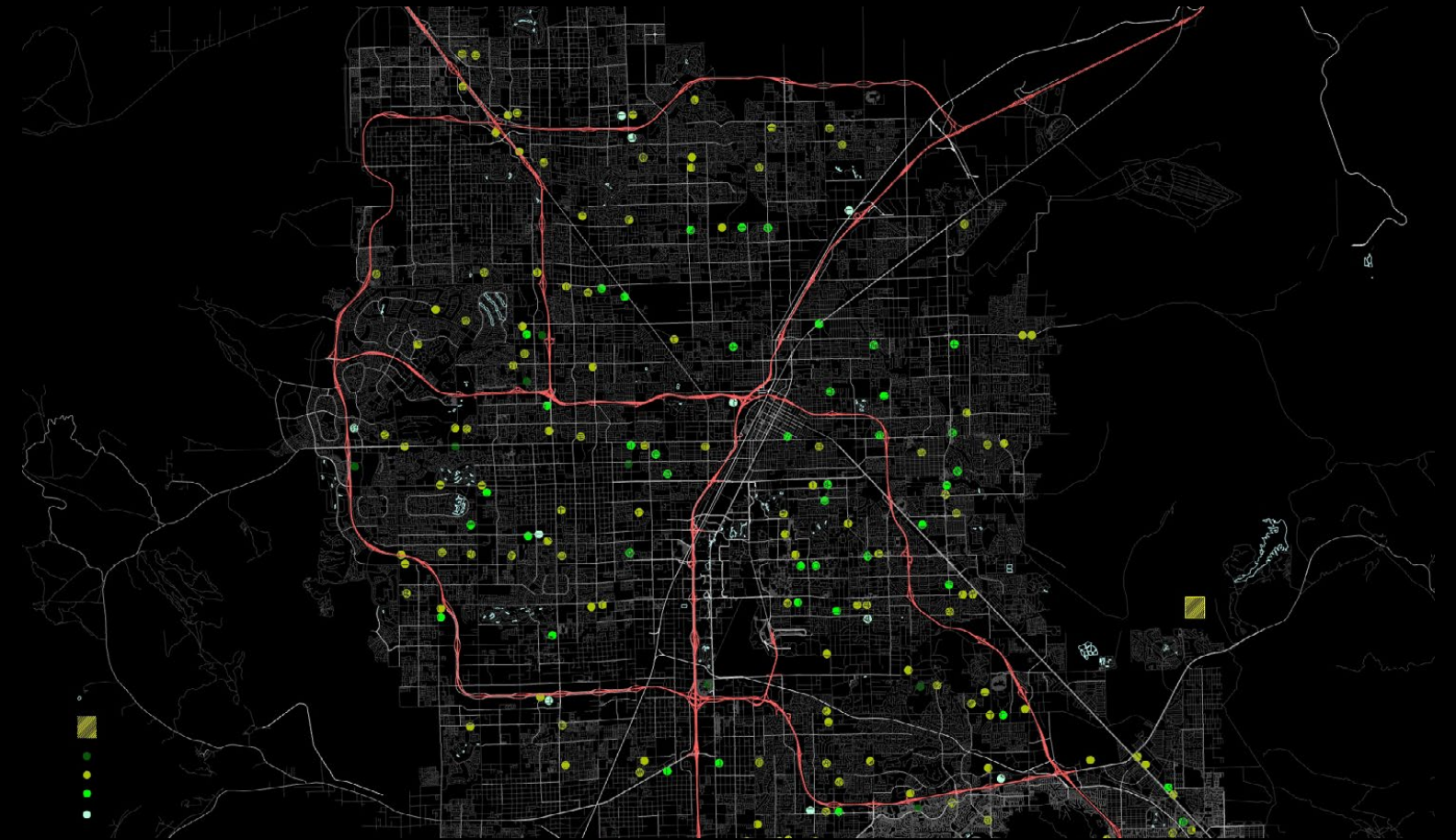
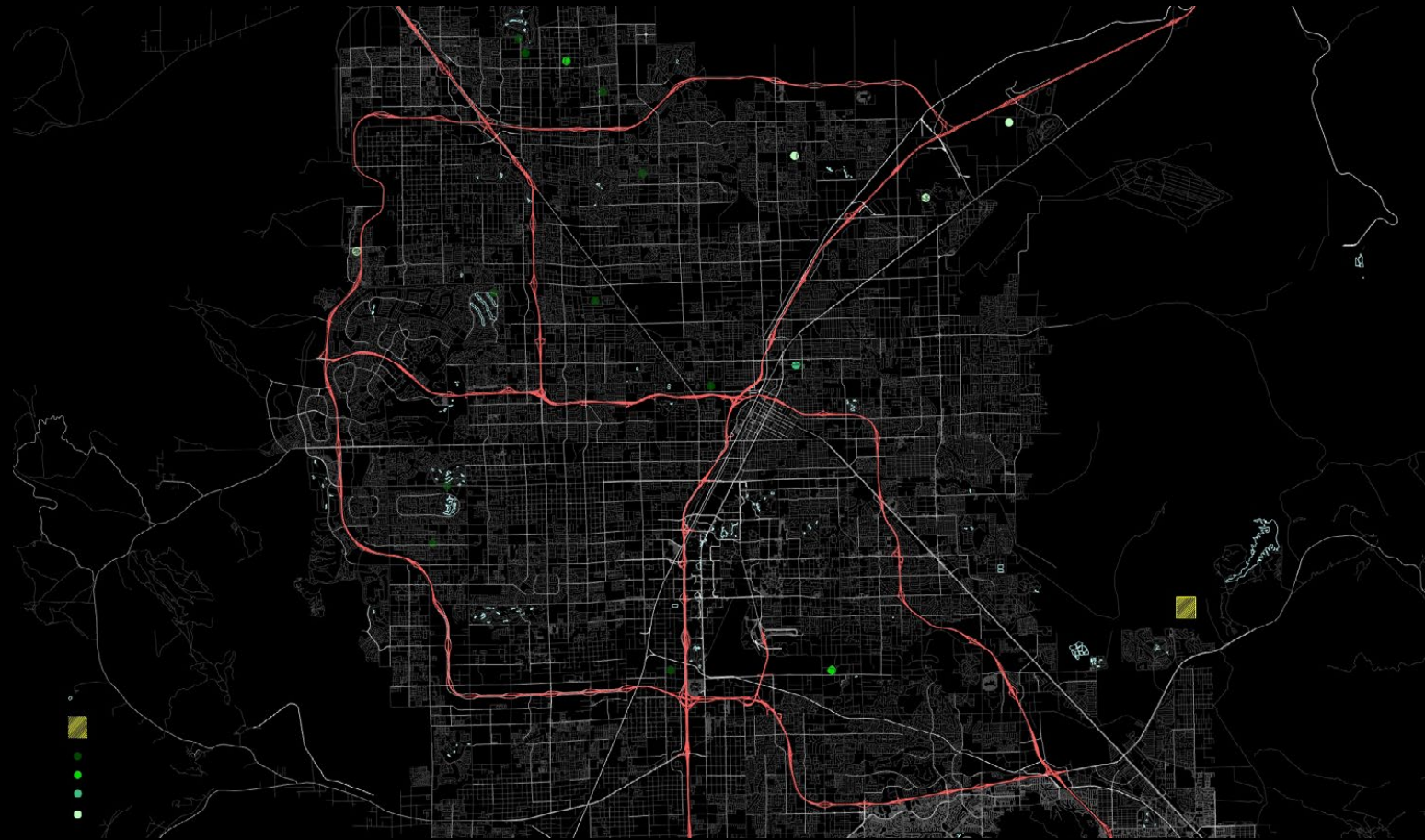

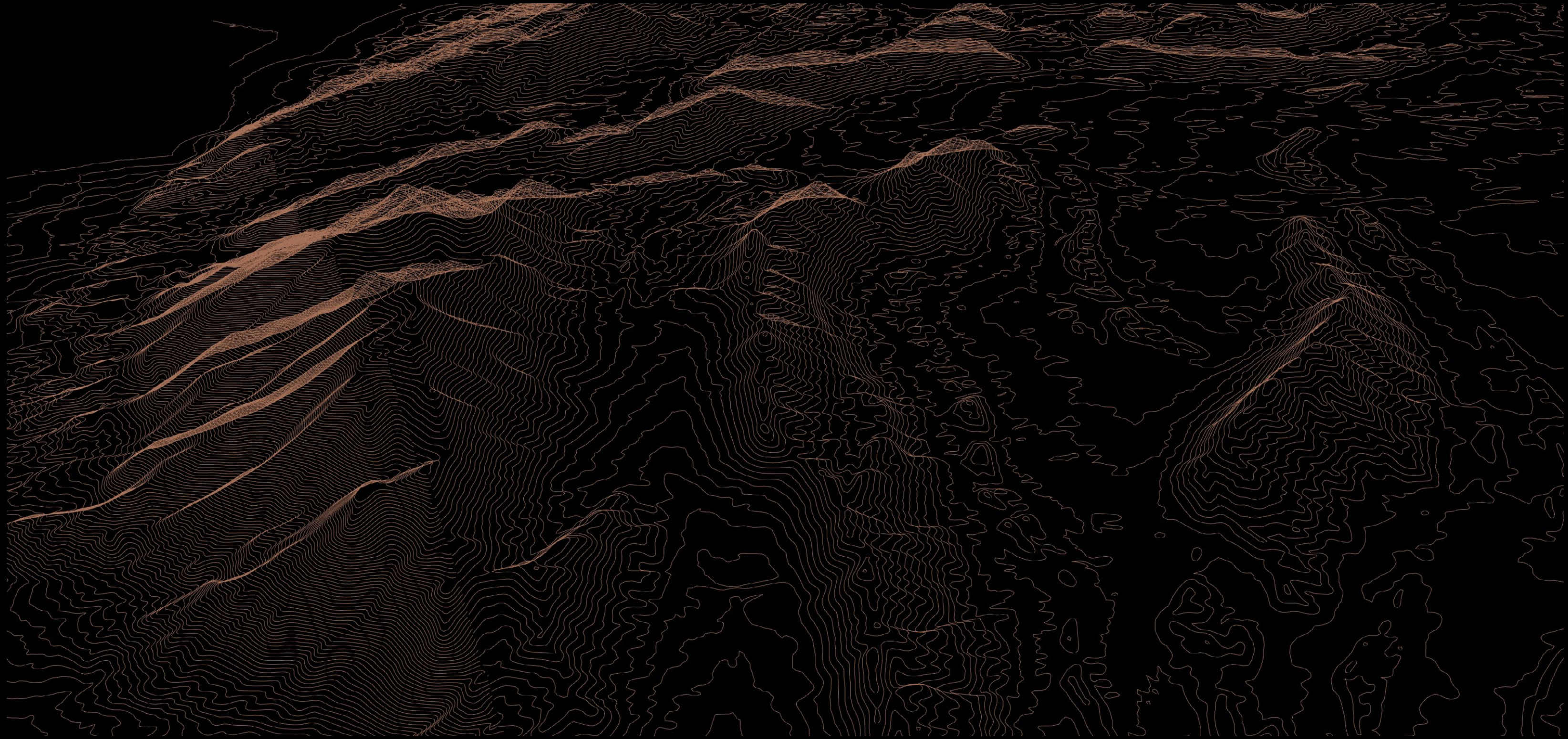

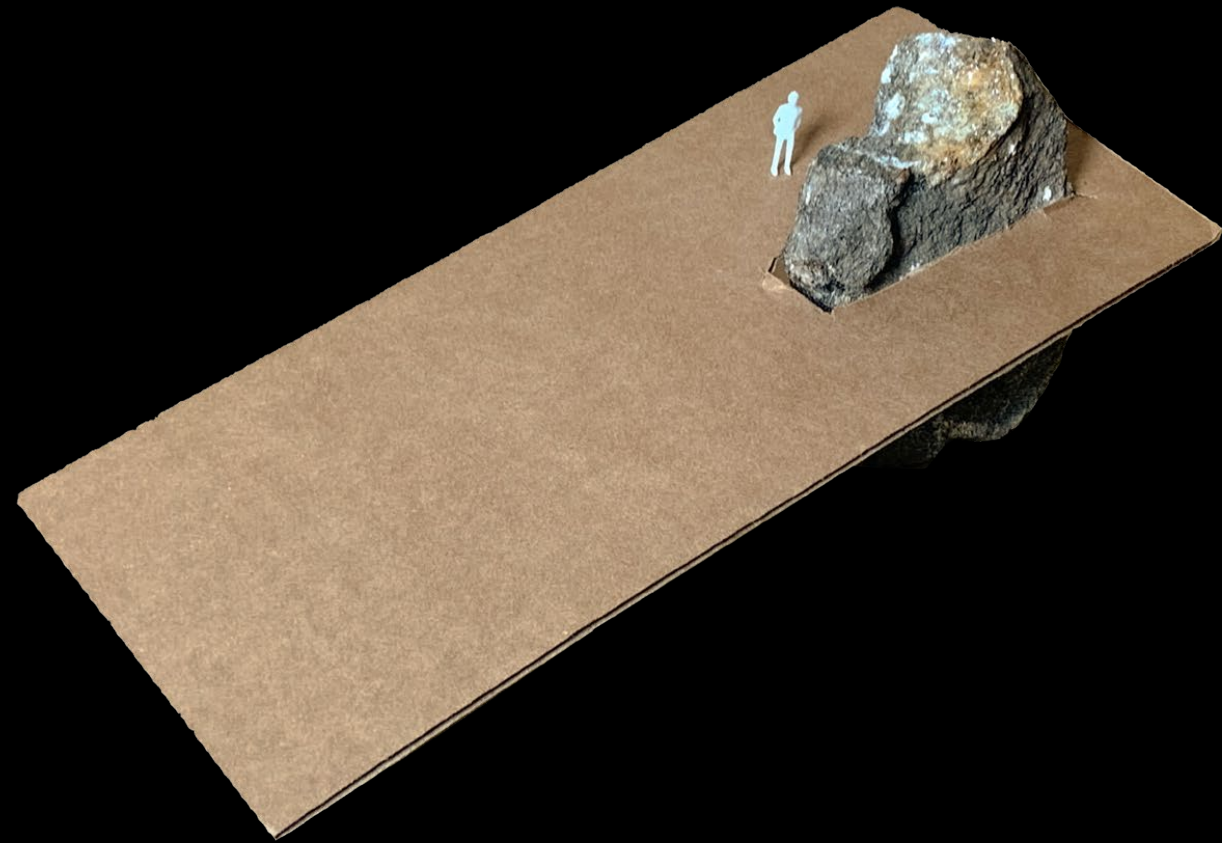

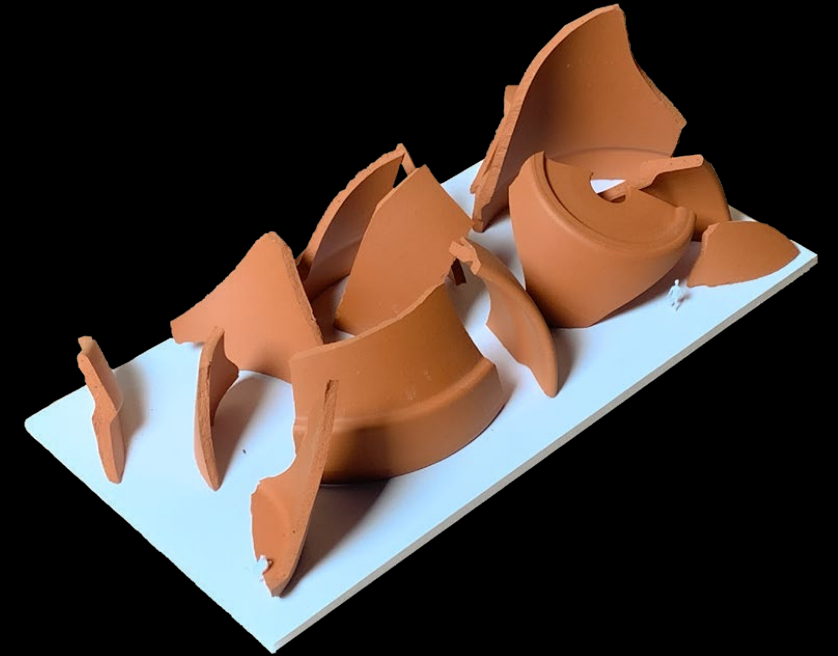
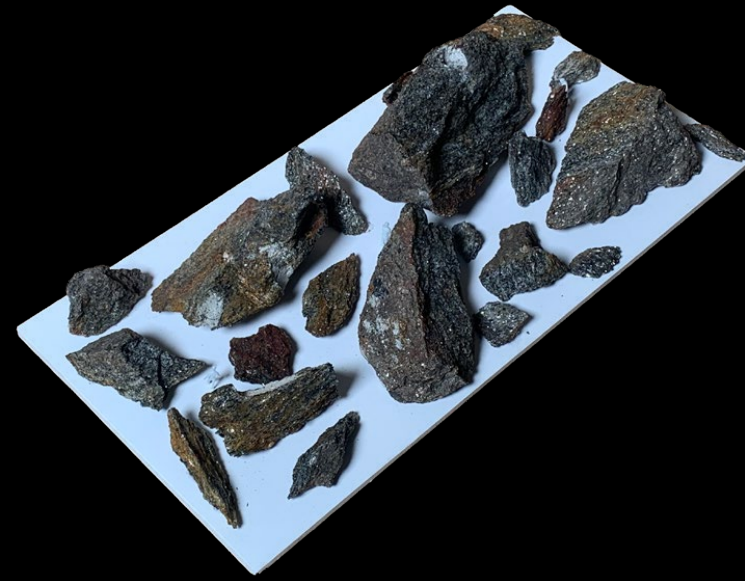
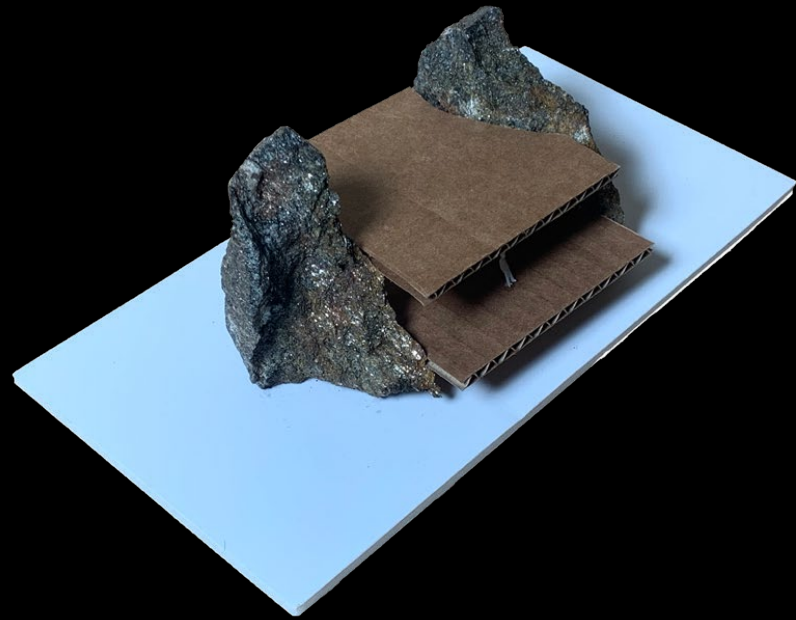



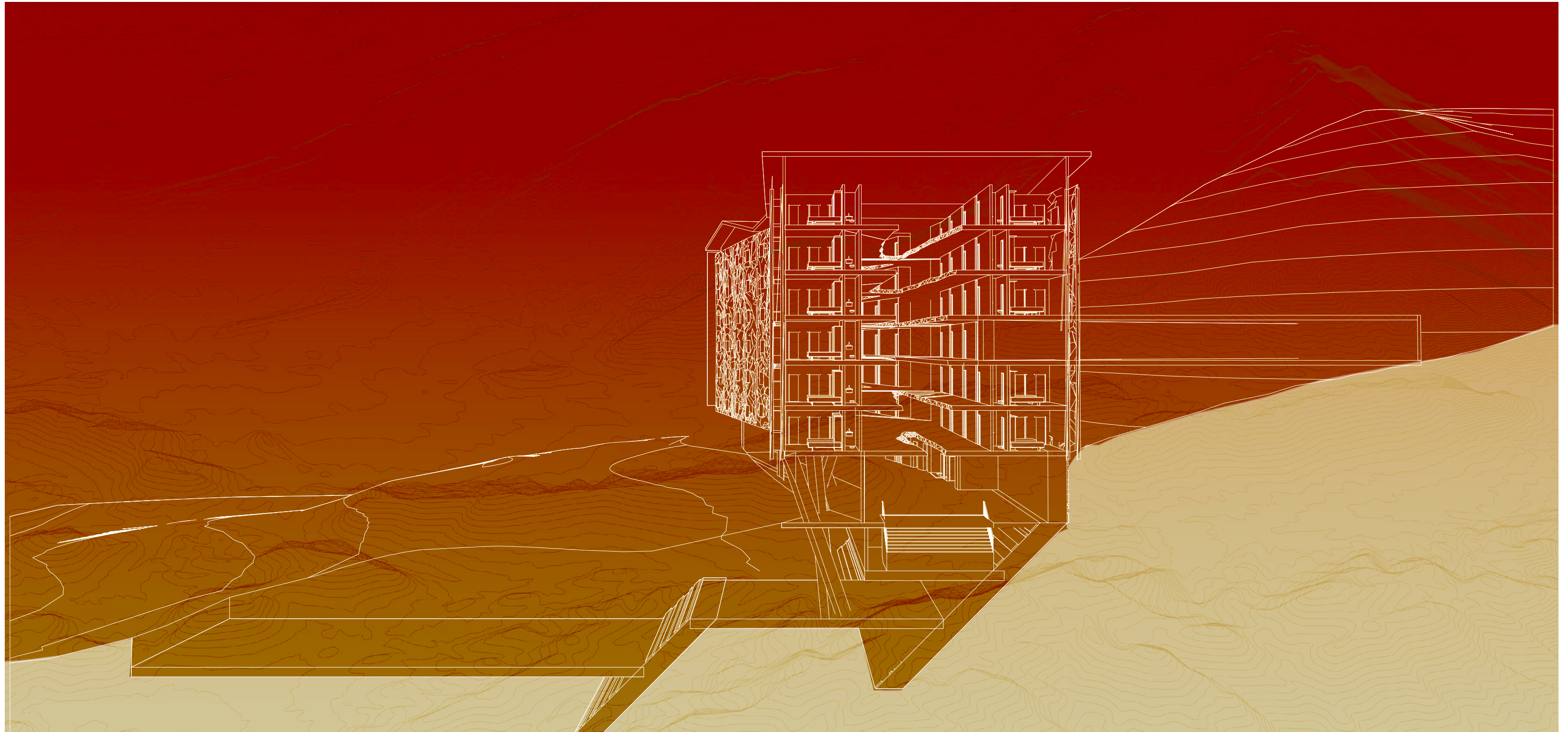

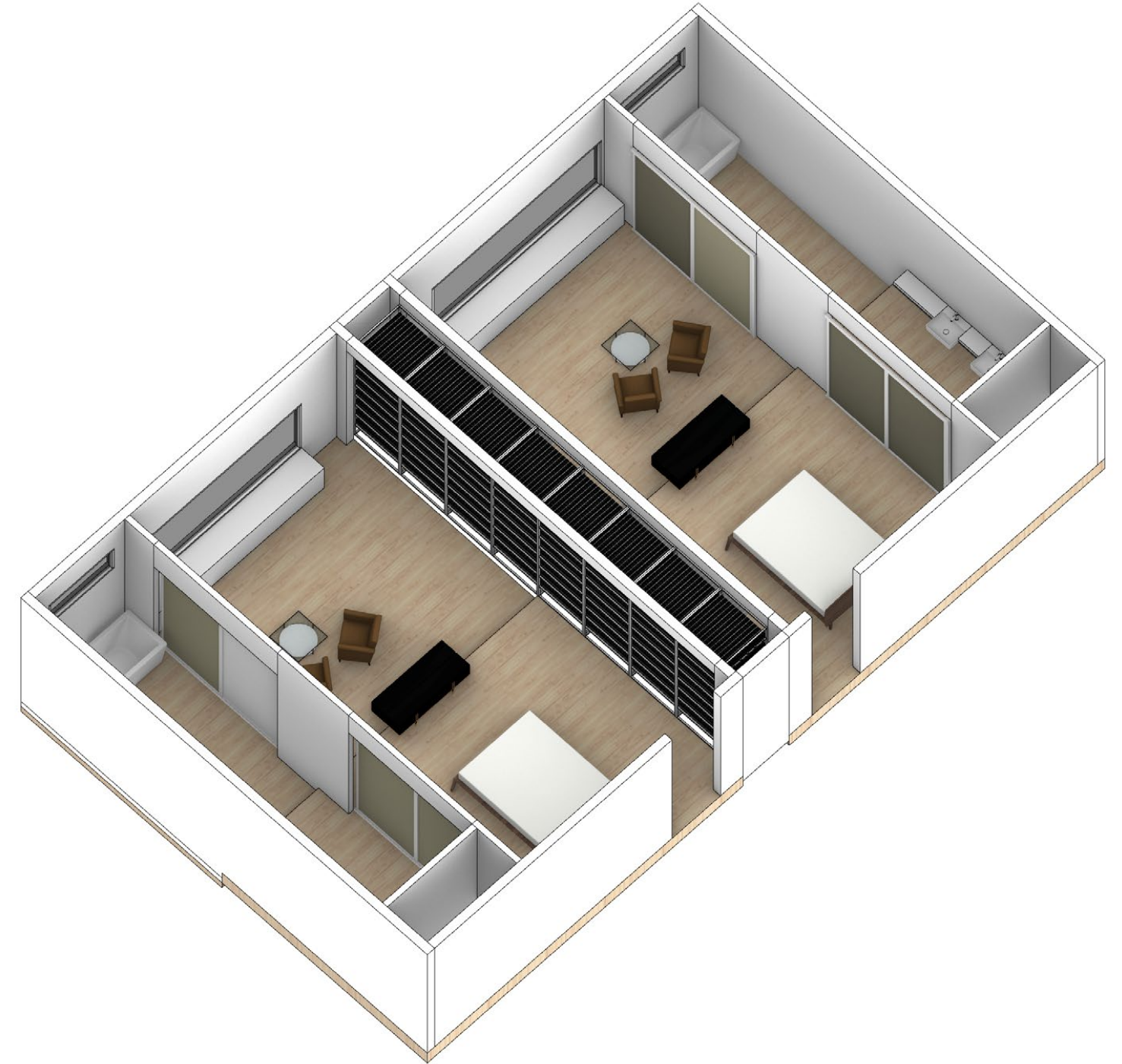
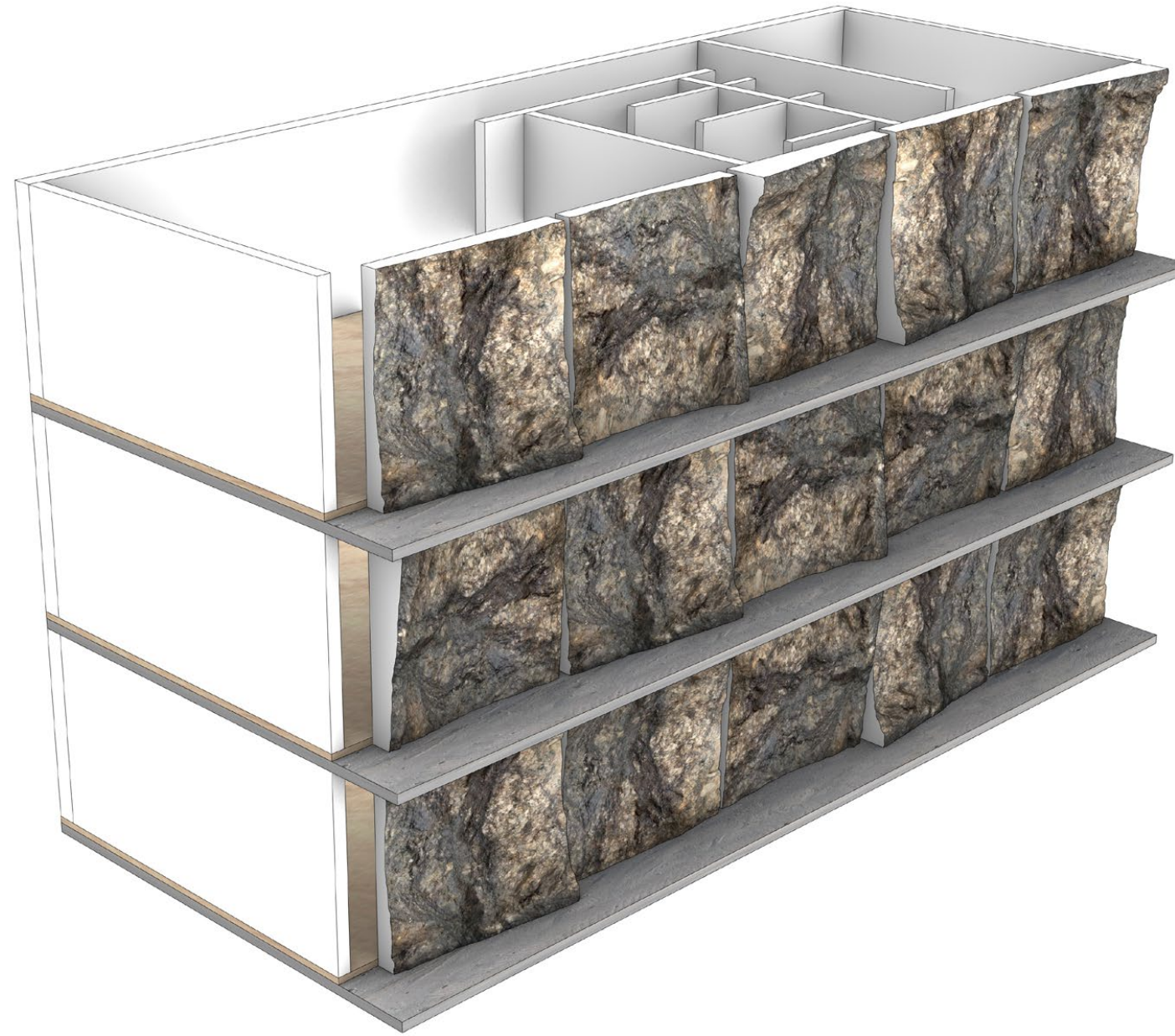

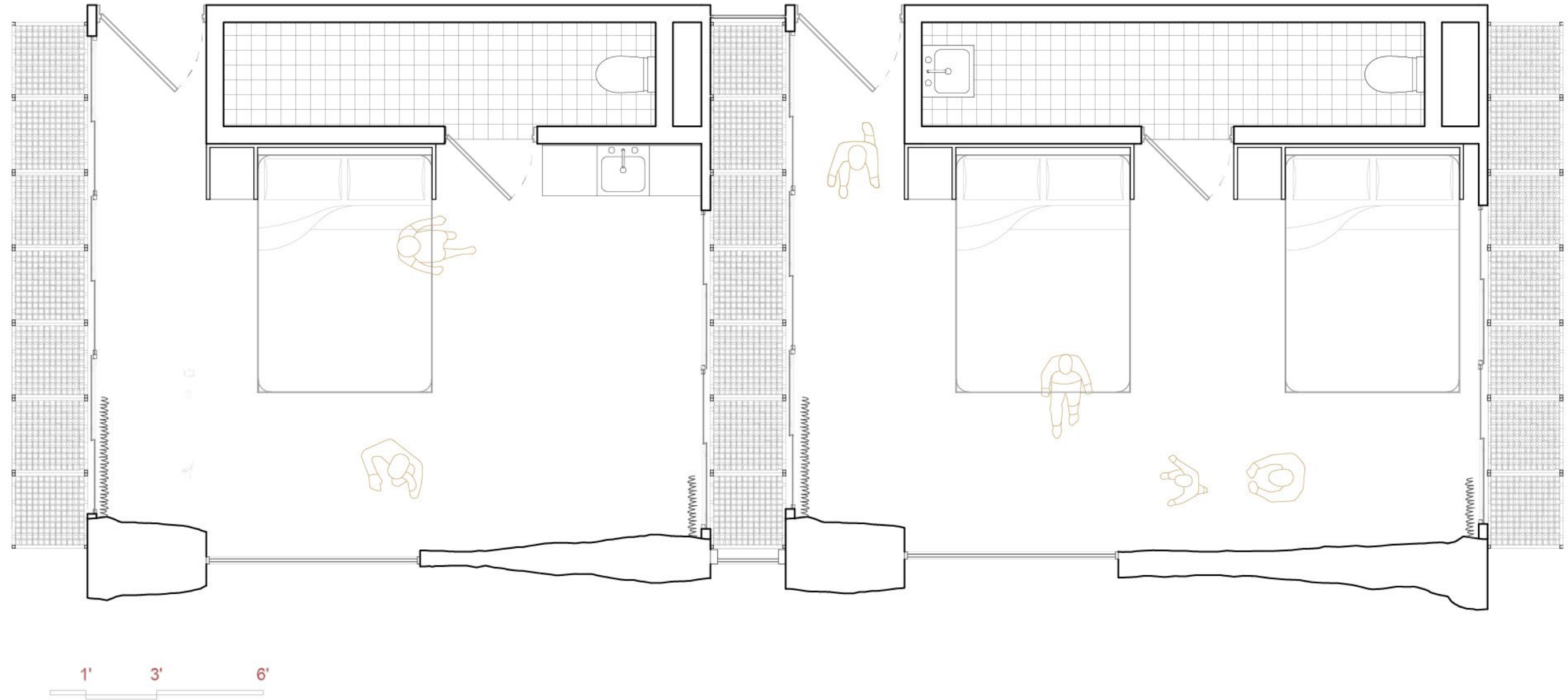

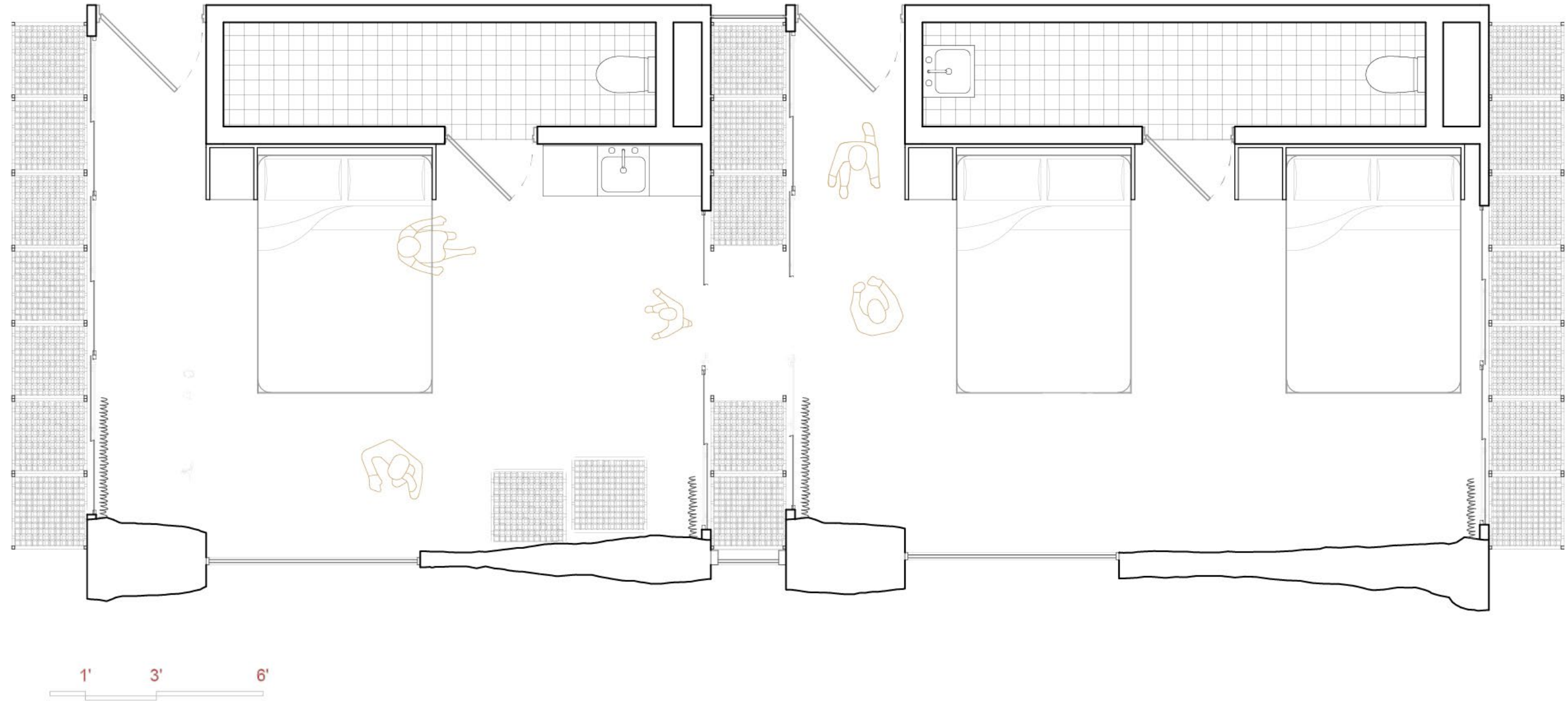

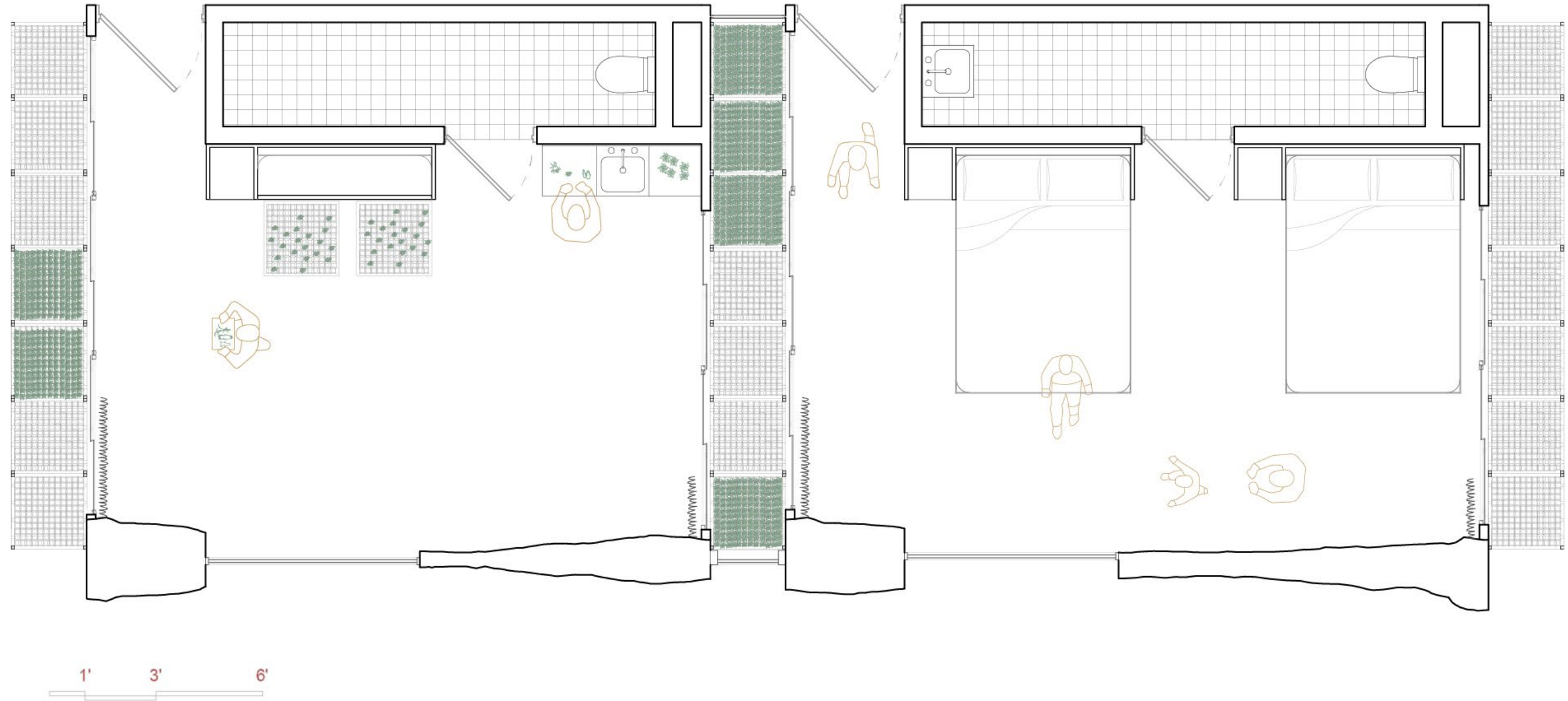

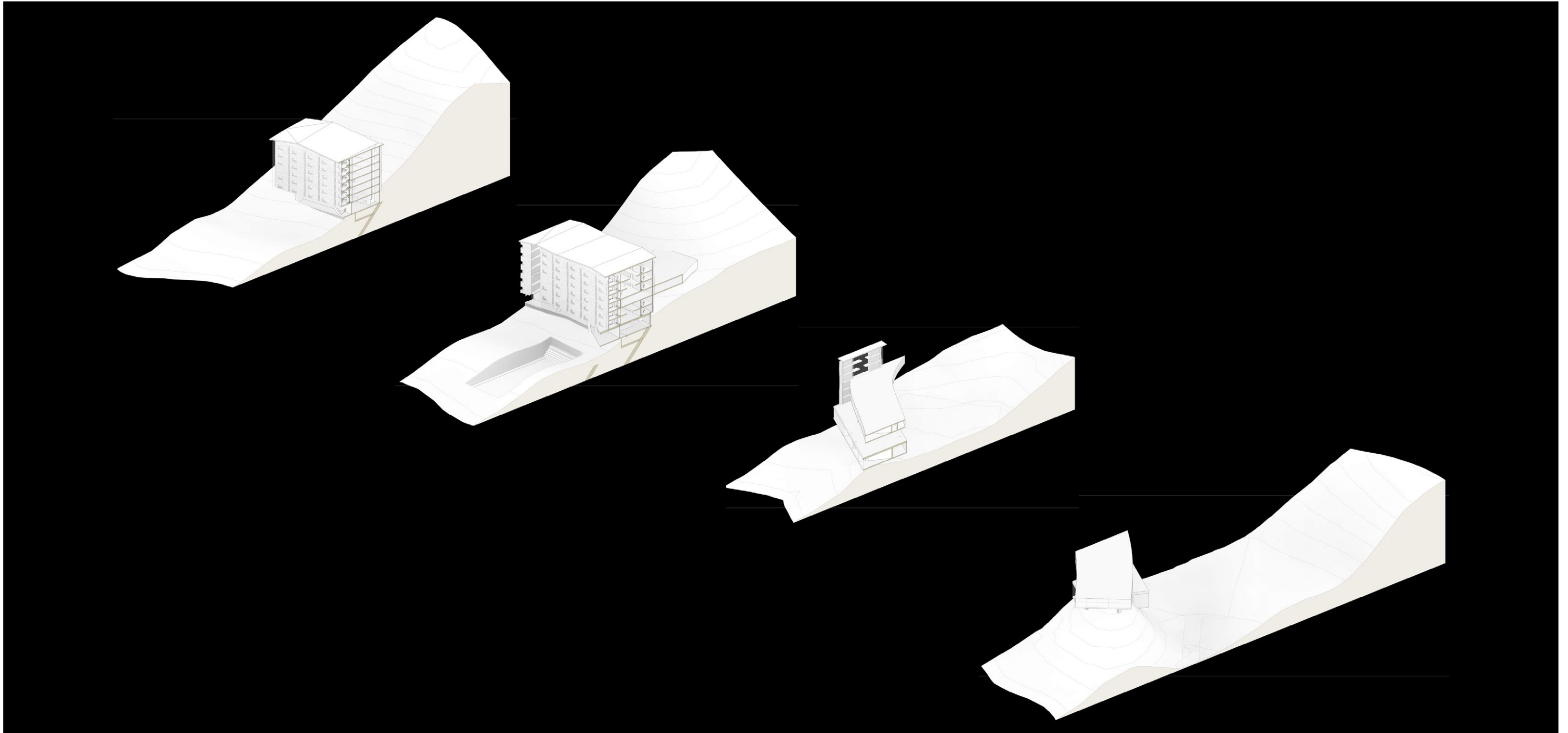

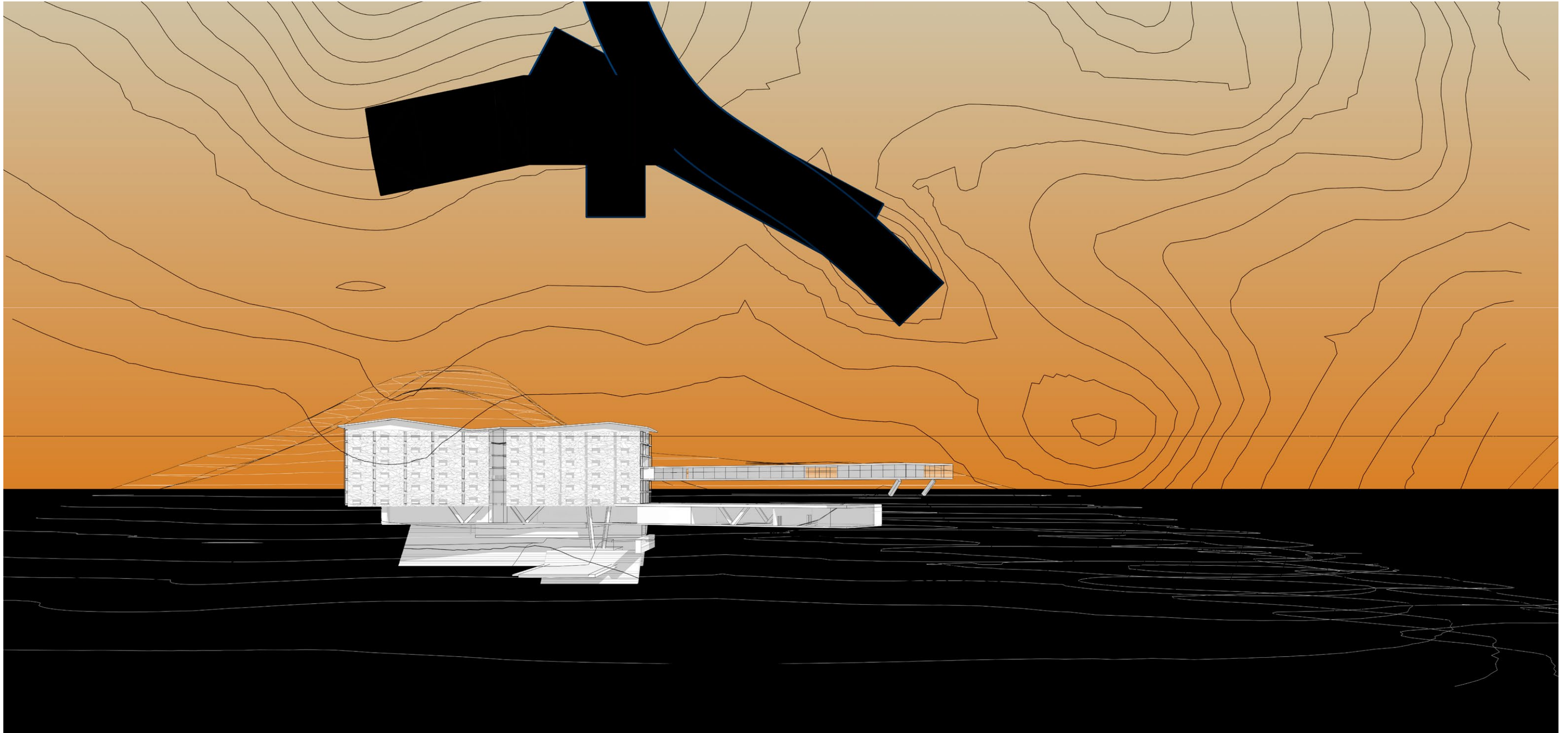

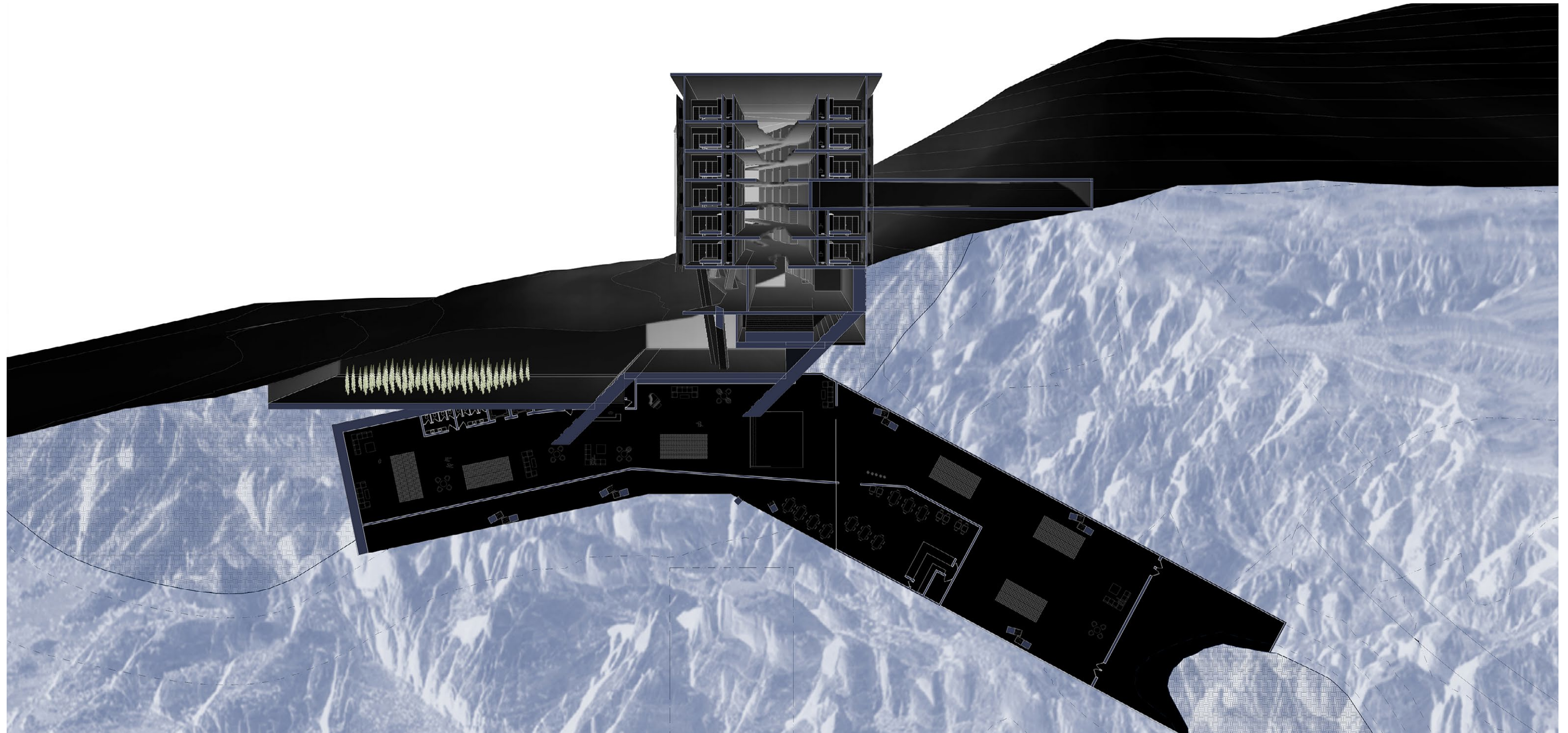

05 FALLEN DUST

ULTRAREAL TECH

LOCATION:	MUT, EGYPT
TYPE:	LIBRARY
DATE:	FALL, 2021
INSTRUCTOR:	PHILLIP CRUPI JOSEPH BRENNAN



