

Oswaldo Delbrey
GSAPP 2019–22

5	Uncanny Storytellers Core I, Prof. Jaffer Kolb 2019
21	Model Diagram ADR I 2019
36	School for the Commuter Nation Core II, Prof. Christoph Kumpusch 2020
36	Housing Core III, Prof. Mario Gooden 2020
39	Fringe Timber Advanced I, Prof. Lindsey Wikström 2021
57	Ecosystems of Dissent Advanced II, Prof. Andrés Jaque 2021
98	Towel Bathhouse Ultrareal 2022
101	Makergraph Advanced III, Profs. Ada Tolla & Giuseppe Lignano 2022

1. UNCANNY STORYTELLERS

Uncanny Storytellers examines the life of “stuff,” exploring how they perform domesticity throughout the city and how they gain value as they are displayed to the public.

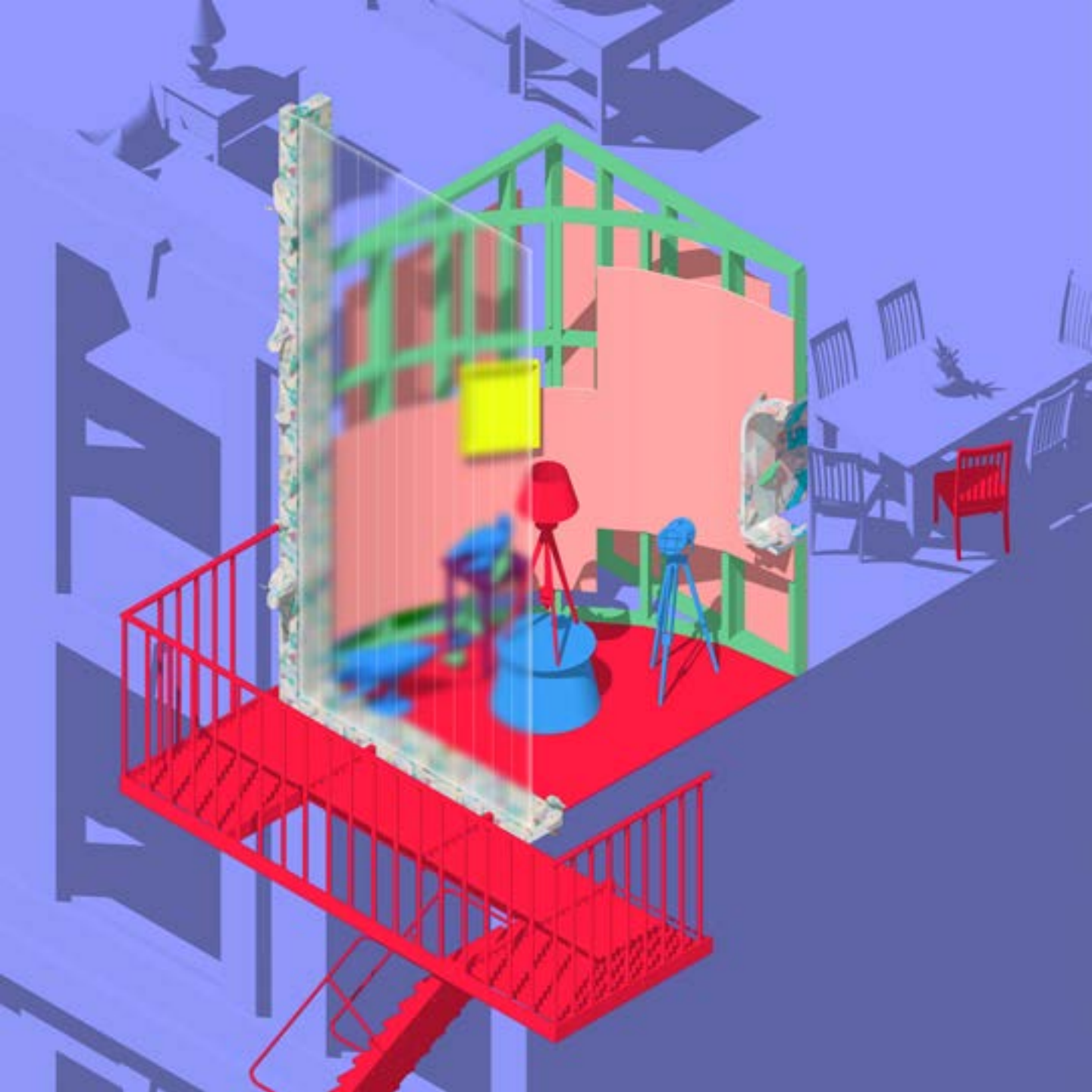

On a portion of Broadway between 150th St. and 184th St. residents of Washington Heights drag their furniture out to the sidewalk and engage with the neighborhood in a very domestic manner. An exhibition/storage space allows residents to keep their unused stuff in circulation by displaying, curating and exchanging parts of their own domestic collection using the window as an architectural mediator between the stuff and the people. Once the stuff becomes unusable, it gets incorporated into the architecture as material for the window frames themselves.

Axon-section of display space and fire escape.

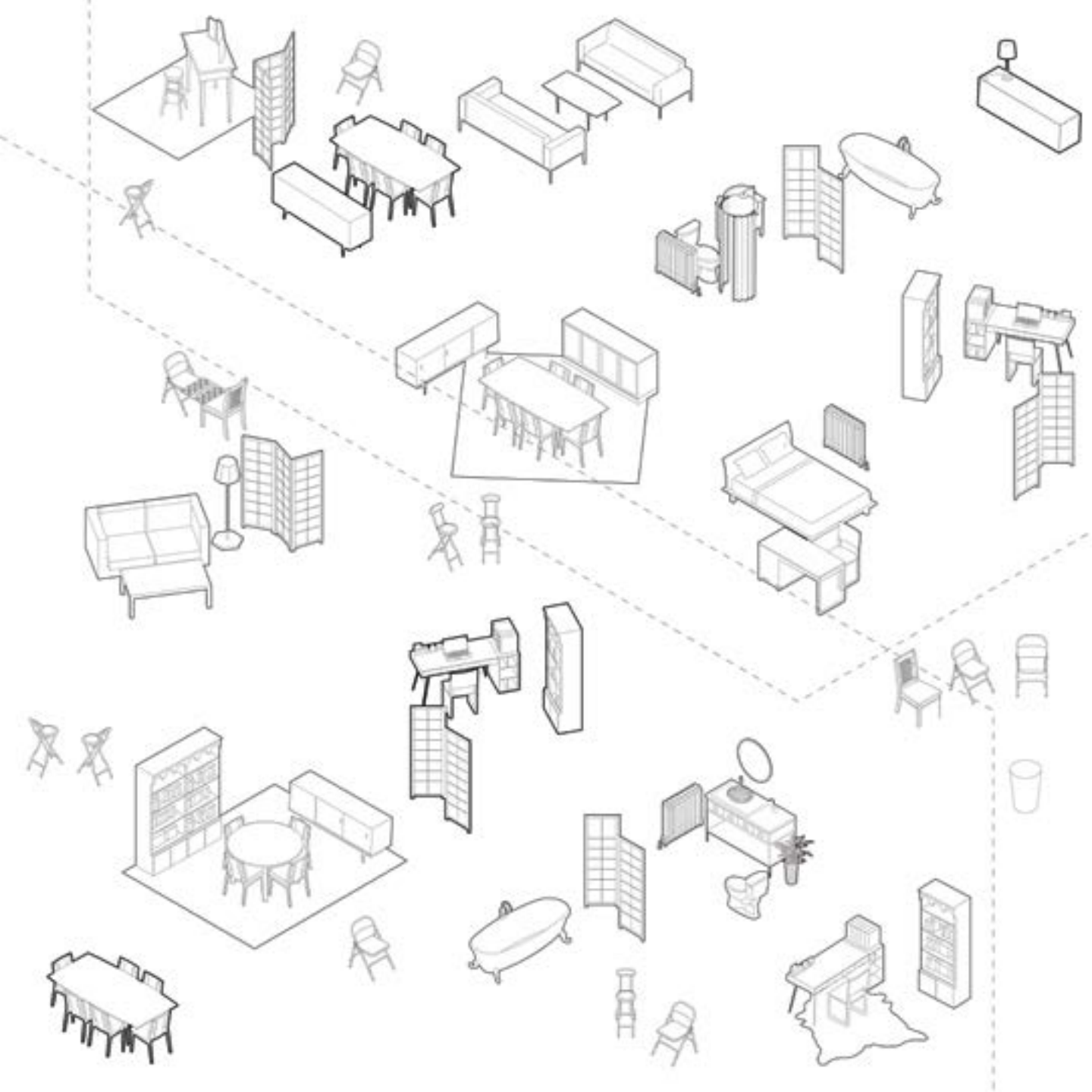

Ghosted building, street and domestic furniture arrangements become part of one field.

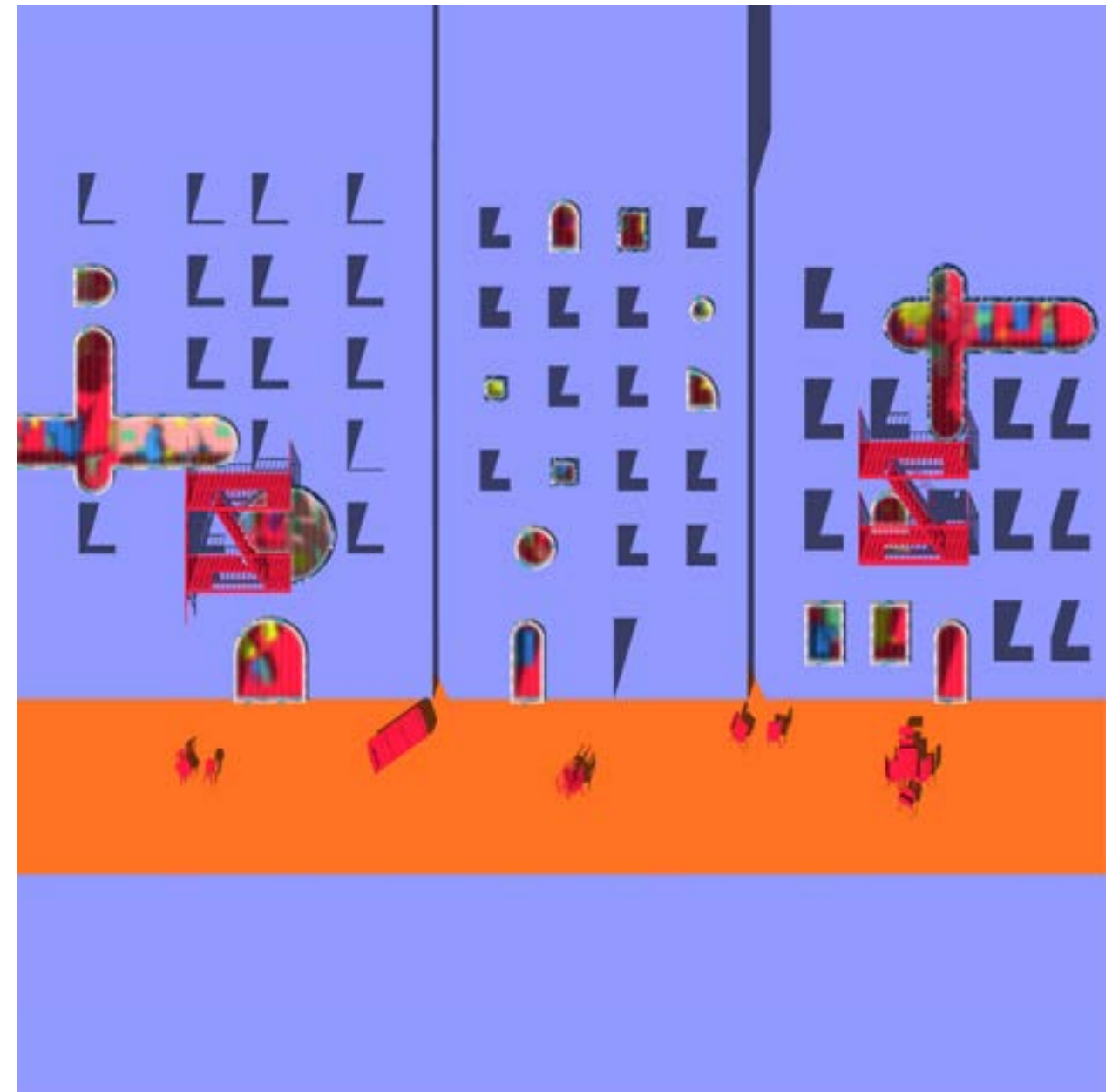

Oblique axon view. Display corridor weaving behind façade and onto the street.

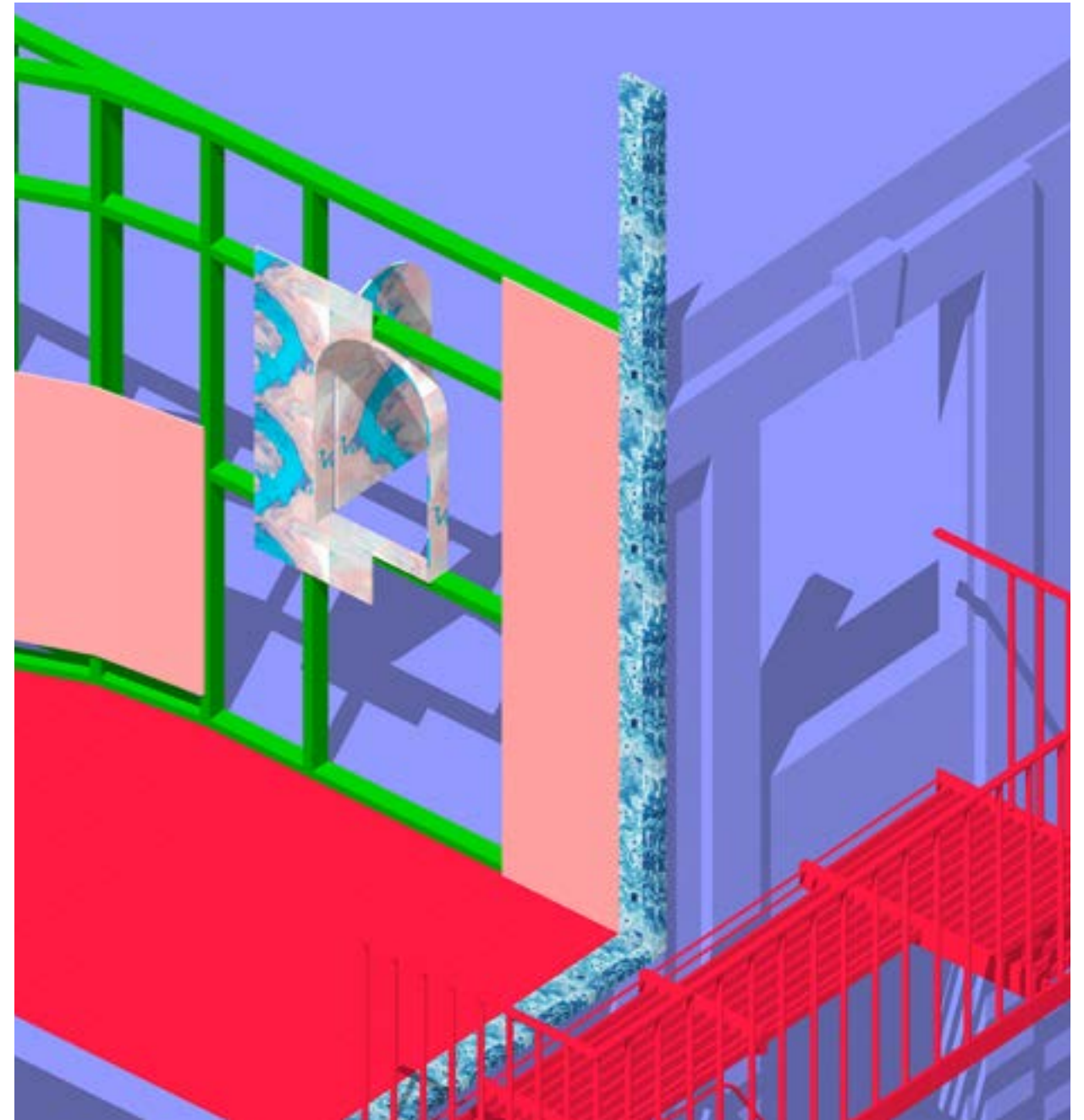
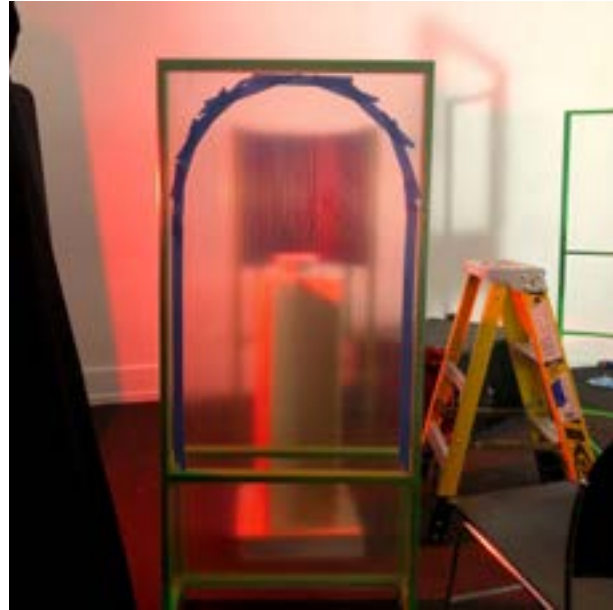

1:1 Installation of display corridor frames.



Display-to-apartment window frame.

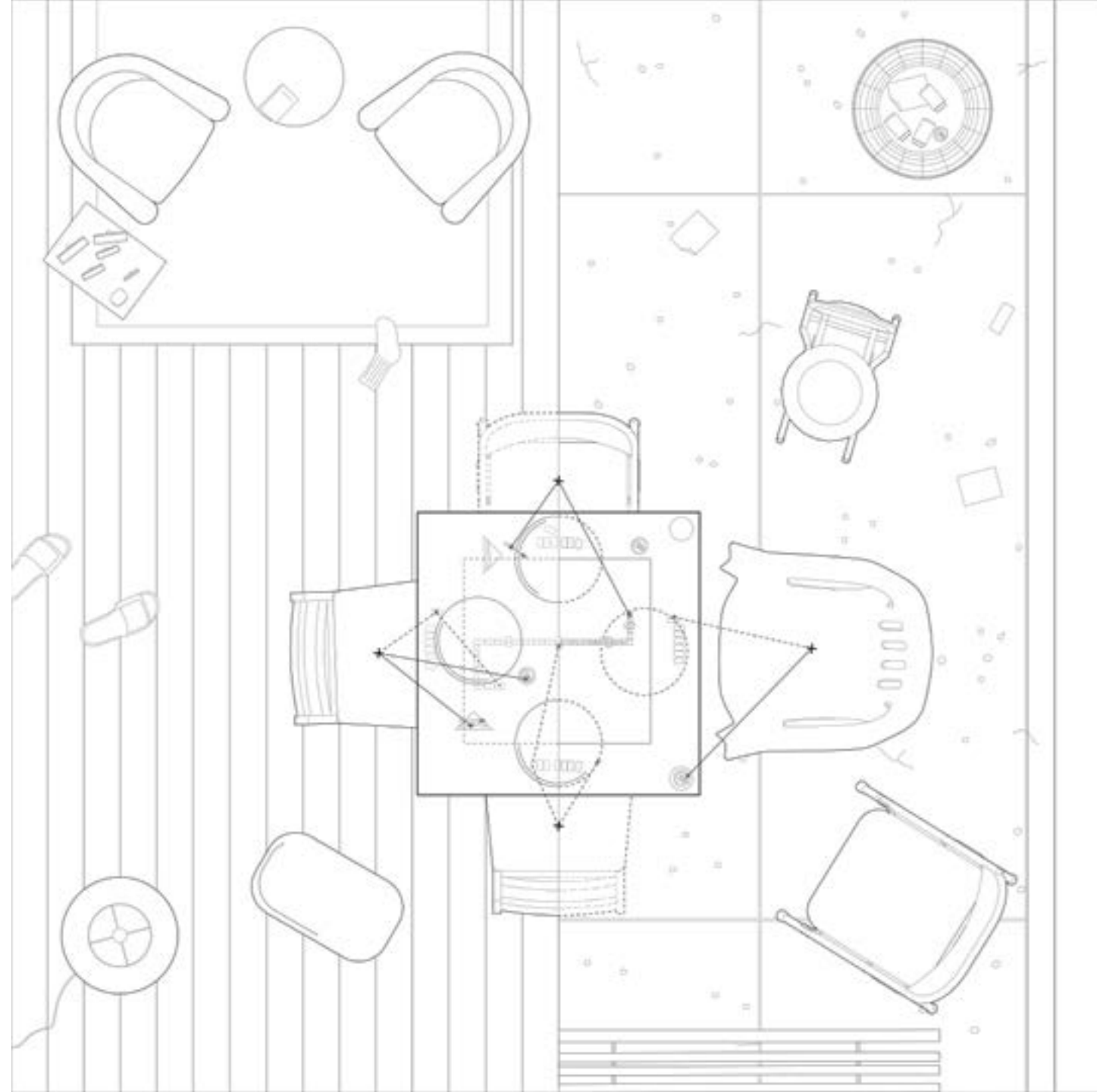

Domestic vs public furniture arrangements



Posters and signs display seen from the outside façade frame.

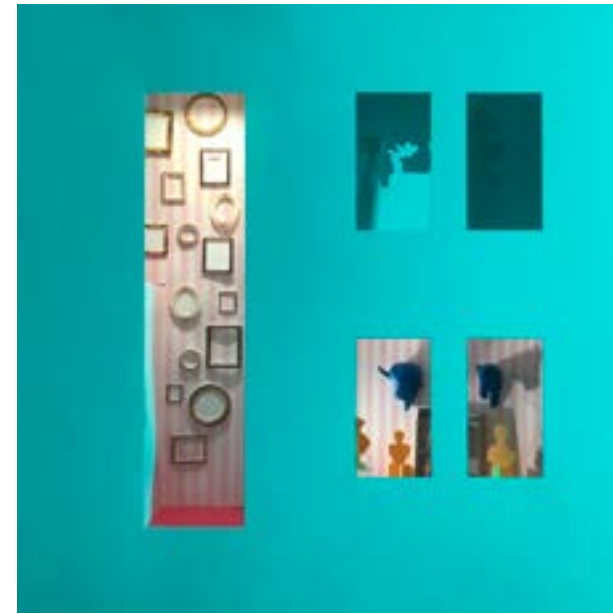

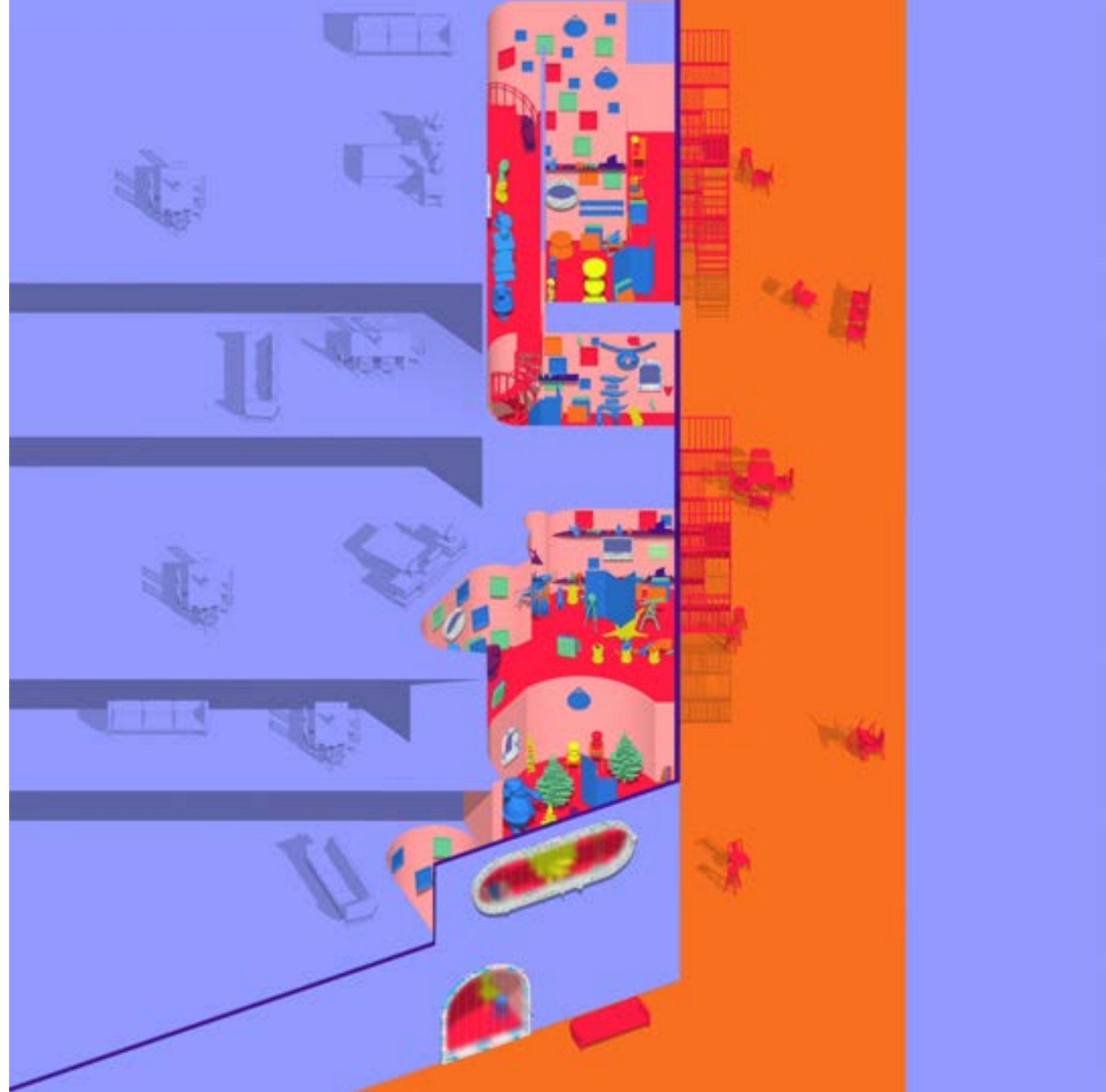

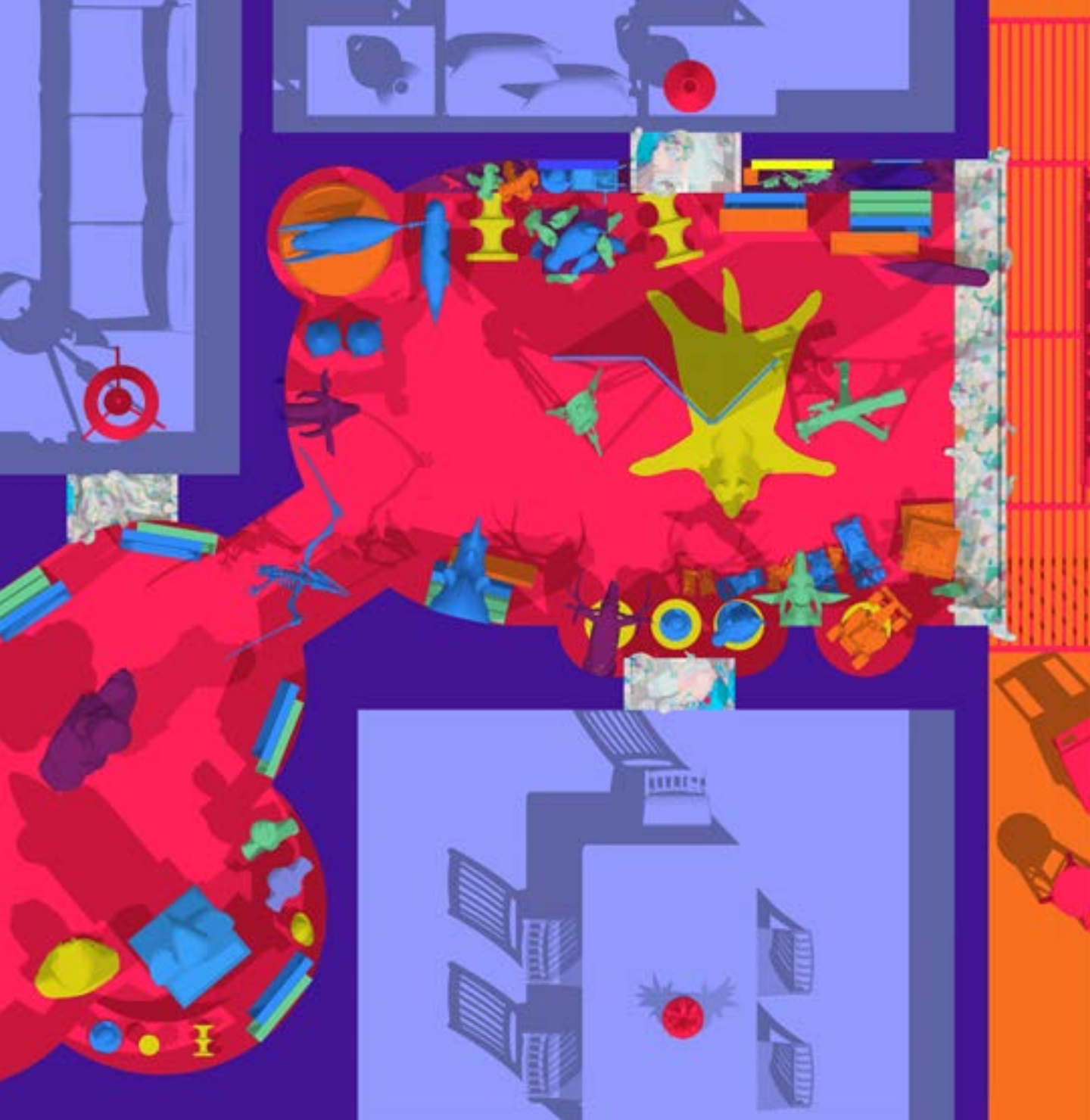

Apartments have access to the corridor where they can add of take to and from the display.

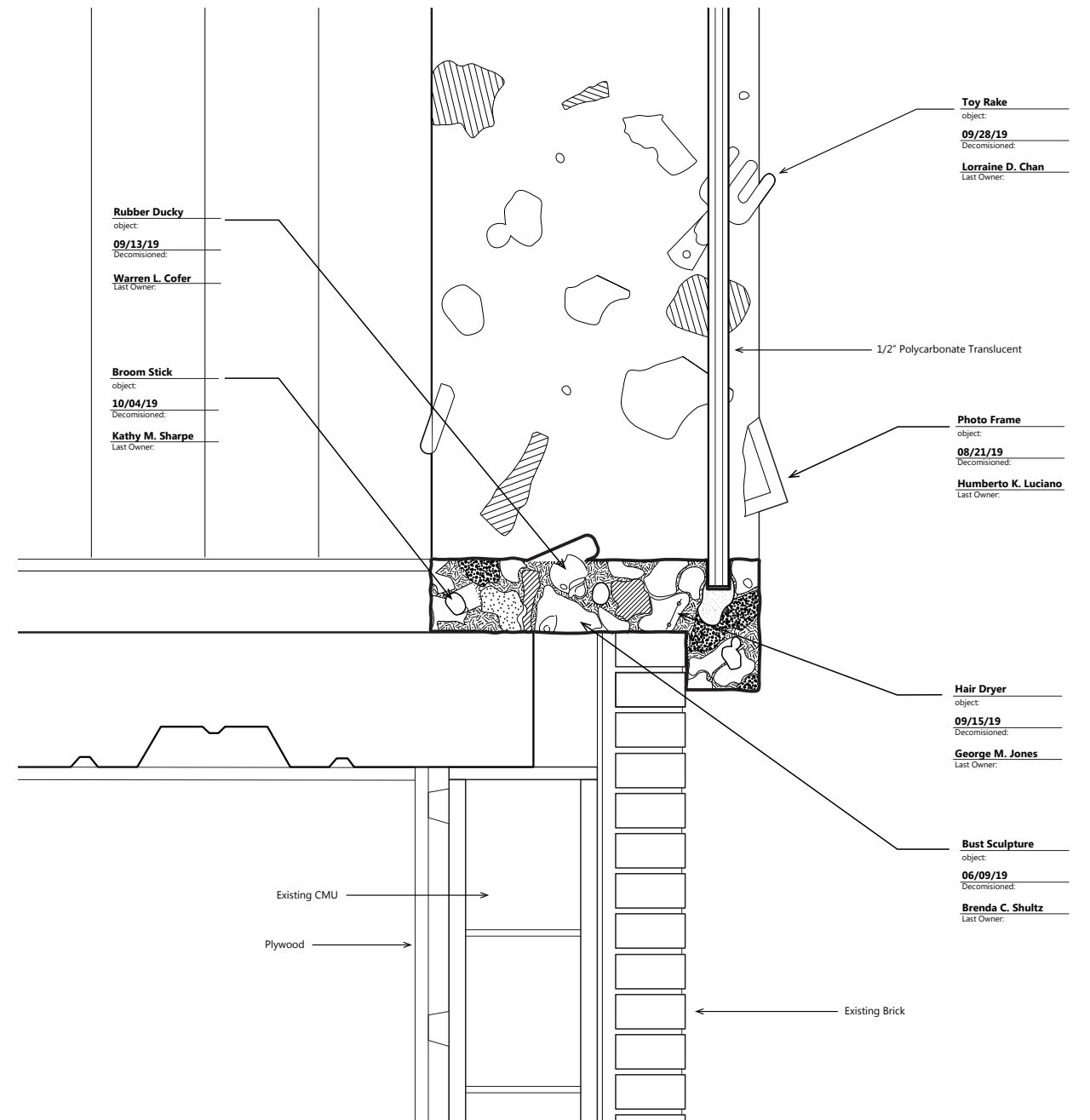

The End

2. SCHOOL FOR THE COMMUTER NATION

The School for the Commuter Nation questions the traditional spaces and experiences that are admitted into the school program to address issues of American colonialism affecting Puerto Rican cultural and politica agency.

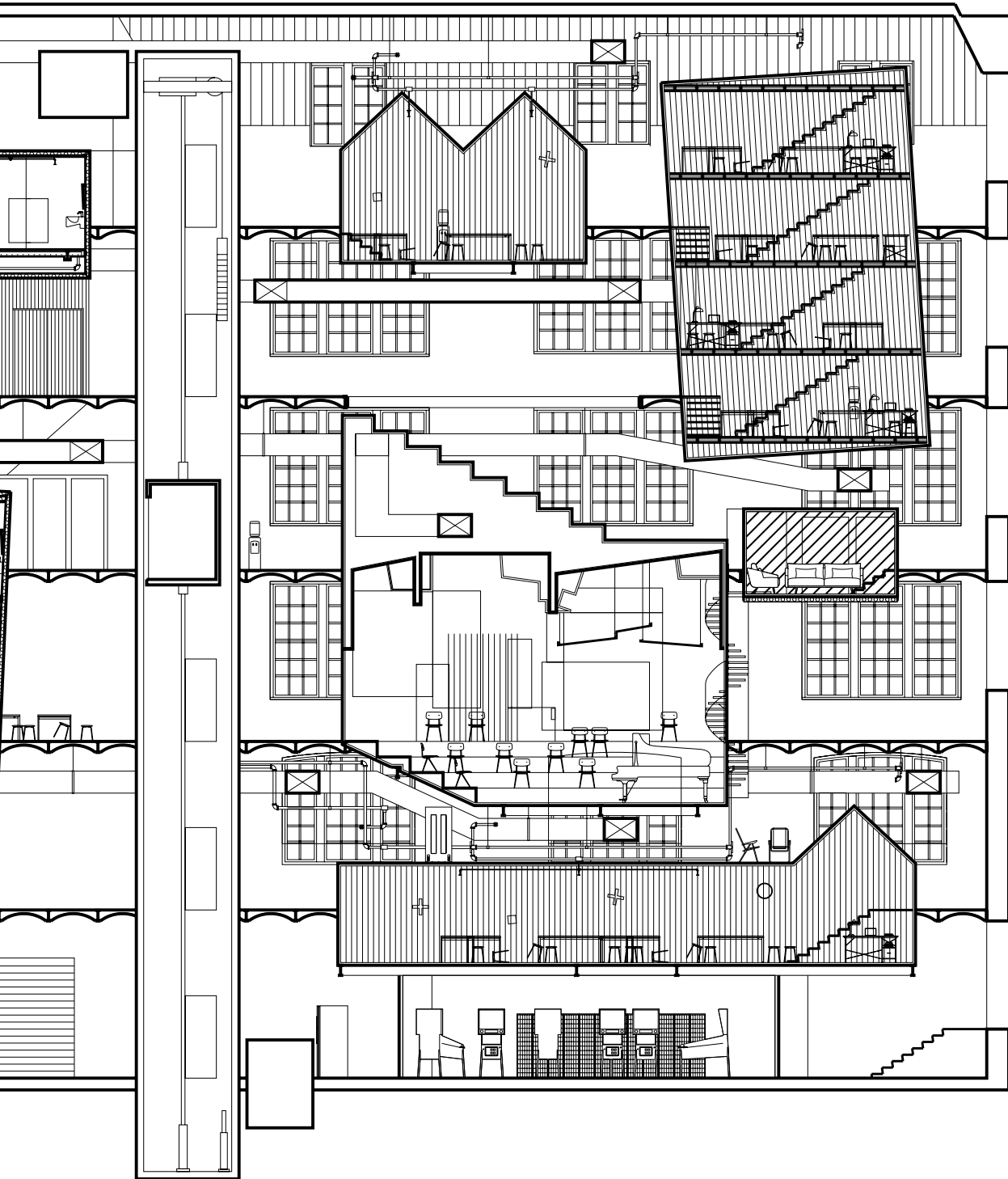

Section of the northeast wing of the school.

From a critical look into migration patterns of the Puerto Rican people over recent years, the School for the Commuter Nation questions the traditional spaces and experiences that are admitted into the school program to address issues of American colonialism affecting Puerto Rican cultural and political agency. By incorporating mundane and even frowned upon activities of the Puerto Rican community, it attempts to generate a sanctuary space for their identity to exist outside of the American cultural 'policing' in hopes that it will feed into the education and sense of self of new generations.

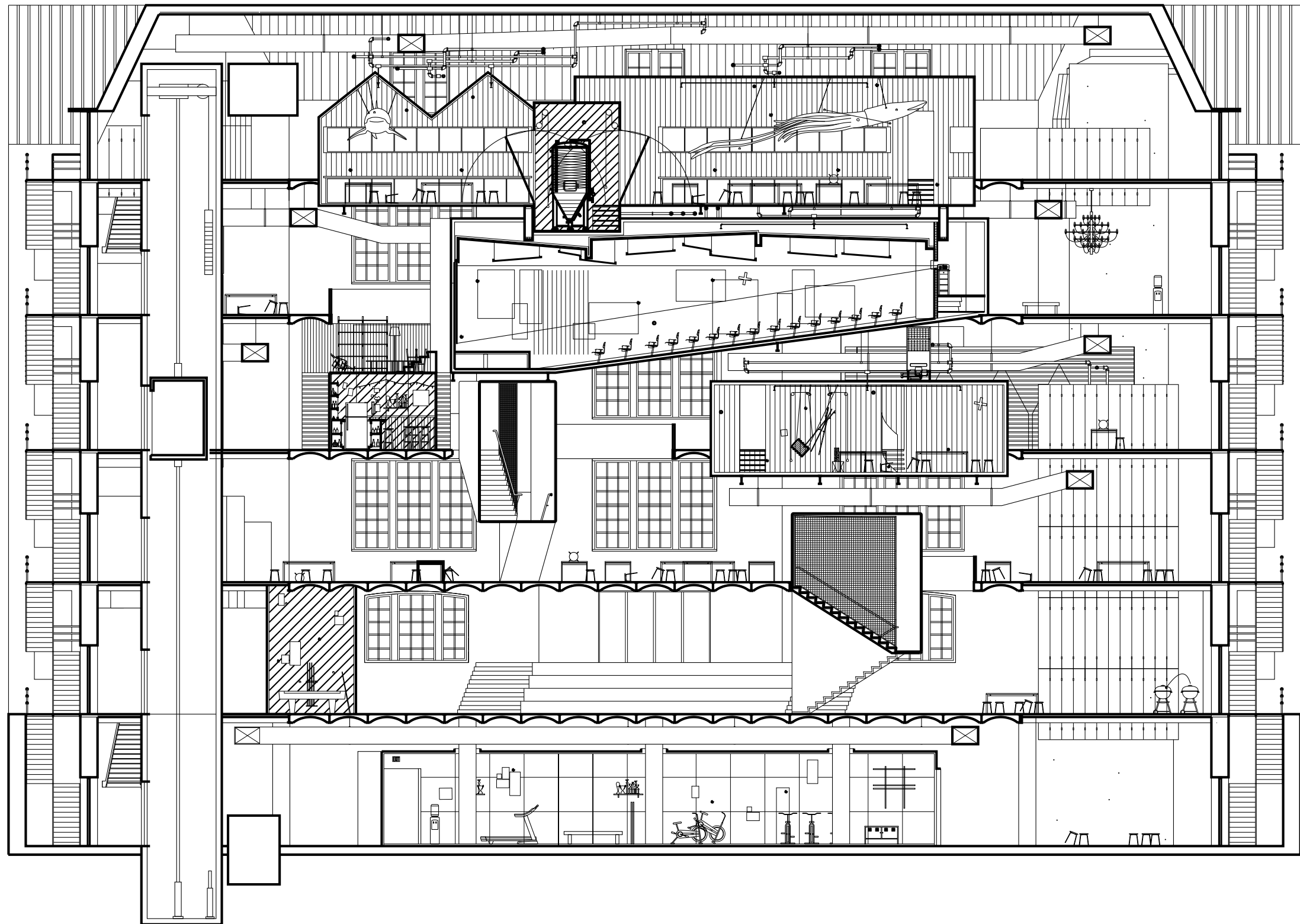

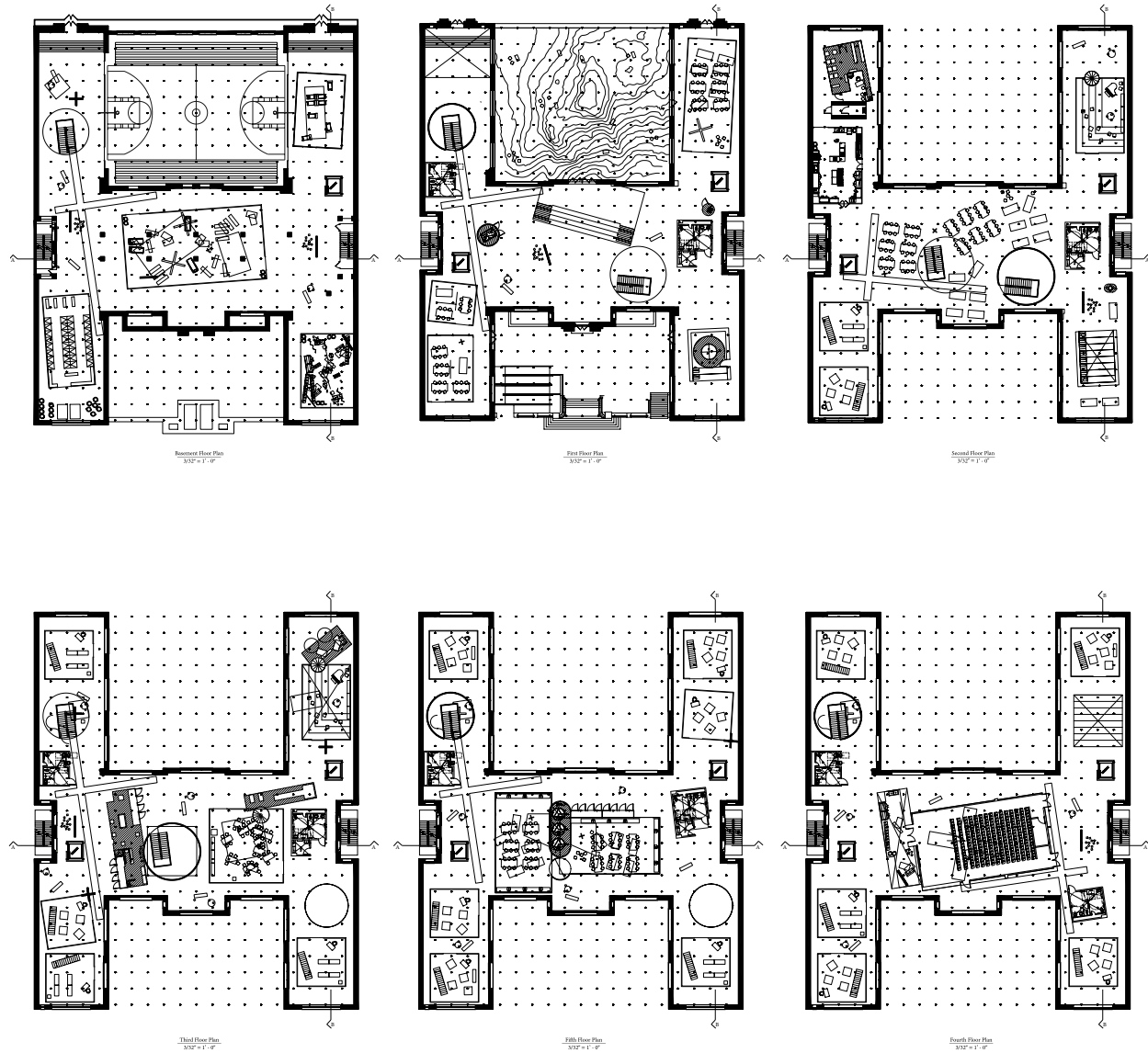

The school negotiates its encounters between the two programs through common spaces and schedule overlaps in order to establish what will be accessible, and at what time, to the students or to visitors of the enclaves. The enclaves occupy 18 interstitial spaces and generate new residual spaces that are sometimes used for utilities or buffer between the two, and sometimes serve as the link giving away what is between the walls. The traces of both programs' users are picked up by the users of the other, constantly generating dialog of the two lives of the building.

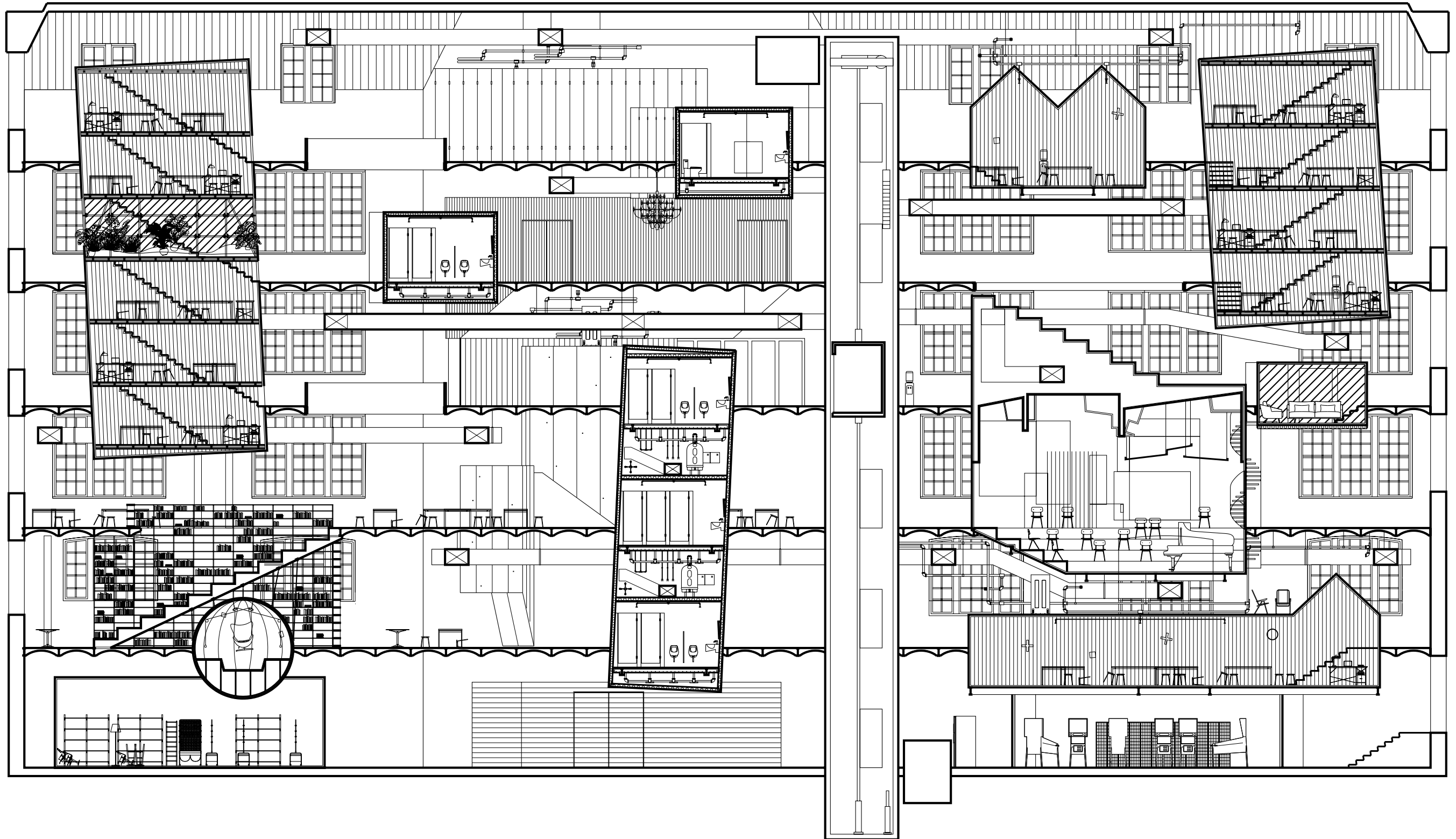

B. North-South section.

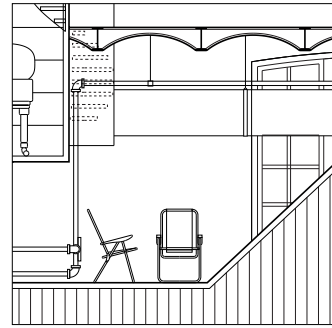

B
Interstitial Roof Space

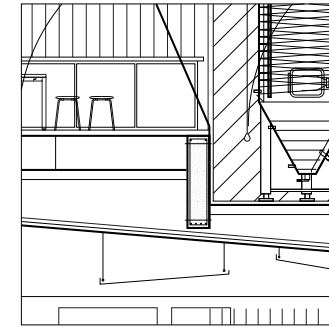

E
Converging Point

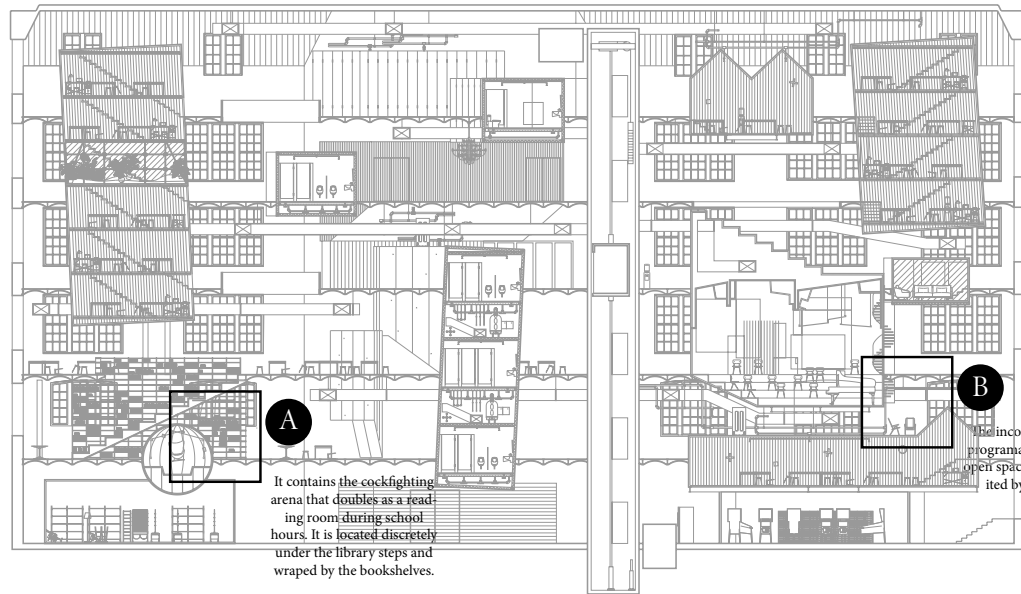

A
It contains the cockfighting arena that doubles as a reading room during school hours. It is located discretely under the library steps and wrapped by the bookshelves.

B
The inconsistencies between programmatic volumes provide open spaces that can be inhabited by the community.

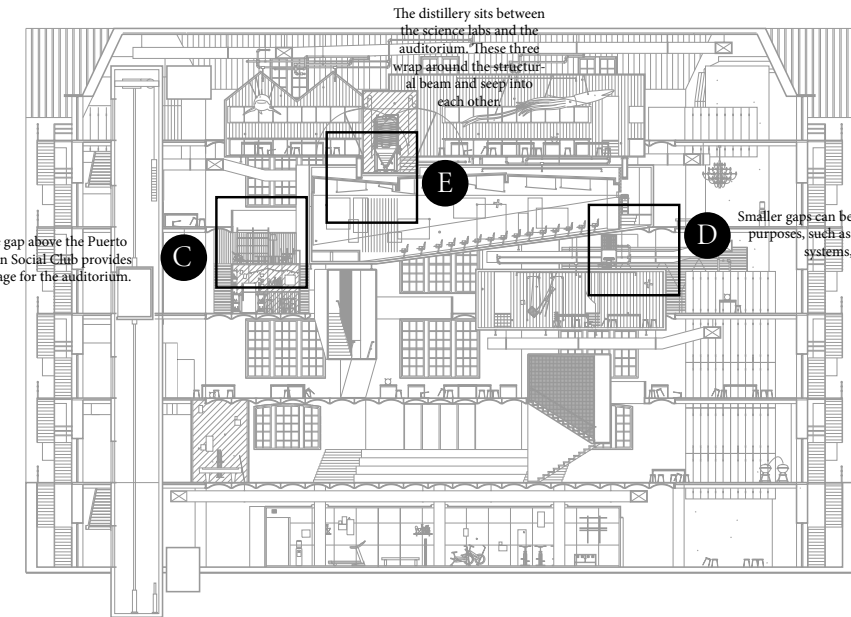

C
The gap above the Puerto Rican Social Club provides storage for the auditorium.

The distillery sits between the science labs and the auditorium. These three wrap around the structural beam and seep into each other.

D
Smaller gaps can be used for mechanical purposes, such as A/C units, electrical systems, and pipes.

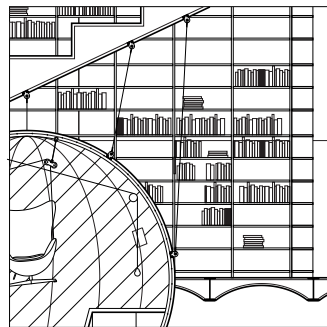

A
The Reading Nook

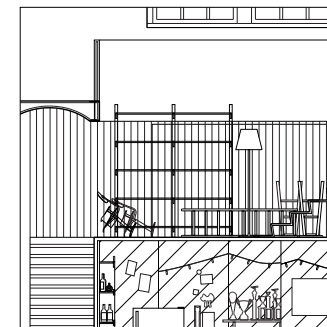

C
Auditorium Storage

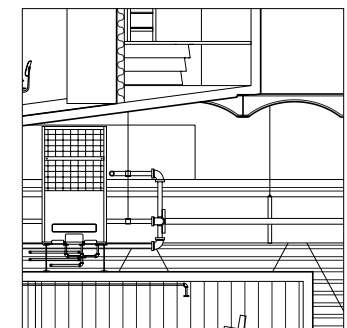

D
Mechanical Gaps

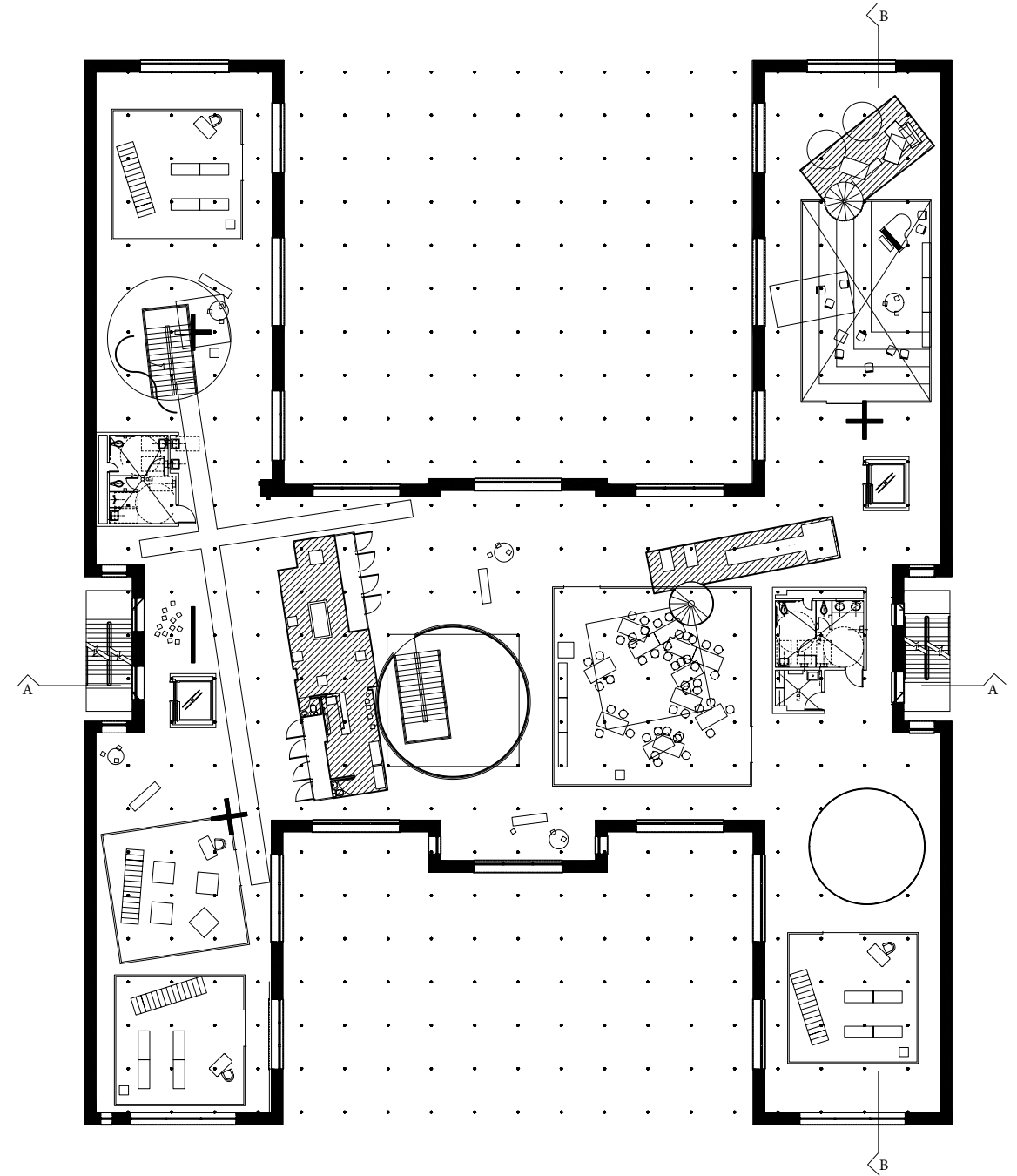
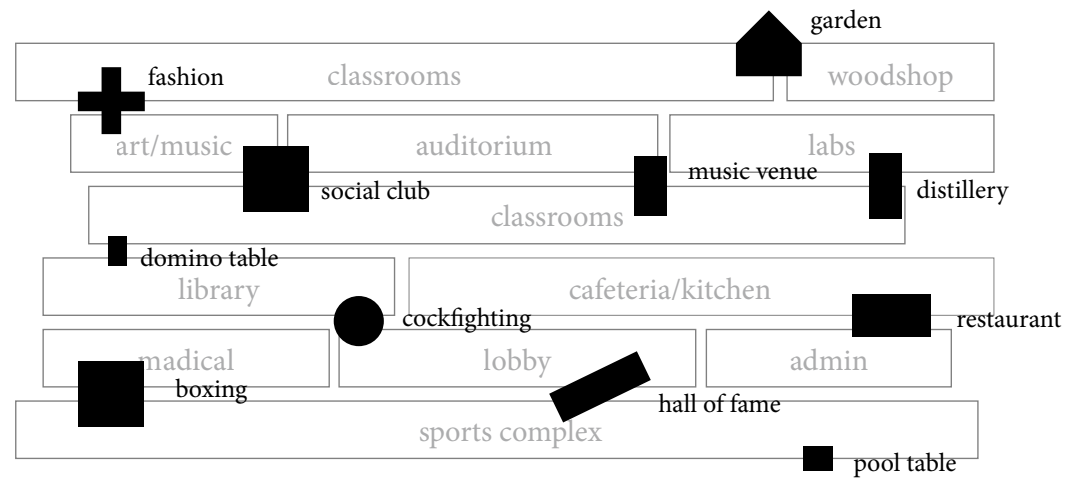

Third Floor Plan
3/32" = 1' - 0"

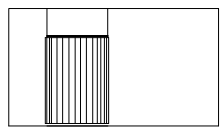
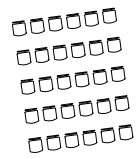
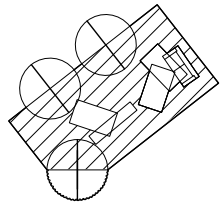
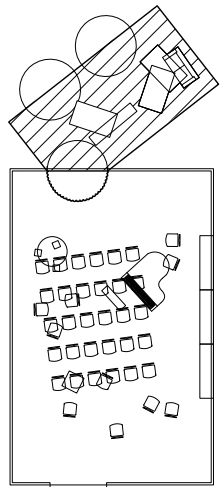

Music Venue

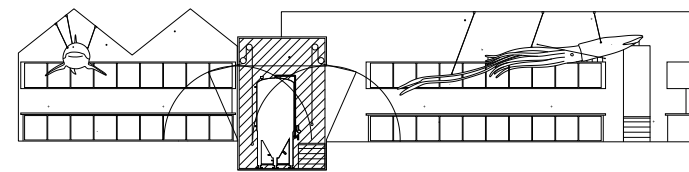
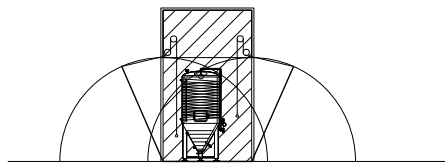
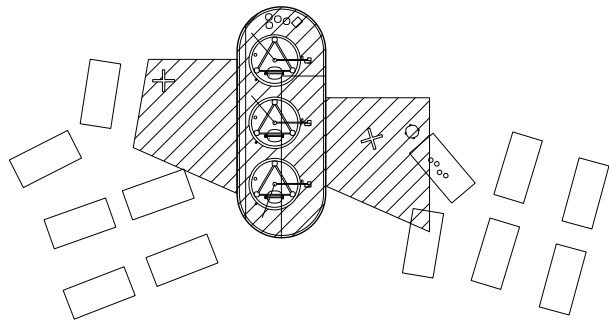
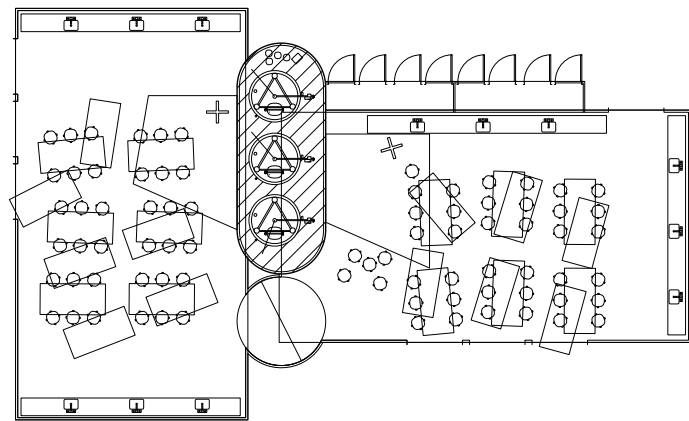

Pitorro Distillery

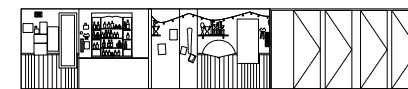
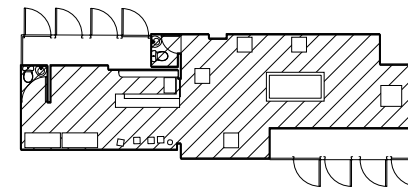
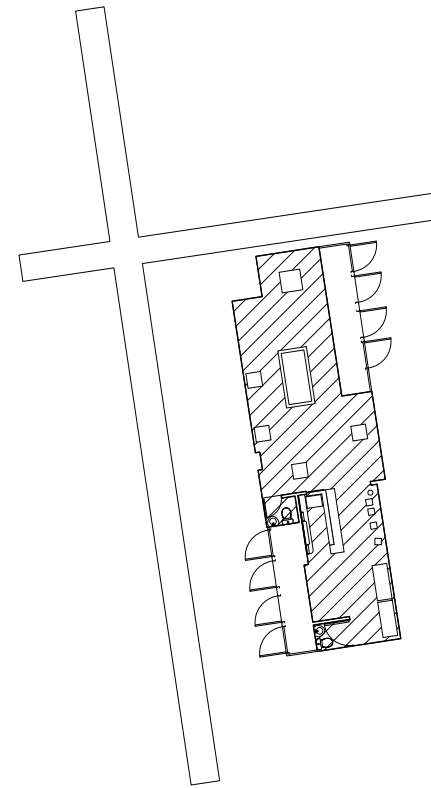

Puerto Rican Social Club

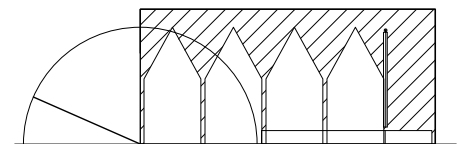
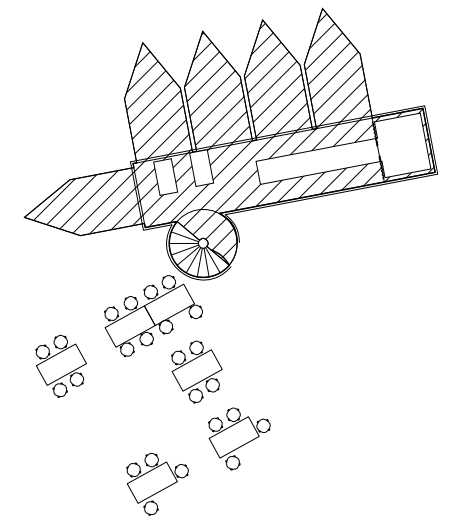
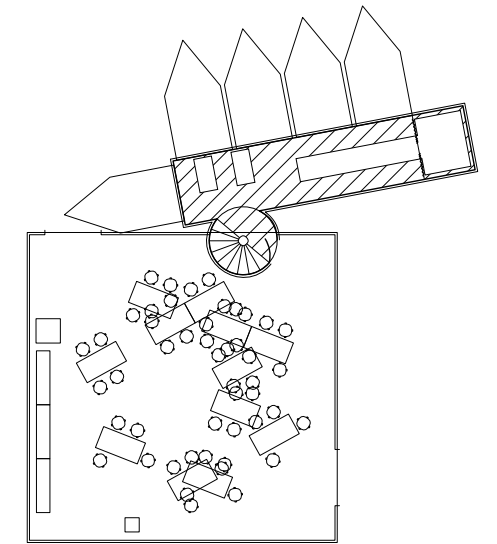

Fashion Studio

Sherefudin's White Mosque

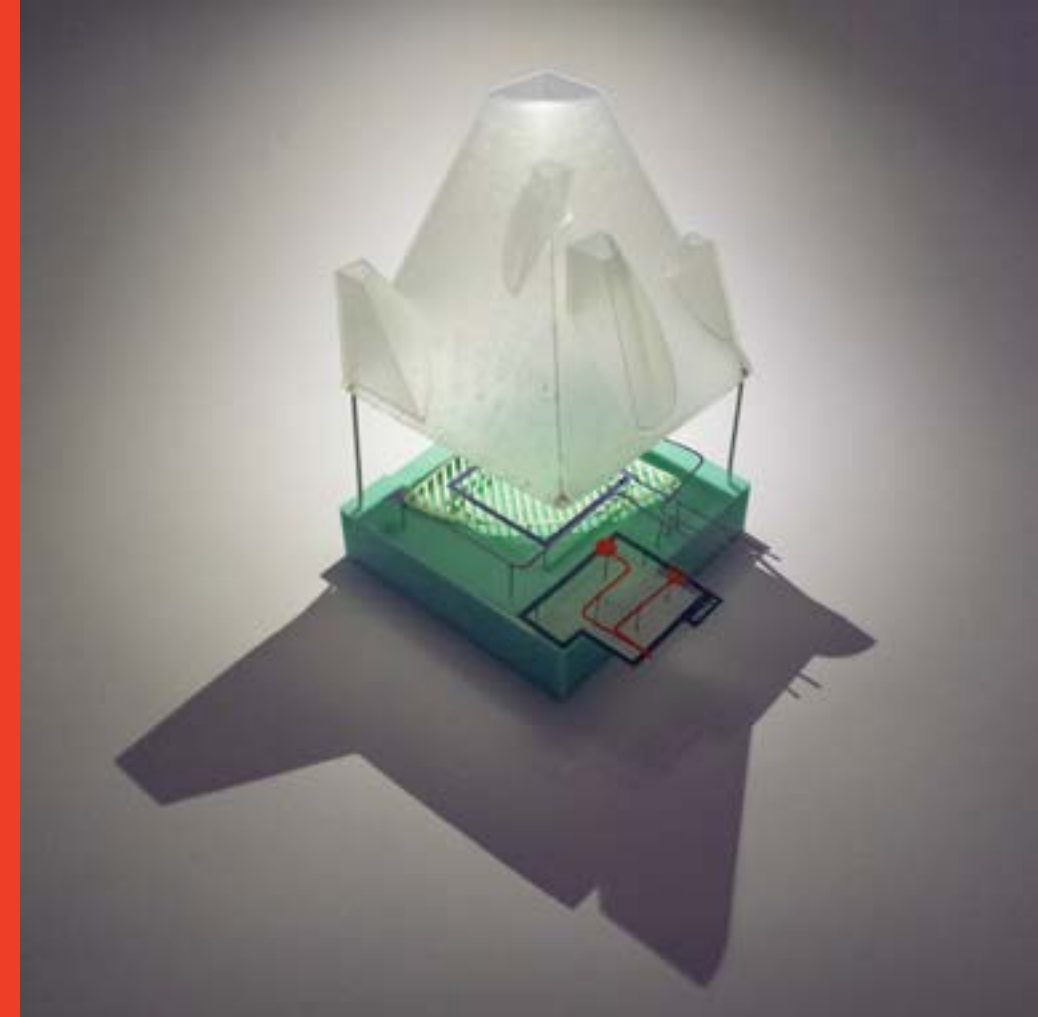

This diagram model explores the spacial and programatic rituals that take place inside the payer room of this Serbian mosque. Despite it's separate entrance for men and women, this mosque allows women to inhabit the prayer space with the men through the adition of and anex room.

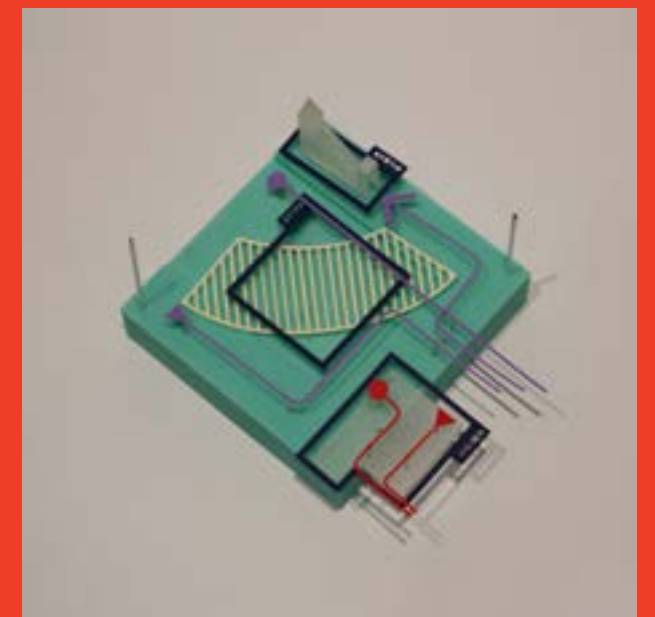
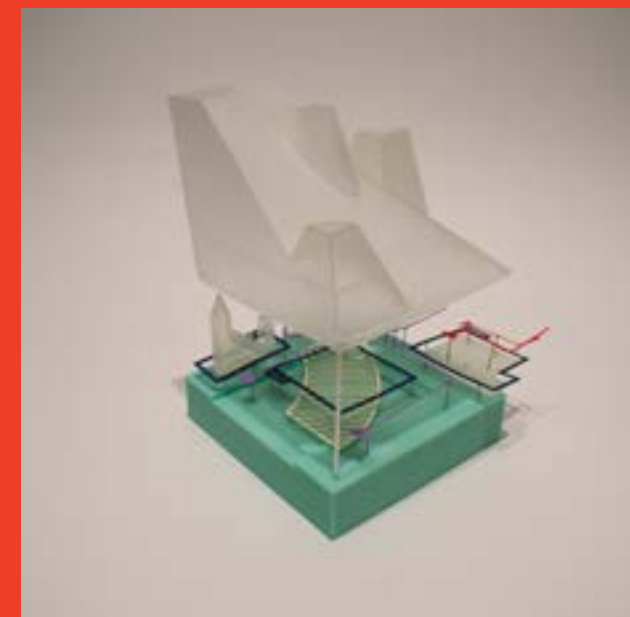

3. HOUSING

Inhabiting the Grey imbricates the presence of the unseen/unacknowledged/unrepresented, Modernism's non-ideal subject, in space and time.



VGN.9

Inhabiting the Grey imbricates the presence of the unseen/unacknowledged/unrepresented, Modernism's non-ideal subject, in space and time.

Modernism's ideal universal subject, the white male, claims the power to see and not be seen, to represent while escaping representation in space and time. The gaze of "The unmarked positions of Man and White" (The Persistence of Vision, Donna Haraway) frames and marks the body of all non Man and White, creating a sense of hyperawareness/estrangement.

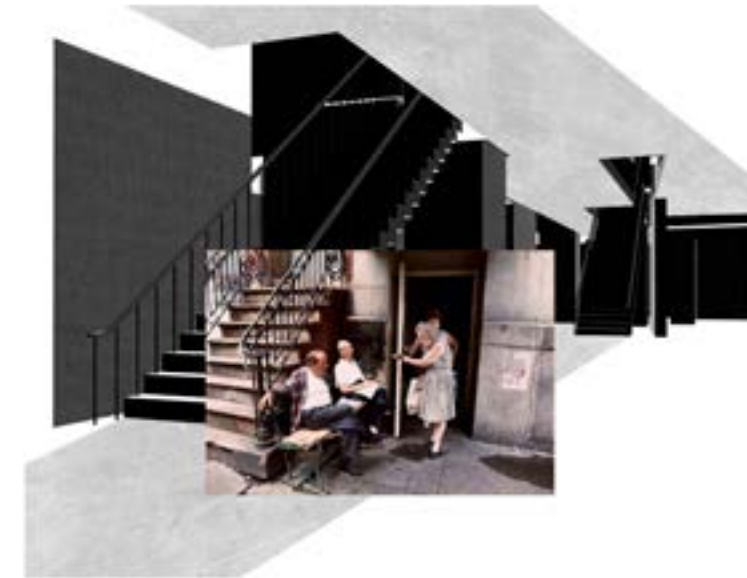



01/01



01/02



01/03



01/04



01/05



01/06



01/07



01/08

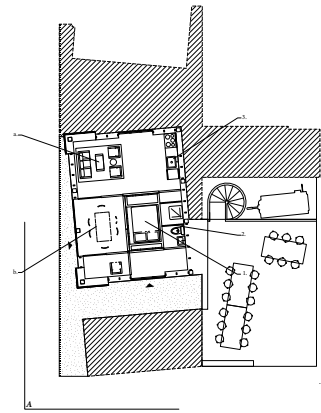

One Sleeping Space
118' - 1' 0"

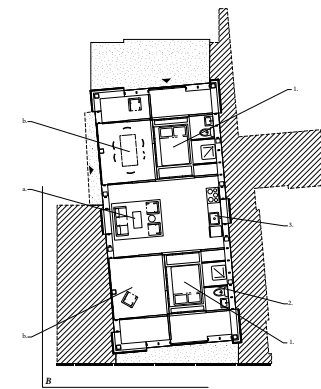

Two Sleeping Space
118' - 1' 0"

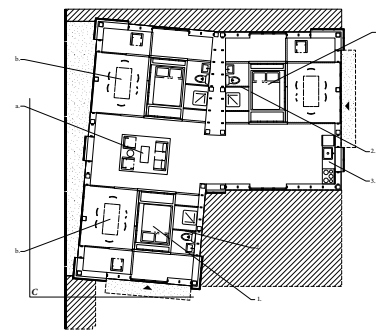

Three Sleeping Space
118' - 1' 0"



The White Man's Gaze frames the daily rituals of work, rest, and leisure into a conventional time frame revolving around the 9-5 work schedule. This datum in time programs spaces to function at specific moments excluding anyone outside of this time frame.

There are moments of overlap in space and time between the presence of the marked and unmarked bodies, a gray space, an in between, a buffer.

Imbricating the presence of the marked bodies in this gray space recognizes, without displaying, the marginalized, creating a space to practice liberty, a space of liberation.



- | | | |
|---------------------|--------------------|---------------------|
| 1. Vendor Space | 6. Baths | A. 1 Sleeping Space |
| 2. Vendor Storage | 7. Laundry | B. 2 Sleeping Space |
| 3. Communal Kitchen | 8. Charging Parlor | C. 3 Sleeping Space |
| 4. Canteen | 9. Arcade | |
| 5. Garden | 10. Ballroom | |

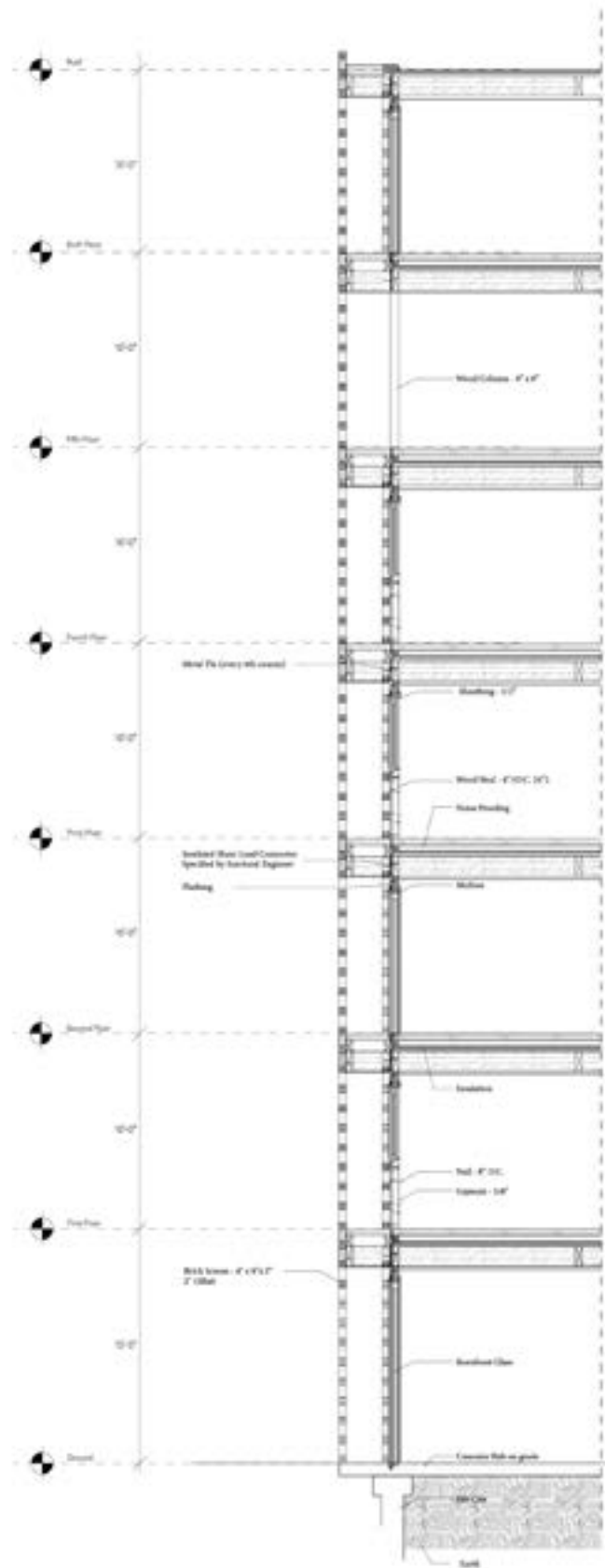

MAN 1



- 1. Member Space
- 2. Member Storage
- 3. Commercial Kitchen
- 4. Corridor
- 5. Garden
- 6. Hall
- 7. Laundry
- 8. Changing Parlor
- 9. Arcade
- 10. Auditorium
- 11. Sleeping Space
- 12. Sleeping Space
- 13. Sleeping Space

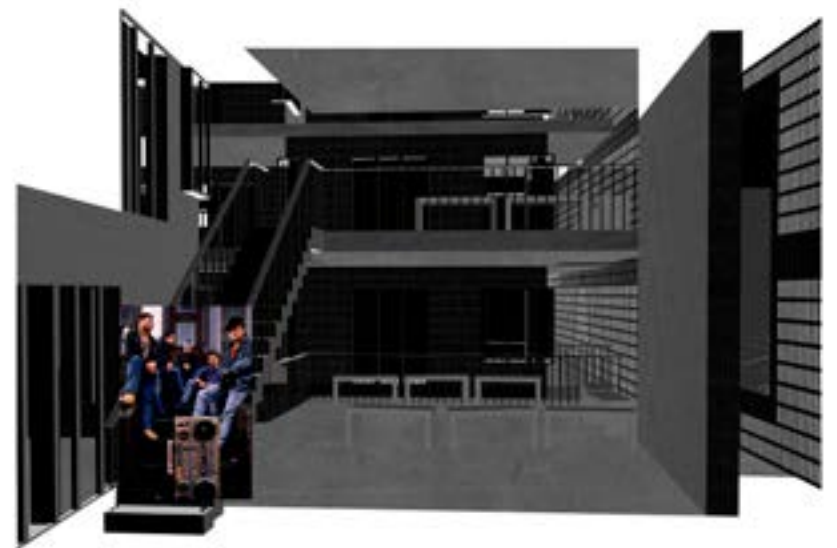



4.

FRINGE TIMBER

The project proposes a CLT tower against the 400 ft tall quarry wall that will serve as the headquarters for the site's rehabilitation operations, and site planning for the site to grow around it.



What remains of Tahawus today are ruins. What was once a major iron mining town in New York, and later an important source of titanium for the US during the Second World War is now an old ghost-town tourist attraction. That is for the old buildings and mining infrastructure, but the soil has been forever altered in such a way that it will never be the same again, and millennia after today people will still observe the scars left by the extraction that once took place here. Two massive quarry lakes and a 400 ft tall quarry wall break the landscape abruptly with more than 900 acres of rubble surrounding them. These scars will remain as monuments to our ability to alter our landscape, for better or worse.

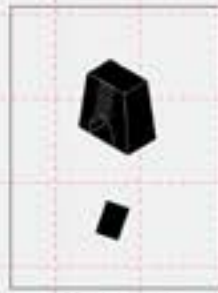

old mining ruin



preserved tailing garden



pavilion

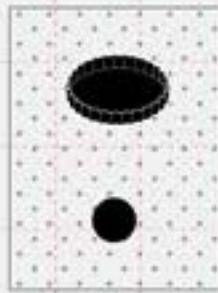

amphitheatre

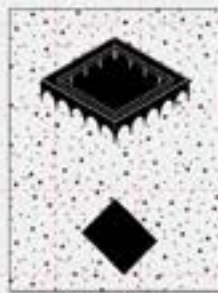

botanical garden

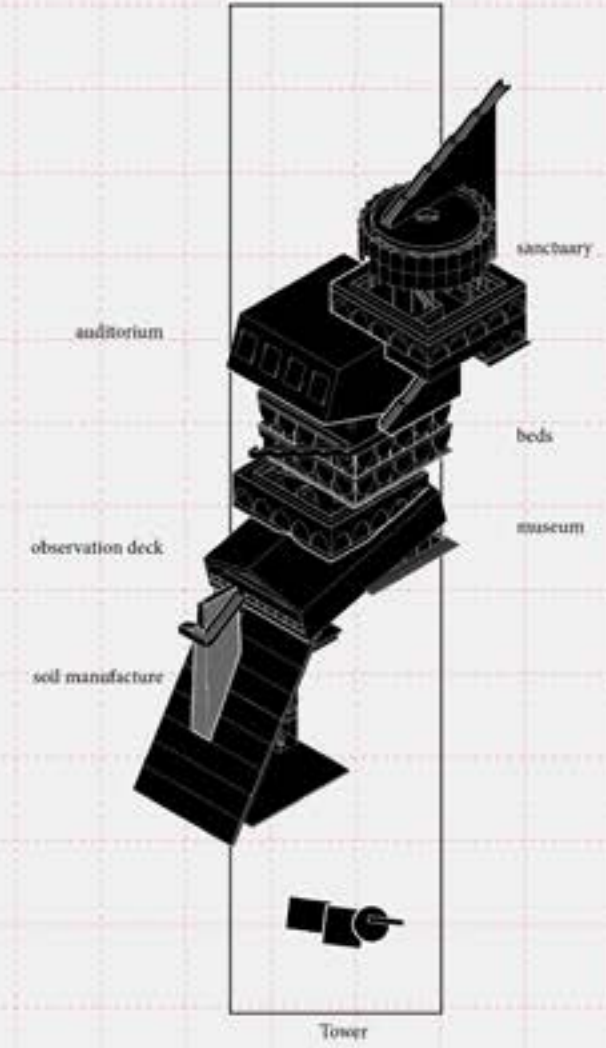

Tahawus

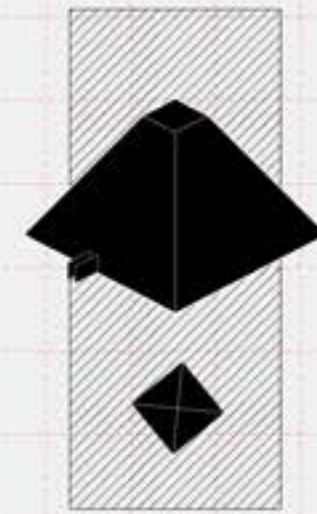

Rammed Tailing Monument

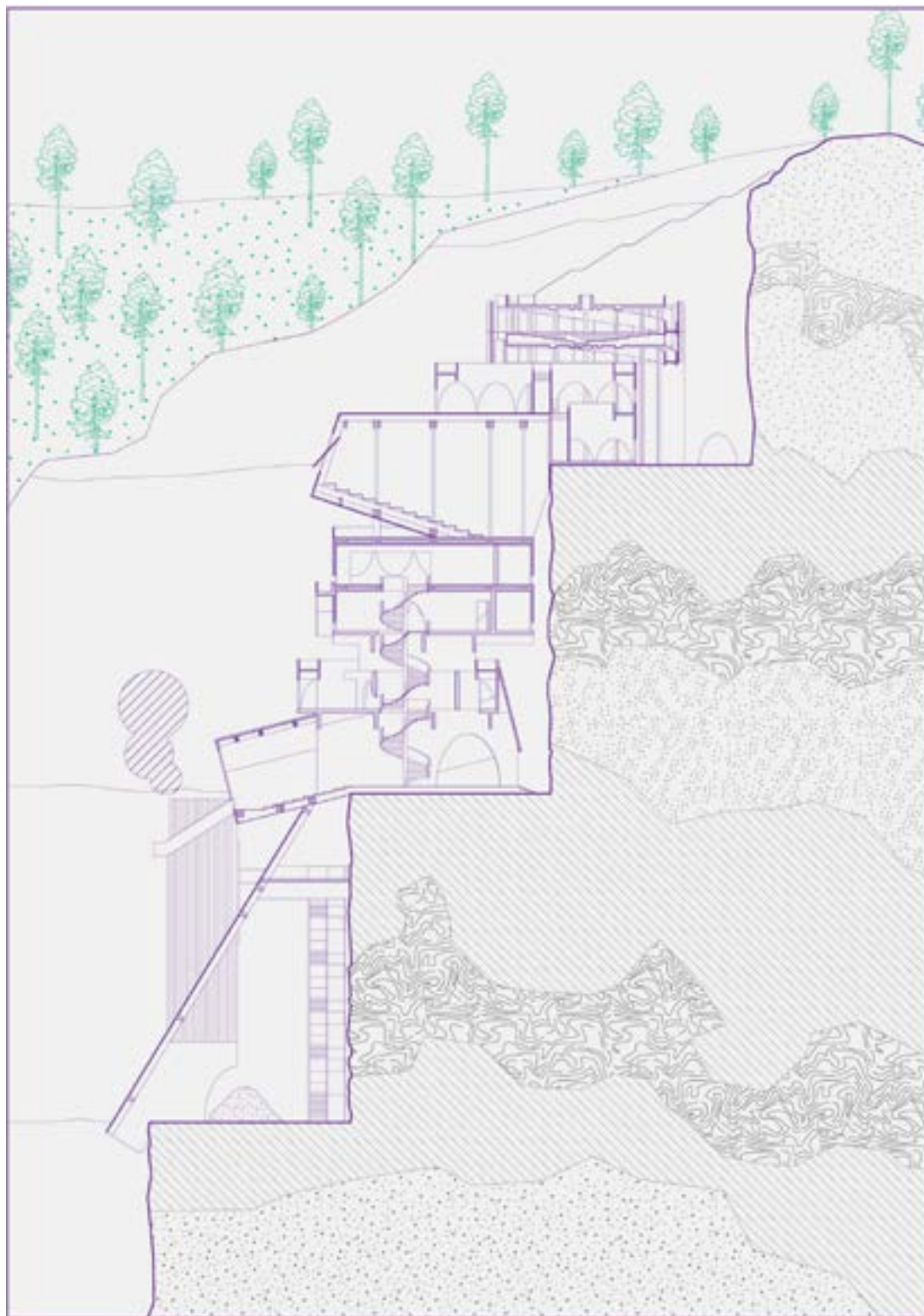

The site presents a particular opportunity for the Center for Earth Ethics to establish a center for land rehabilitation and memorial site. The two go hand in hand and perfectly attuned with the CEE's mission of caretaking for the earth through a faith-based approach. By rehabilitating the site and assigning meaning to the site's monuments, the CEE can ensure an education program on methods of caretaking and the perils of our current extraction for years to come.

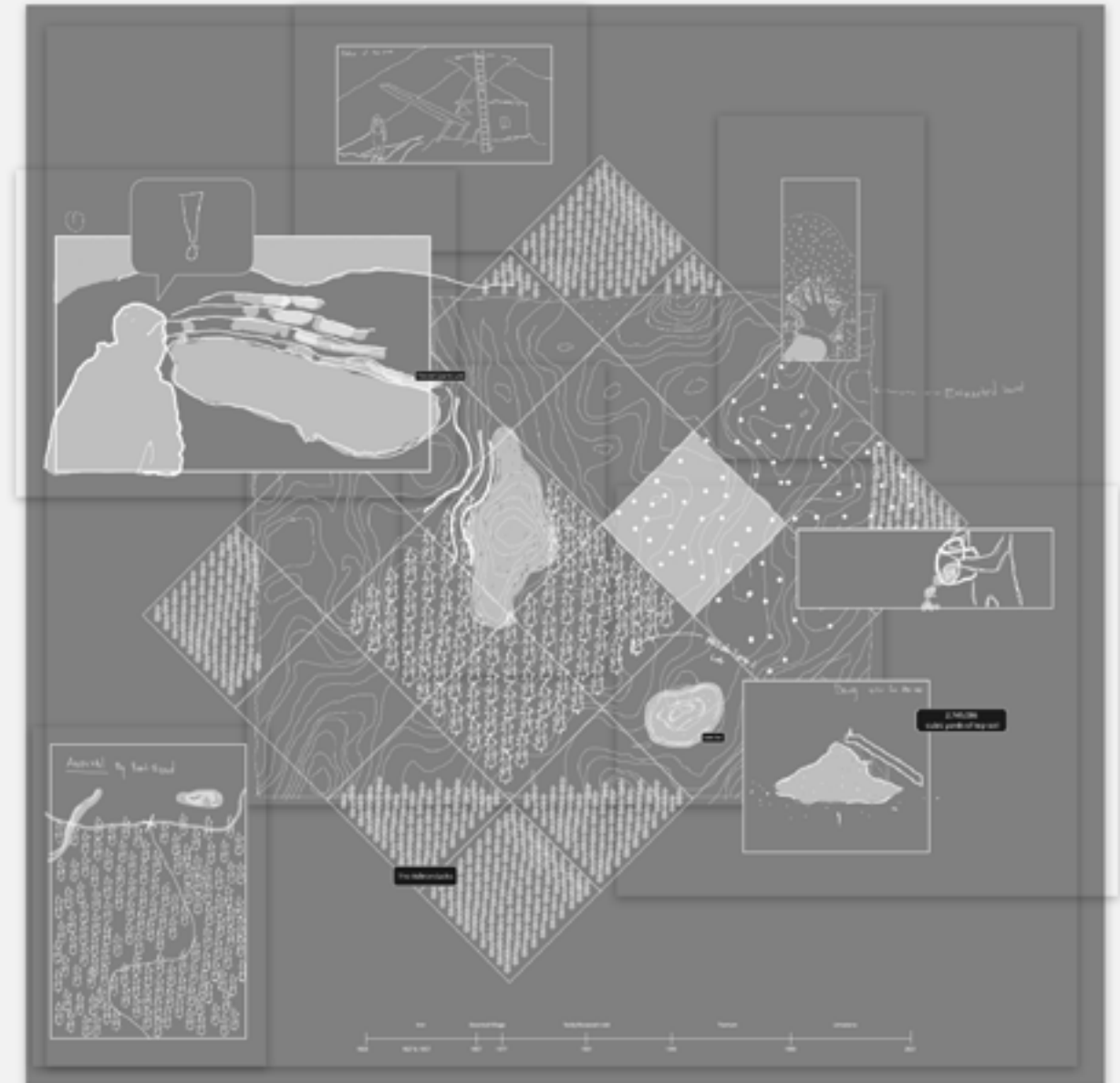
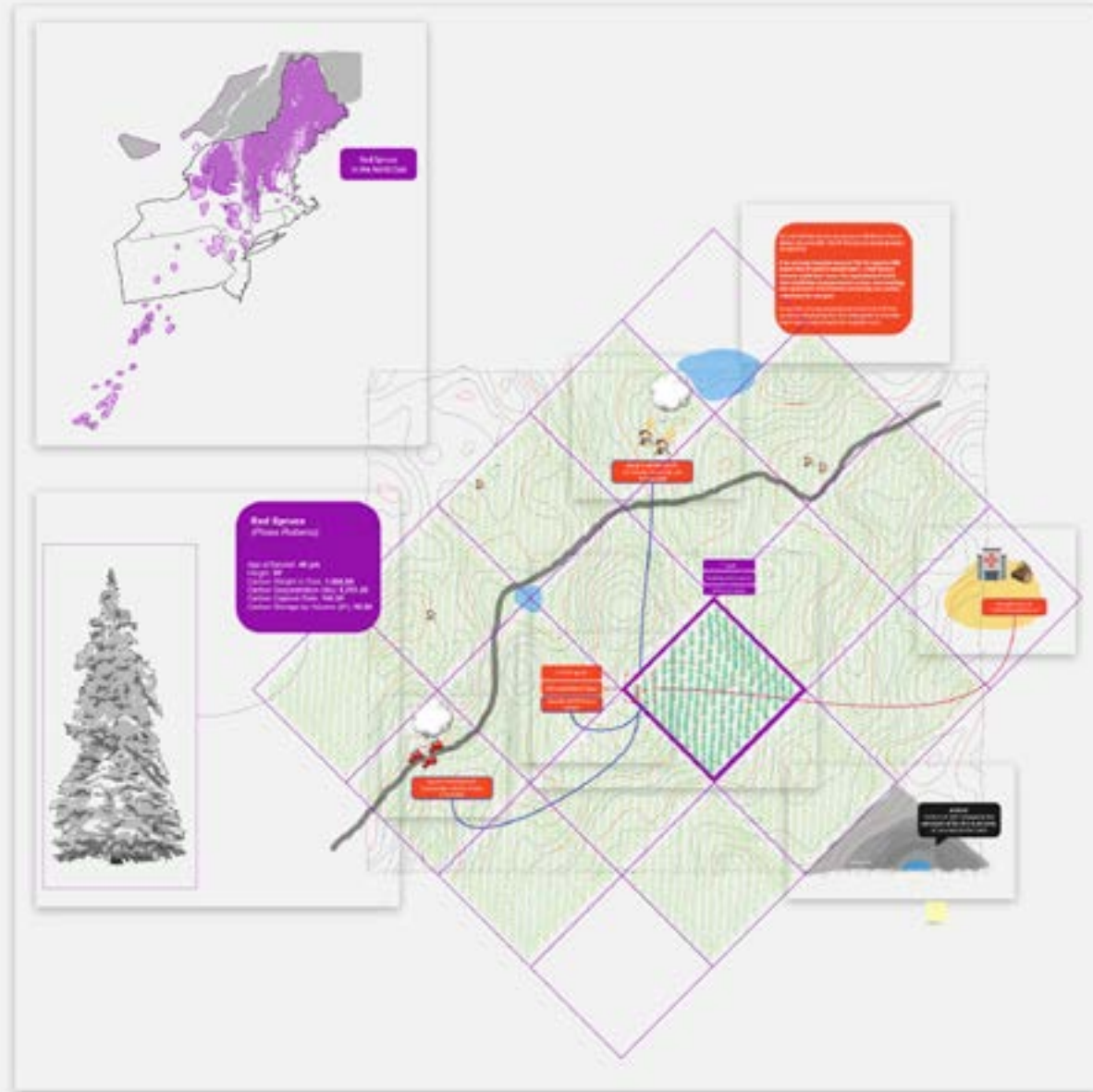

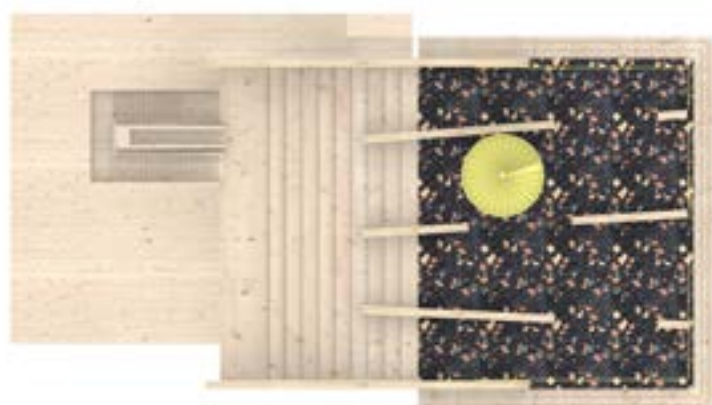
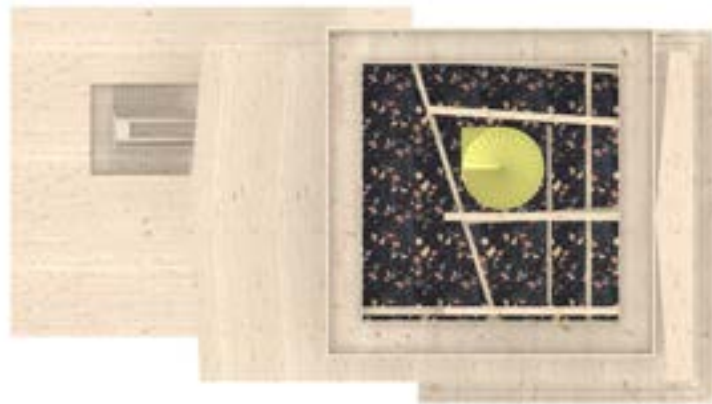
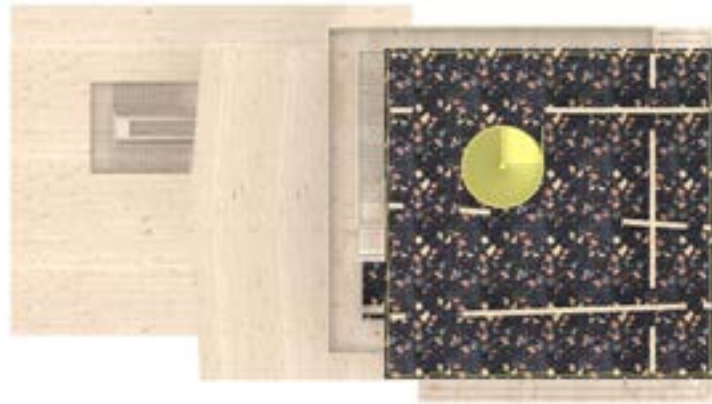

The project proposes a CLT tower against the 400 ft tall quarry wall that will serve as the headquarters for the site's rehabilitation operations, and site planning for the site to grow around it. These operations not only refer to the industrial machinery but also include the participation of visitors in the process of soil production and the faith rituals through which many will approach their visit.





Gallery & Observation Deck



9
10
11



Leisure



7
8

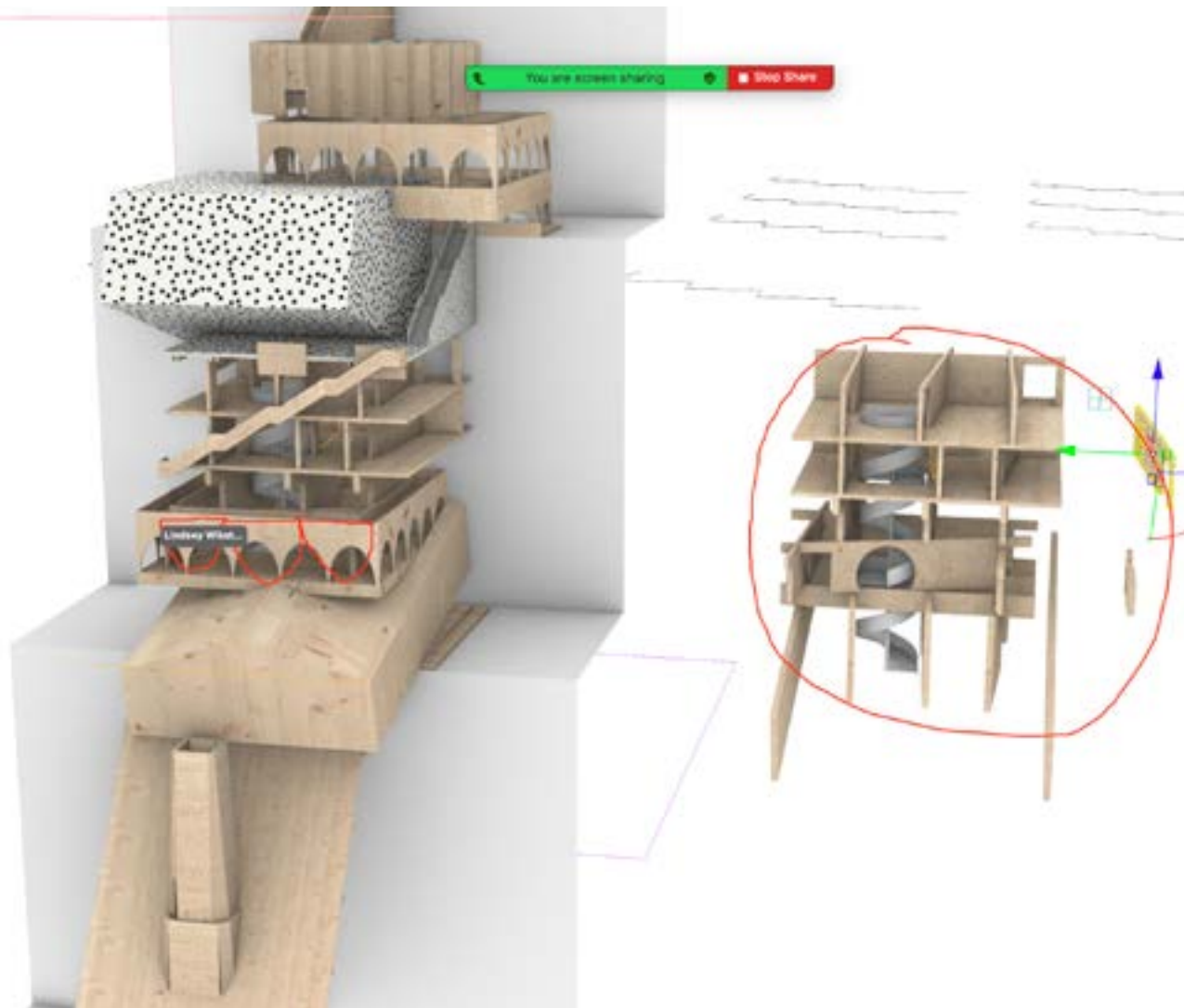

The tower consists of three main components: soil manufacturing, museum, and sanctuary. The tower also houses some dormitory and administrative space for the resident caretakers. Given the particular condition of its context, the tower steps back along the wall and reaches the top on its backside, extending an entrance for the visitors to descend onto the tower through the sanctuary before moving down to the museum and observation deck, and finally arriving at the soil manufacturing area where they'll prepare before heading out to the field to participate in the habilitation.

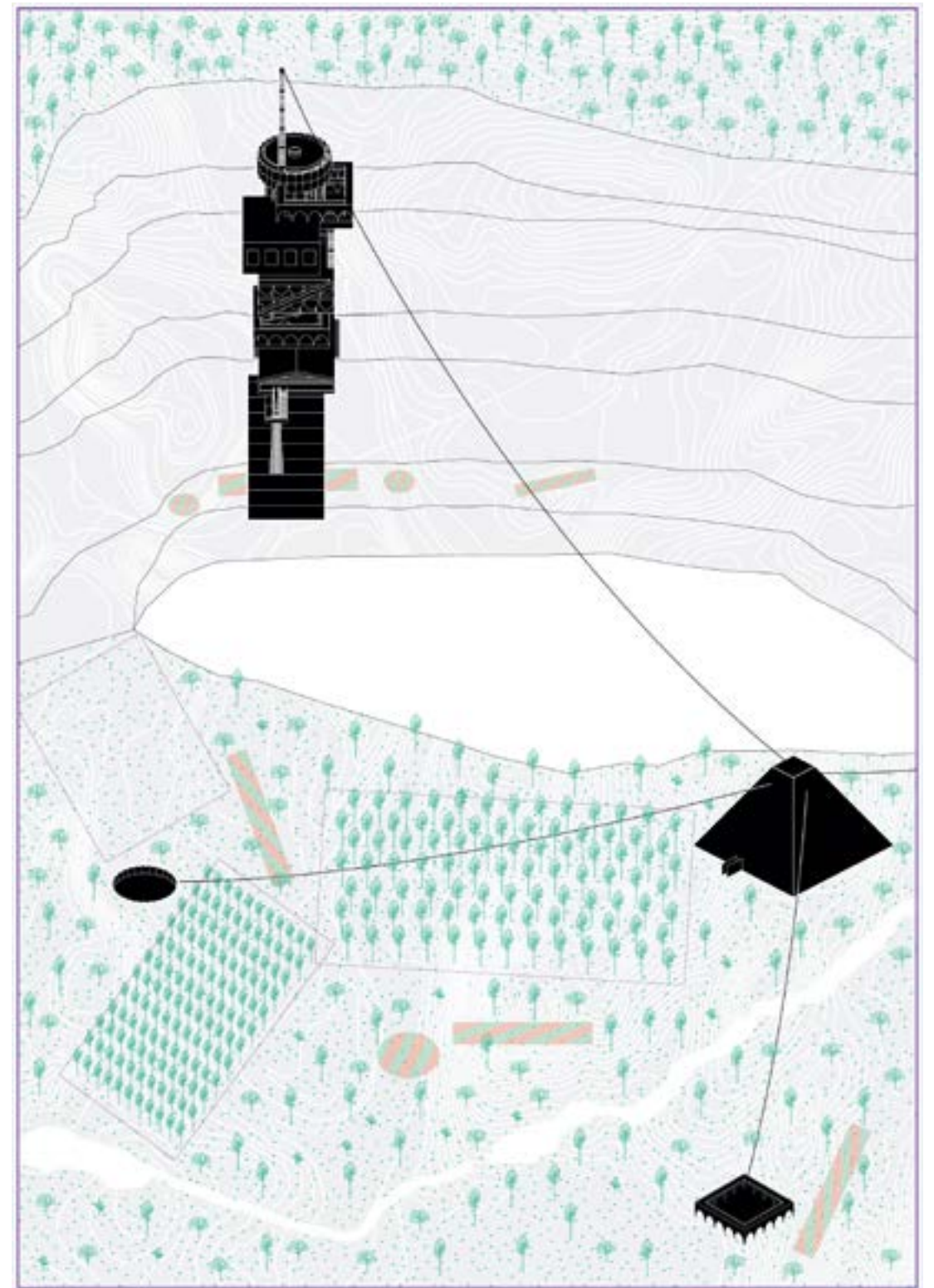

5. ECOSYSTEMS OF DISSENT

Ecosystems of Dissent presents a series of techno-social fictional interventions around New York City which allow for alternative ways to engage with data infrastructure.



On 33 Thomas street, a 29-story windowless telecommunications building is the source of many debates and suspicions, and stands as the embodiment of telephone system architecture: anonymous, brooding, and forbidding. This building operates beyond its property line, and is part of a larger network its elements span from the global scale to the smallest detail. The building's exterior wall sandwiches cables in layers of concrete, terracotta, and granite. Through this wall detail, many narratives unravel the political complexities and constructs which operate for the sake of the system.

As corporate telecommunication buildings evolved around the world, infrastructural systems have gradually been concealed through methods of black-boxing, limiting them to the realm of experts. By eliminating entire material narratives that carry accountability, these corporations became active participants in the production and centralization of secrecy and power.

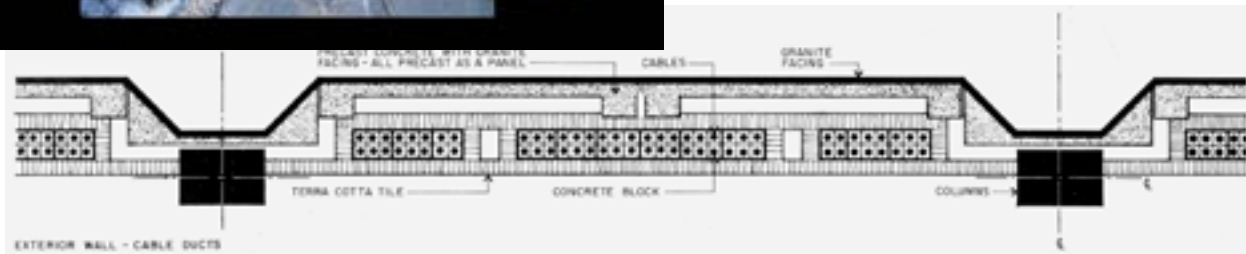

**FOR THE SAKE
OF
PROGRESS**

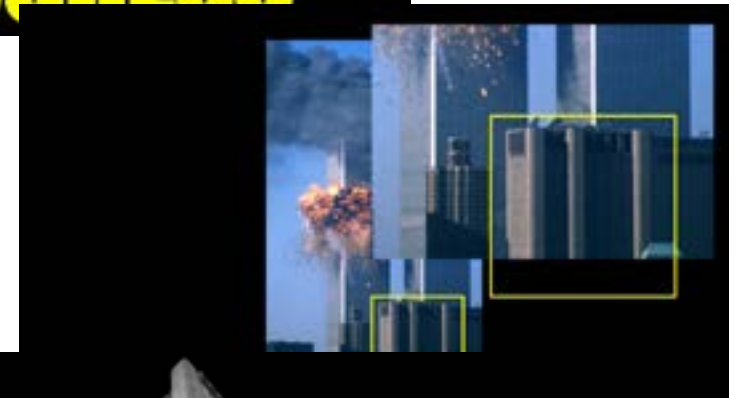

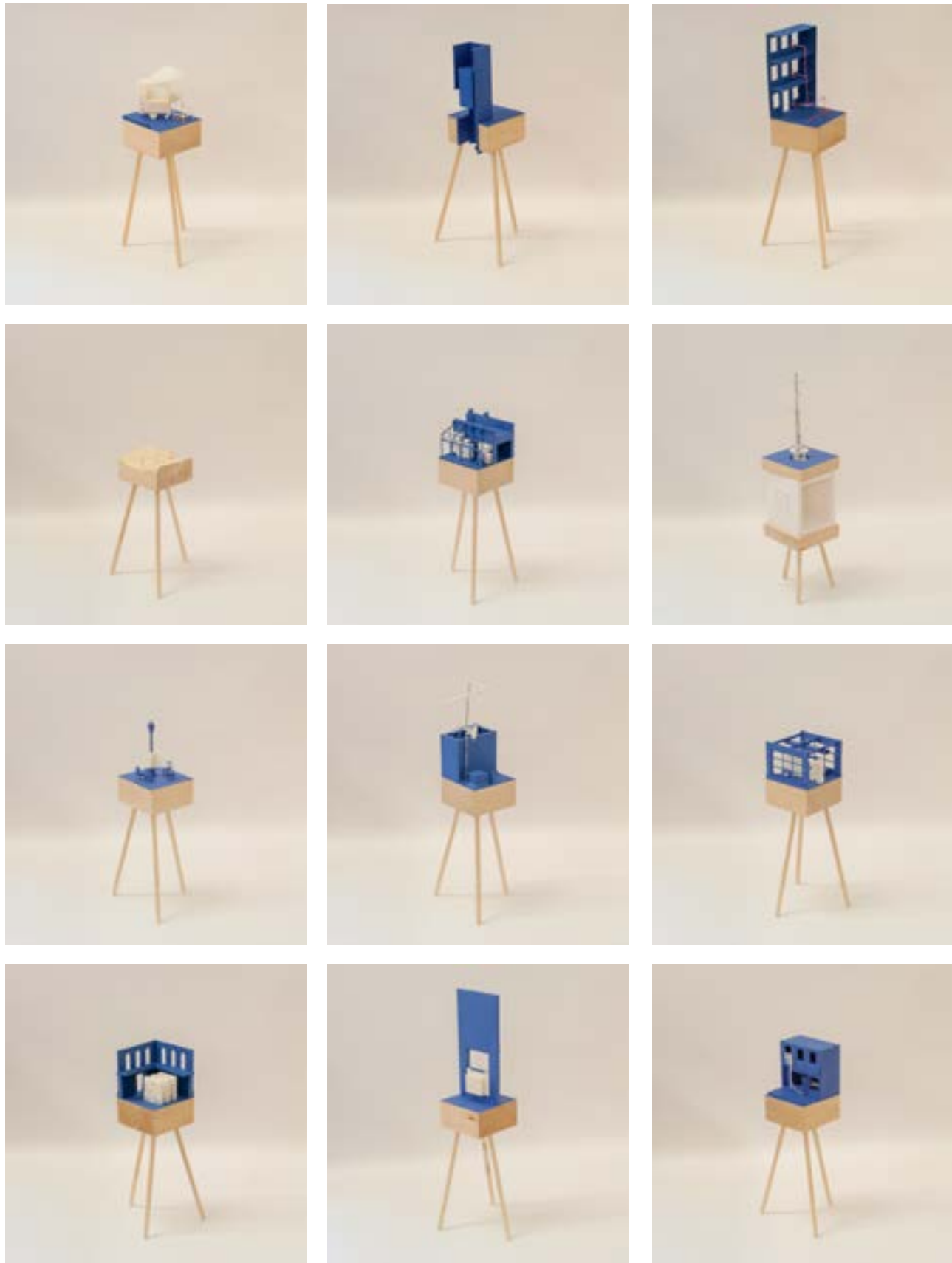



Ecosystems of Dissent presents a series of techno-social fictional interventions around New York City which allow for alternative ways to engage with data infrastructure. These independent scenarios act to undermine the centralized hegemonic system of communication. They do so by rethinking adjacencies to infrastructure, what it means to maintain it, rewriting contracts, and expanding dissenting initiatives.

By mapping the infrastructural breaking points of this system, and bringing forward an alternative ecosystem of dissent, unanticipated political and aesthetic capacities can emerge which rethink how power is enacted as an urban reality. Episodes are brought forward, recreated spatially, and understood in their social capacities, as well as through the specific infrastructural element that allows for its interactions.

Ecosystems of Dissent

THESE ARE THE PROTOTYPES OF THE ECOSYSTEMS OF DISSIDENT. THEY ARE THE RESULT OF A COLLECTIVE PROCESS OF DESIGN AND CONSTRUCTION. THEY ARE THE RESULT OF A COLLECTIVE PROCESS OF DESIGN AND CONSTRUCTION. THEY ARE THE RESULT OF A COLLECTIVE PROCESS OF DESIGN AND CONSTRUCTION.

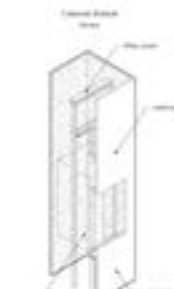
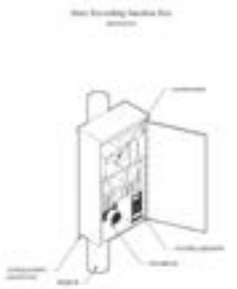
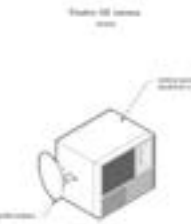
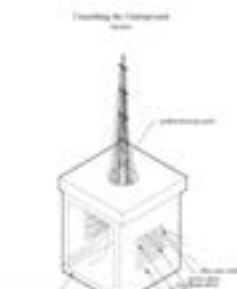

Ecosystems of Dissent

THESE ARE THE PROTOTYPES OF THE ECOSYSTEMS OF DISSIDENT. THEY ARE THE RESULT OF A COLLECTIVE PROCESS OF DESIGN AND CONSTRUCTION. THEY ARE THE RESULT OF A COLLECTIVE PROCESS OF DESIGN AND CONSTRUCTION.









The installation is a tool to visualize the multiscalar relationships in which the ecosystem operates. The material is meant to be physically explored around the map and with the handheld guiding pamphlet.

15

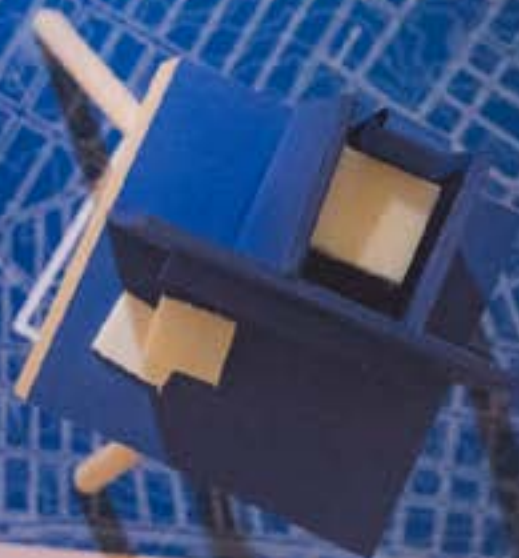

FOR THE SAKE OF NATIONAL SECURITY

The the case of National Security, the House in its report found that the intelligence community is not doing enough to protect the nation's secrets. The report is said to be a warning to American citizens about the risks of spying.

House Intelligence Committee Chairman James Inhofe said the report is a warning to American citizens about the risks of spying. The report is said to be a warning to American citizens about the risks of spying.

House Intelligence Committee Chairman James Inhofe said the report is a warning to American citizens about the risks of spying. The report is said to be a warning to American citizens about the risks of spying.

House Intelligence Committee Chairman James Inhofe said the report is a warning to American citizens about the risks of spying. The report is said to be a warning to American citizens about the risks of spying.



33 THOMAS STREET

The building is a 33-story skyscraper in New York City. It is the tallest building in the world. The building is a 33-story skyscraper in New York City. It is the tallest building in the world.

The building is a 33-story skyscraper in New York City. It is the tallest building in the world. The building is a 33-story skyscraper in New York City. It is the tallest building in the world.



Towel Bathhouse



A bathhouse with every room in a different material. A room made of towels from roof to floor, to walls and even the stairs; a bath made of silicone; a hall in concrete; all buried under thick snow. This project is an exploration into textures and lighting through renderings.

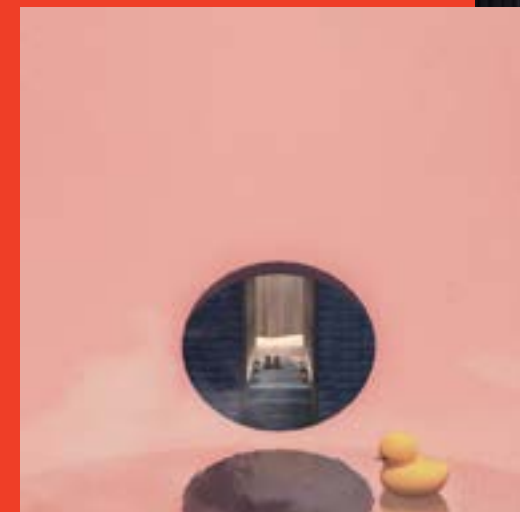

6. MAKERGRAPH

Makergraph is not just a book, it is collection of books, cards, manuals, and polaroids, all props that explore the familiarity of four objects and their properties, and the nature of their meaning.



Amidst the chaos that was life in isolation for the past two years, I came to find some comfort and relief in my obsession for household objects. Whether it was a nice piece of furniture found on the street, or a bright-colored set of towels, they had a way to stimulate imagination and leave your mind to wander. When it came to making, my obsession for these objects kicked in. For me, making was more about reimagining the mundane objects I had observed with wonder in the previous months.

This book is not just a book, it is collection of books, cards, manuals, and polaroids, all props that explore the familiarity of four objects and their properties, and the nature of their meaning. Each of the objects studied maintains a relationship with their original piece, not as raw material, but as the object that sparked its own transformation. By dissociating the objects from their material properties, they cease to function as they were intended, or even function at all, but new artifacts are generated, facilitating new perspectives and critical observations on their essence.

If you want to engage with objects around you, sometimes it's enough to just flip them over.



Makergraph



Wood







Makergraph



Fabric





2
Wood

4
**FABRIC
NOT WEARING
THE TOWEL**
[127]

Amids
past t
relief
Wheth
street,
way to
wande
these
about
observ

This bo
books,
explore
propert
the obj
their or
object t
dissoci
propert
intende
are gen
critical

If you w
sometim



I was hesitant about not having crafted the object, it seemed like a cheat. There are many qualities to the material that I could have explored, but having found myself so attracted to the objects floating on the pond I came to realize my fascination with objects and their stories. I wanted to explore that aspect. Objects become artifacts once they tell a bigger story, and objects craft stories along their immediate context.

The trash can on Alma Mater's head could have been interpreted as an insult—had it actually covered her face— instead it was purely a silly hat. The statue is not just a statue, it is place of significance for the institution's identity. The trash can being there just brings up so many questions for whoever is looking. I wonder what comes up if I keep dressing Alma Mater up.

