

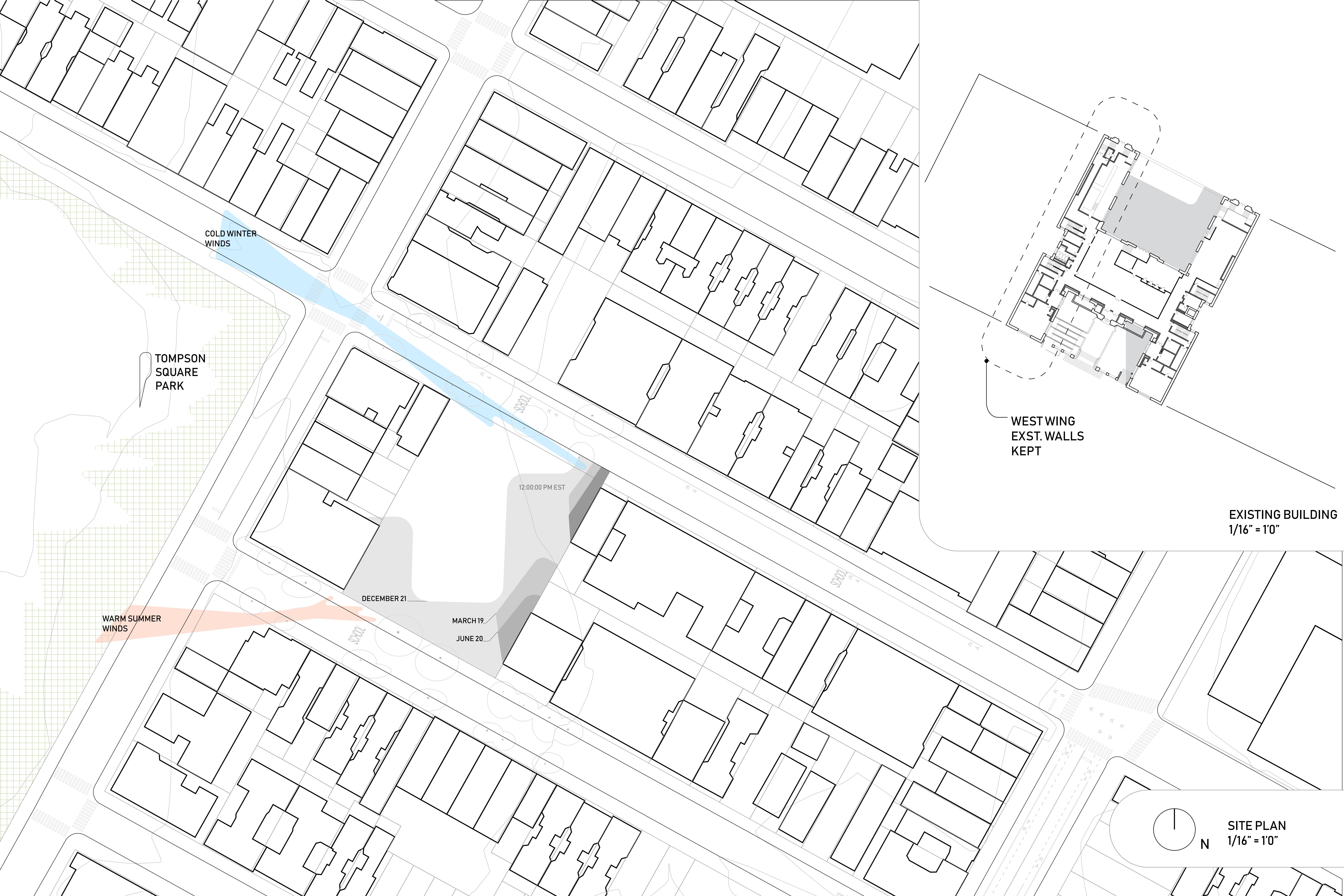

**STRUCTURE AS SPACE**





COLD WINTER WINDS

TOMPSON SQUARE PARK

WARM SUMMER WINDS

12:00:00 PM EST

DECEMBER 21

MARCH 19

JUNE 20

WEST WING EXST. WALLS KEPT

EXISTING BUILDING  
1/16" = 10"

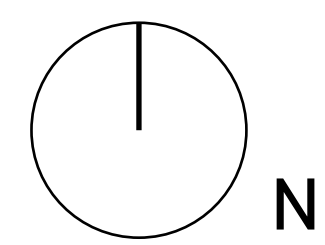

SITE PLAN  
1/16" = 10"



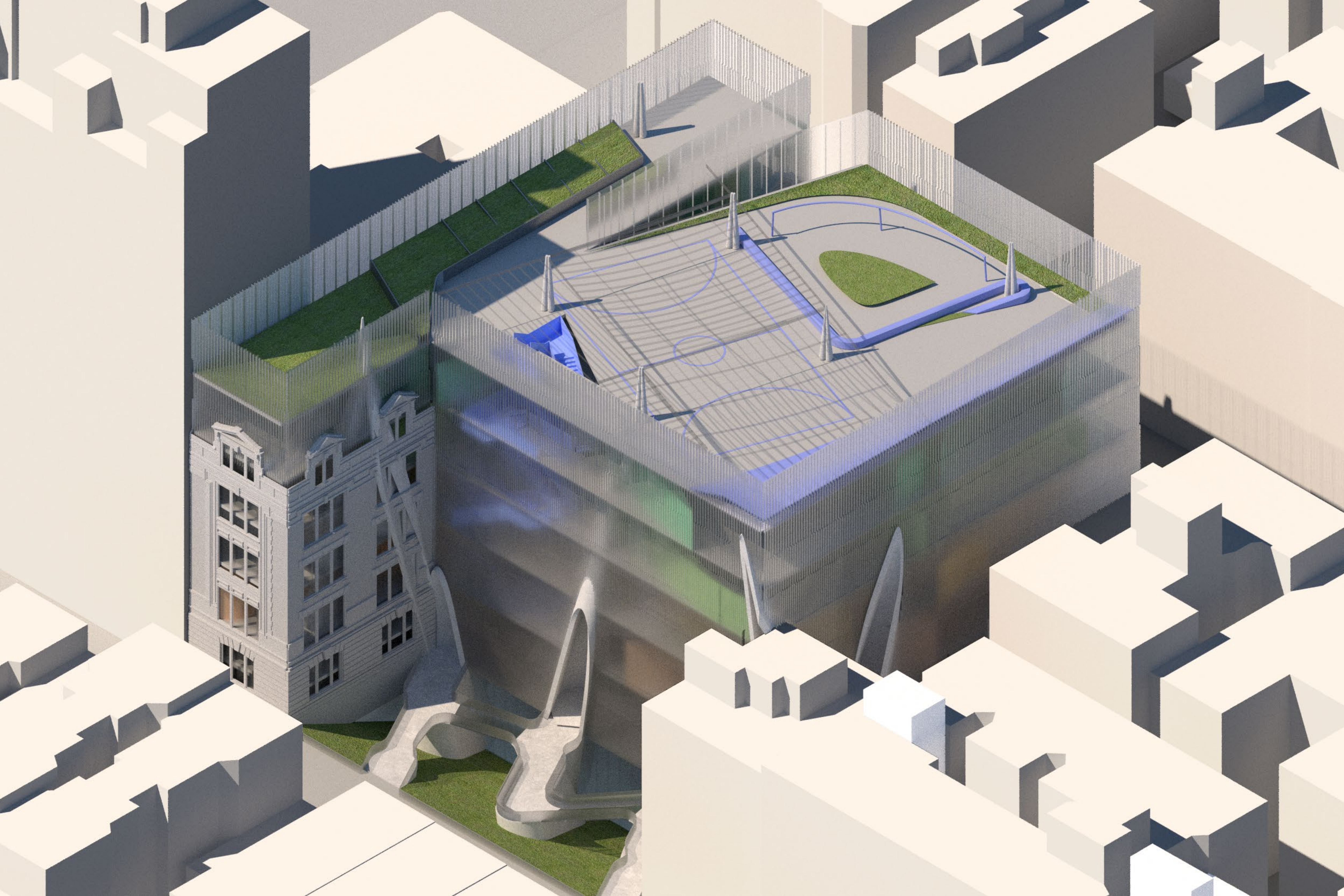



# CONCEPT

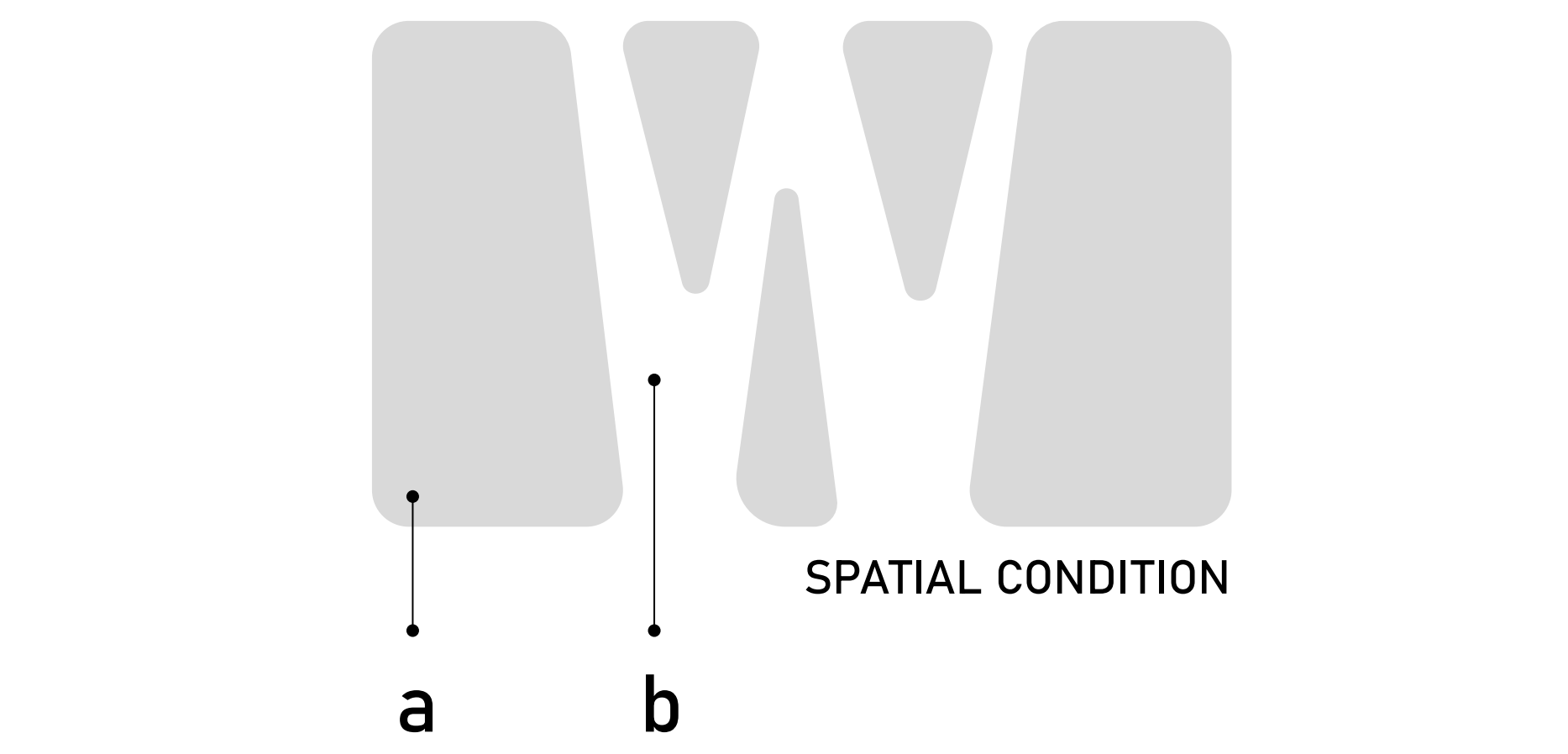
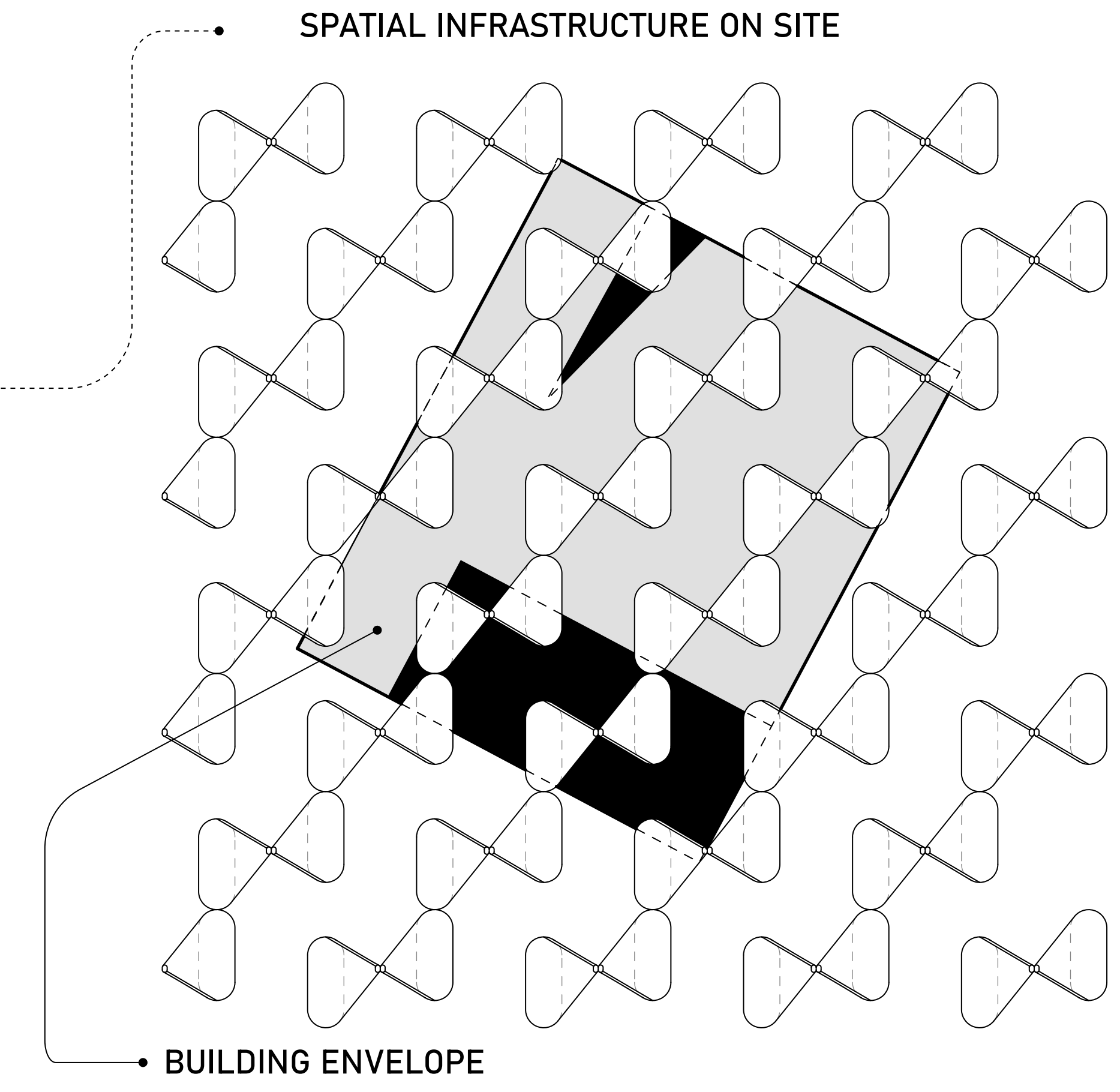
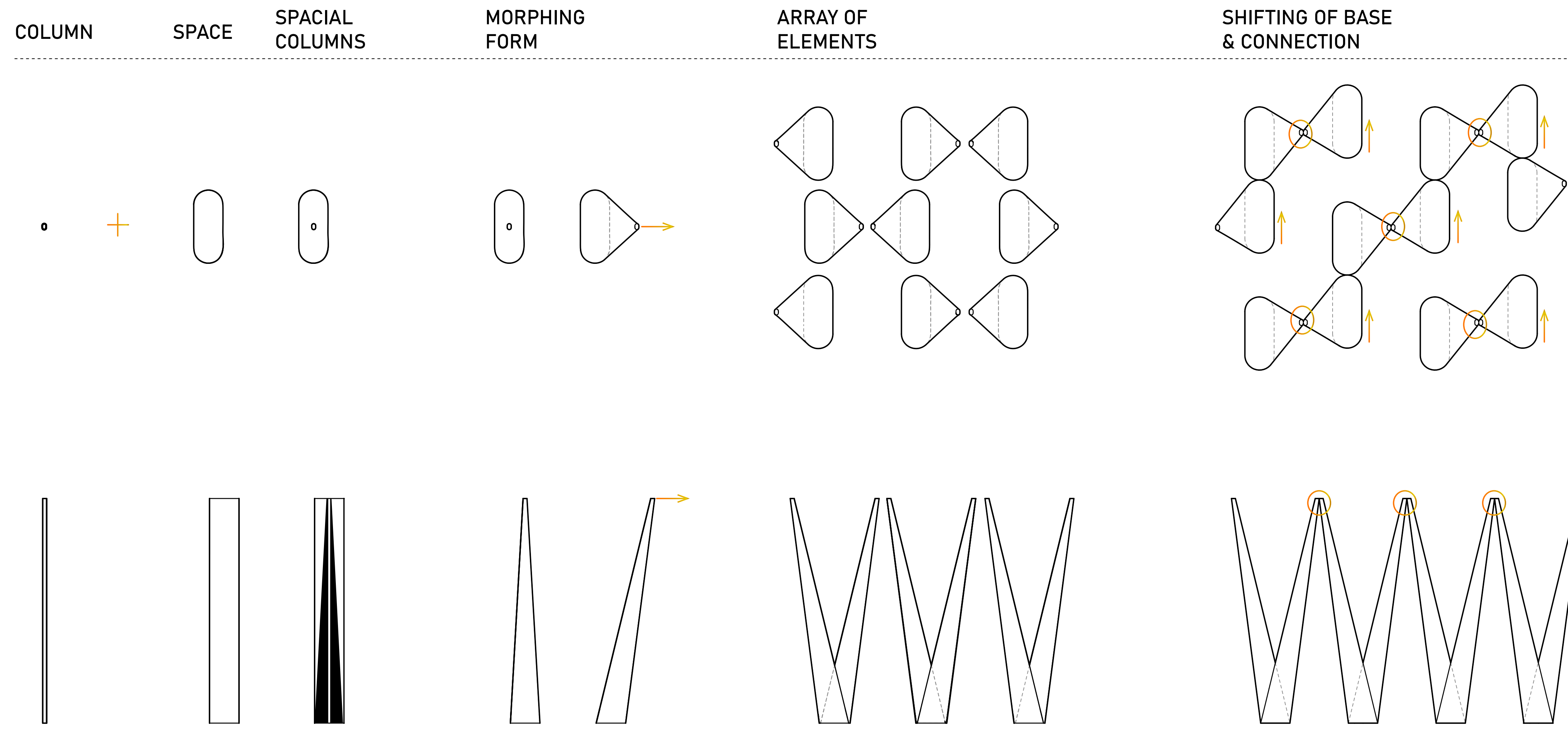

## PLAN VARIATION

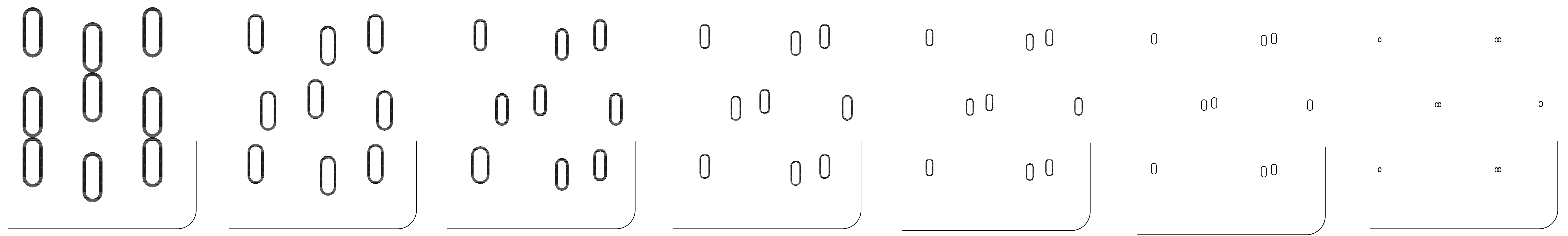

STRUCTURAL CORES

COLUMNS



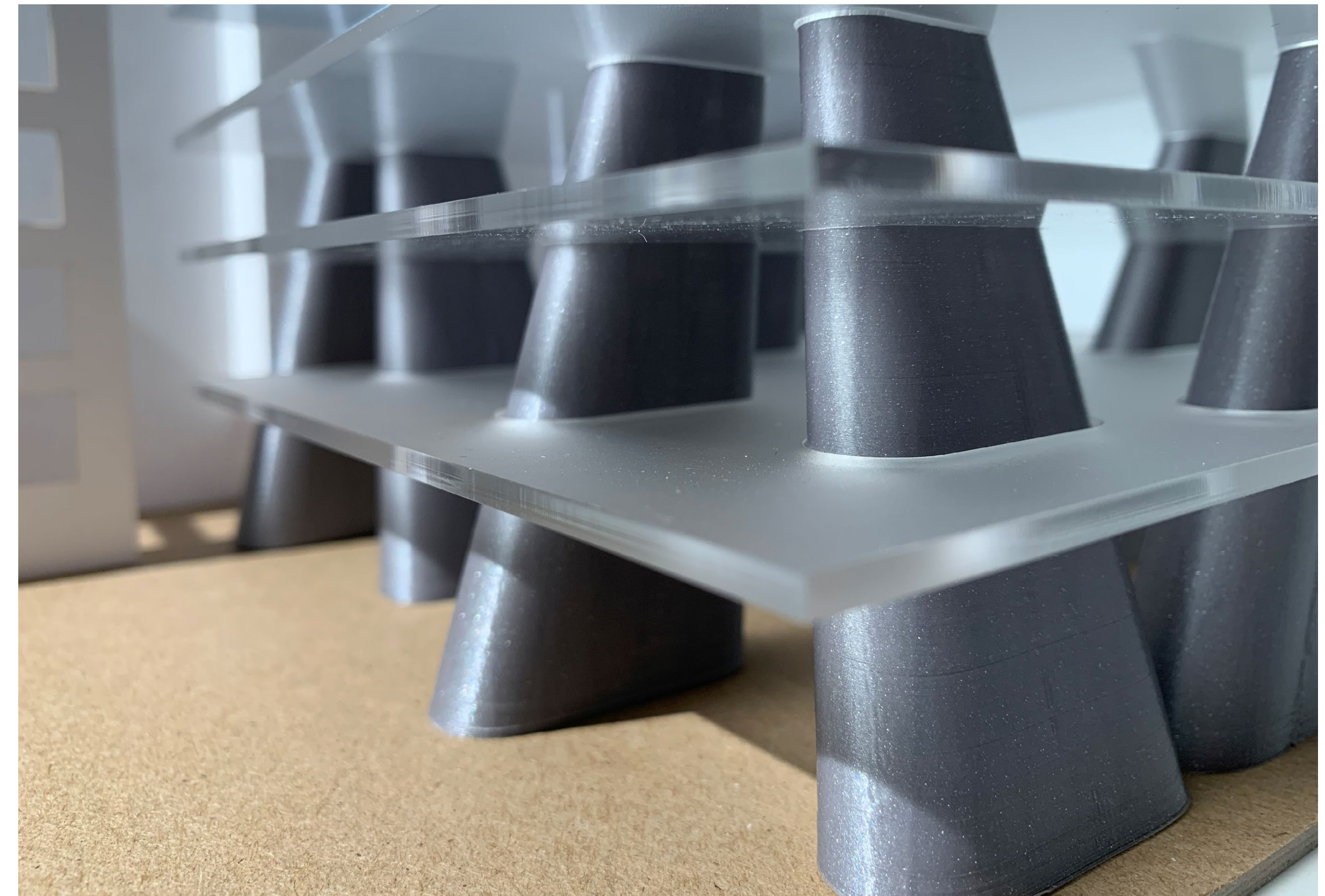
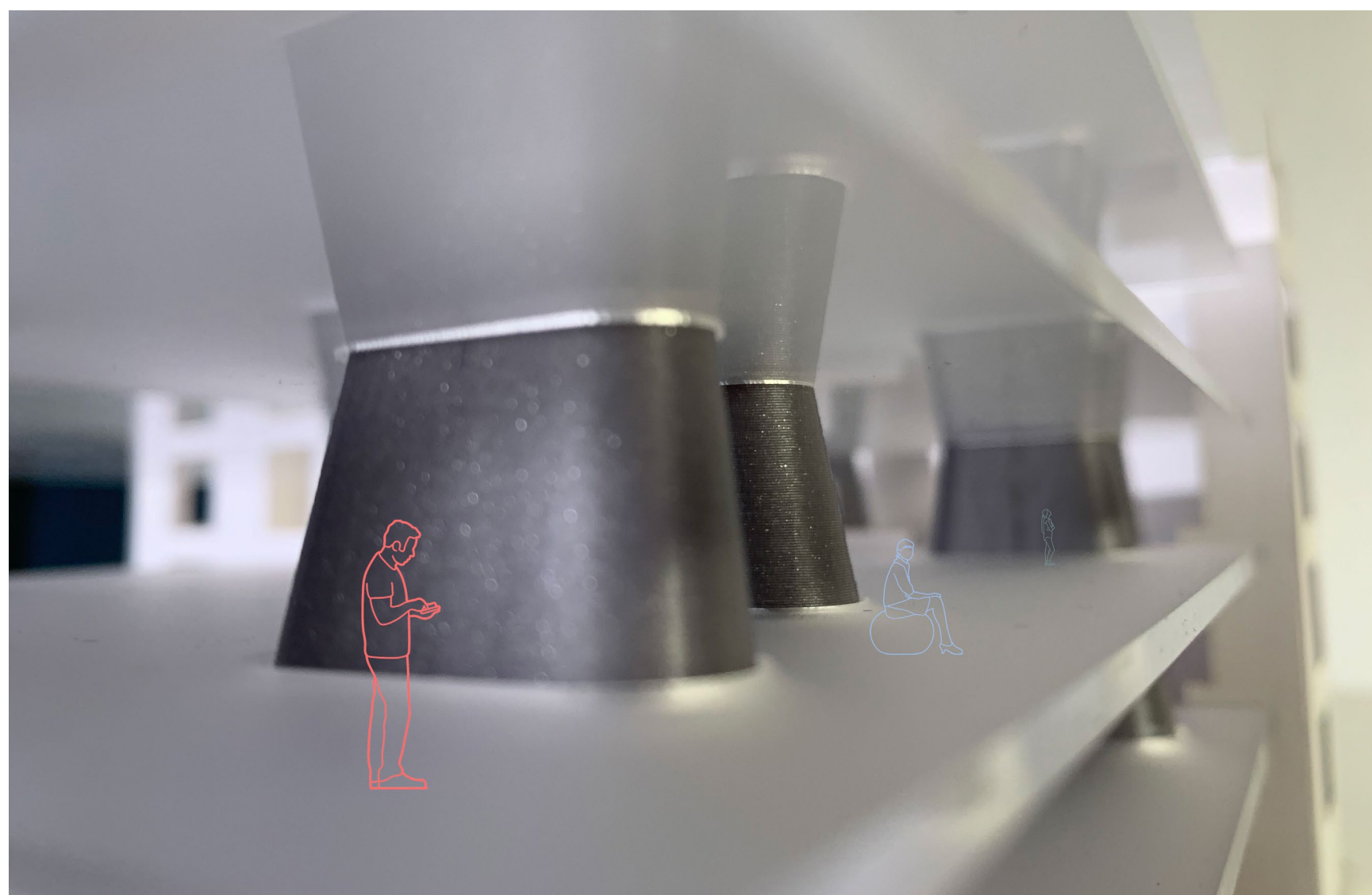
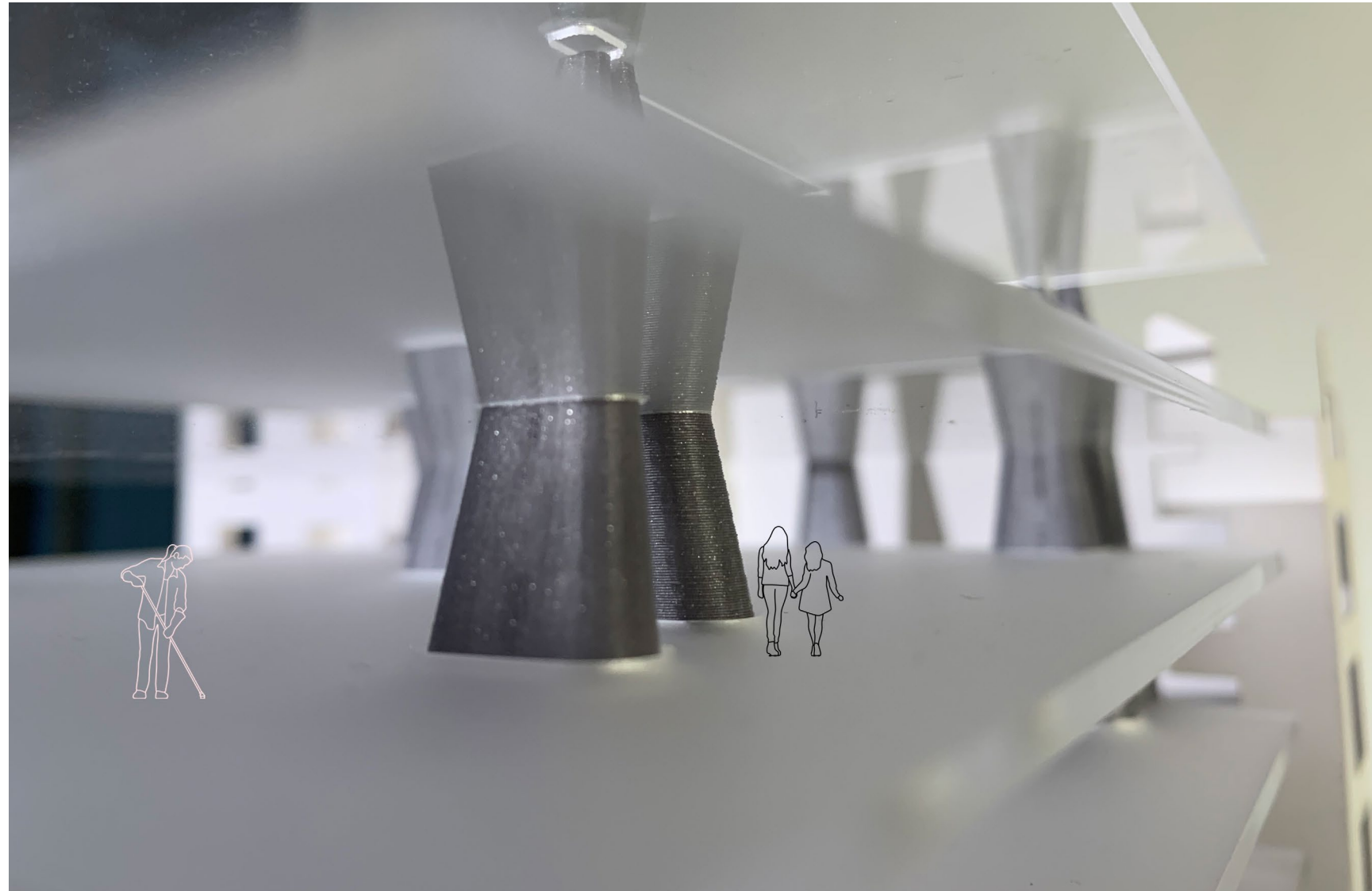
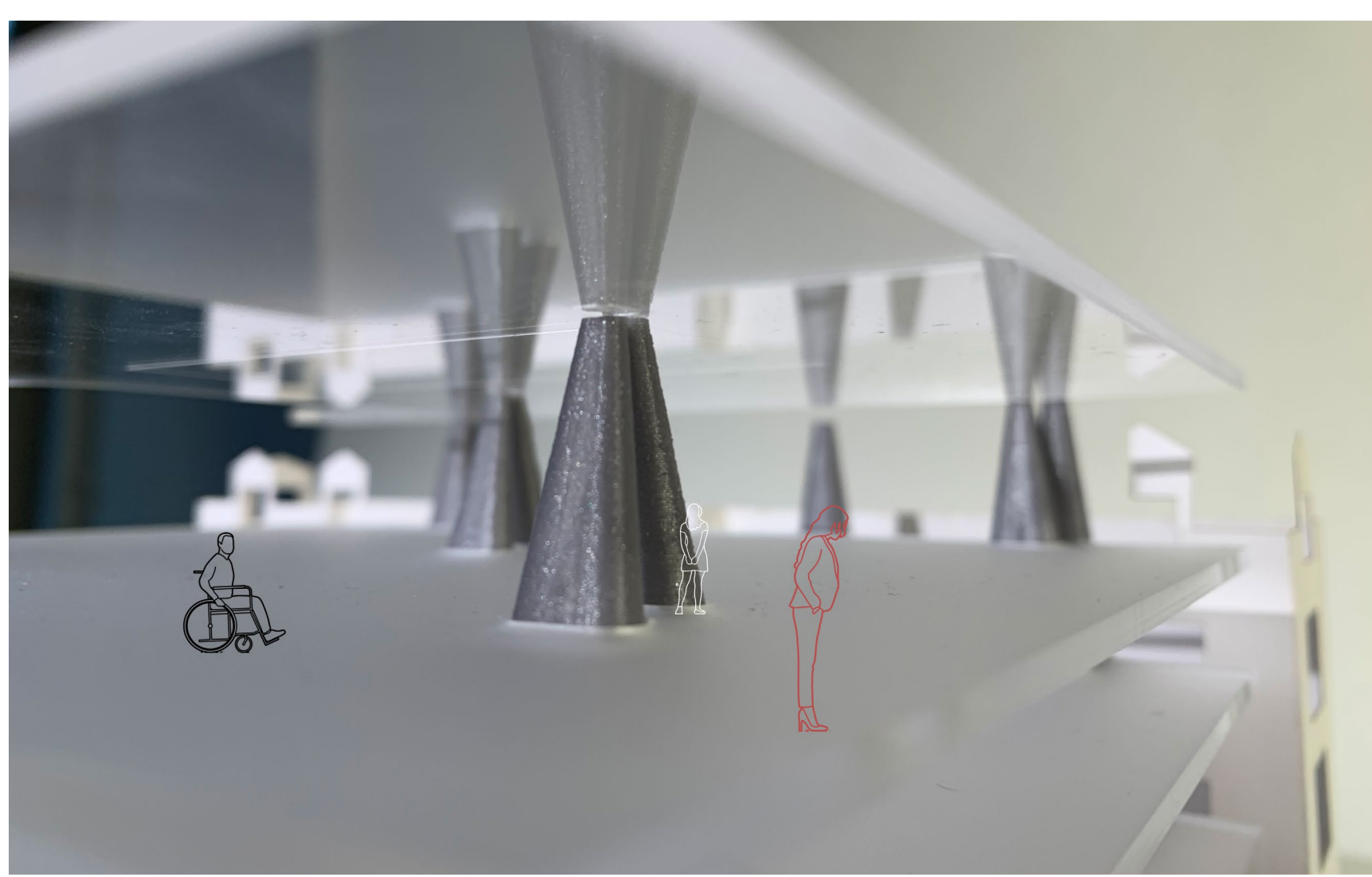



# PROGRAM

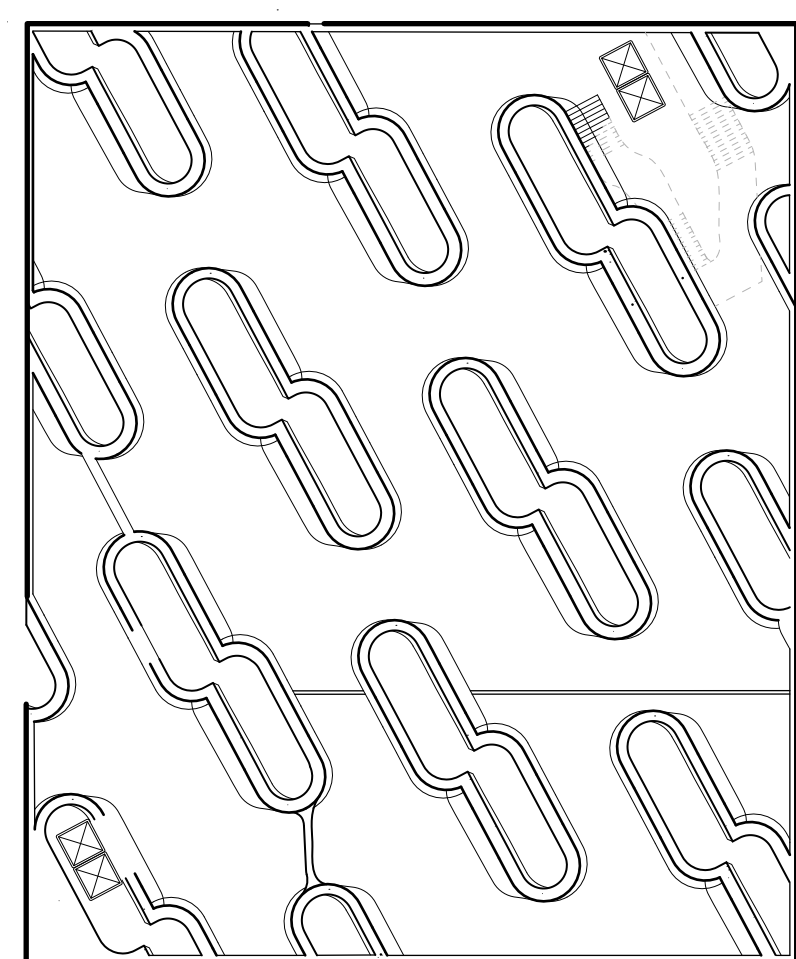
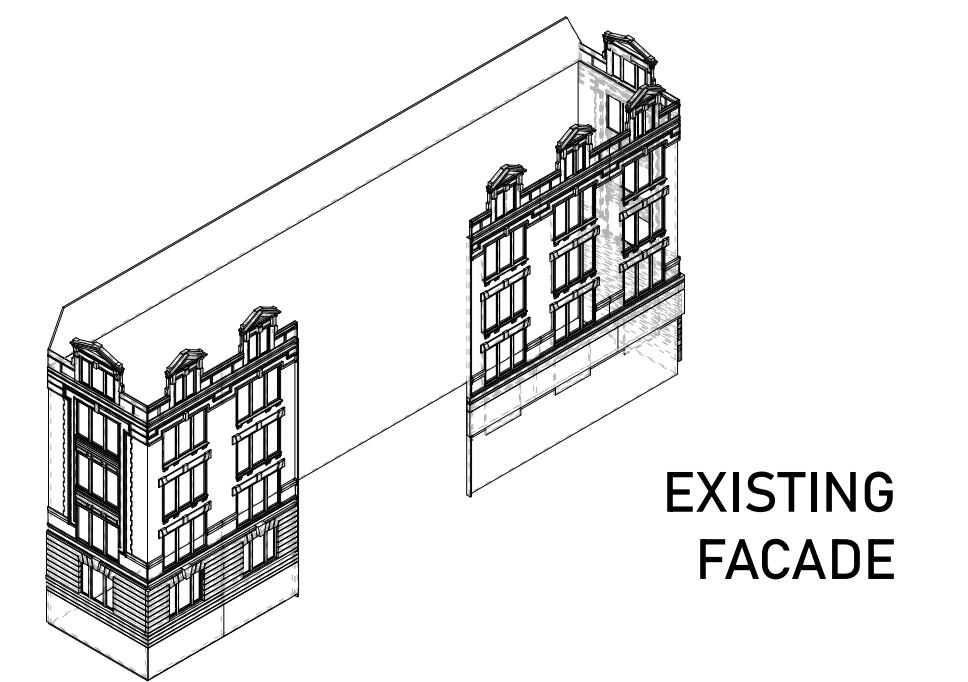
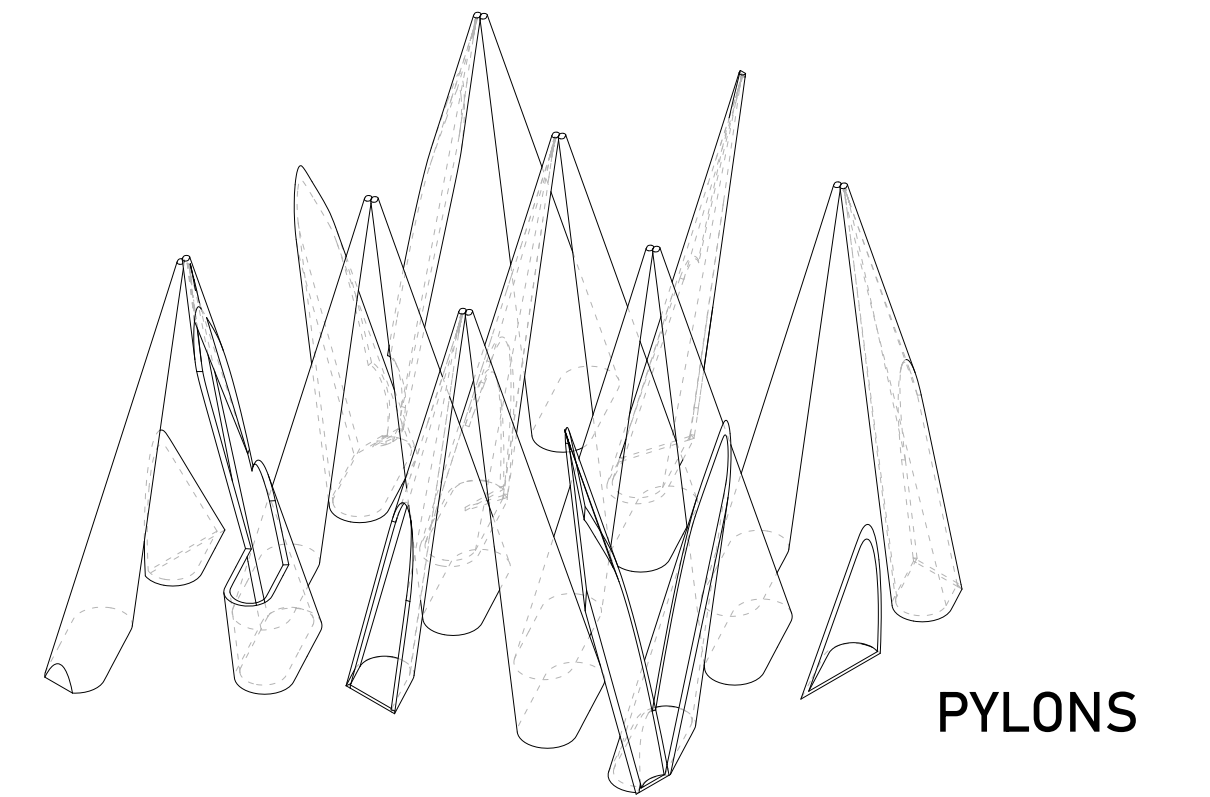
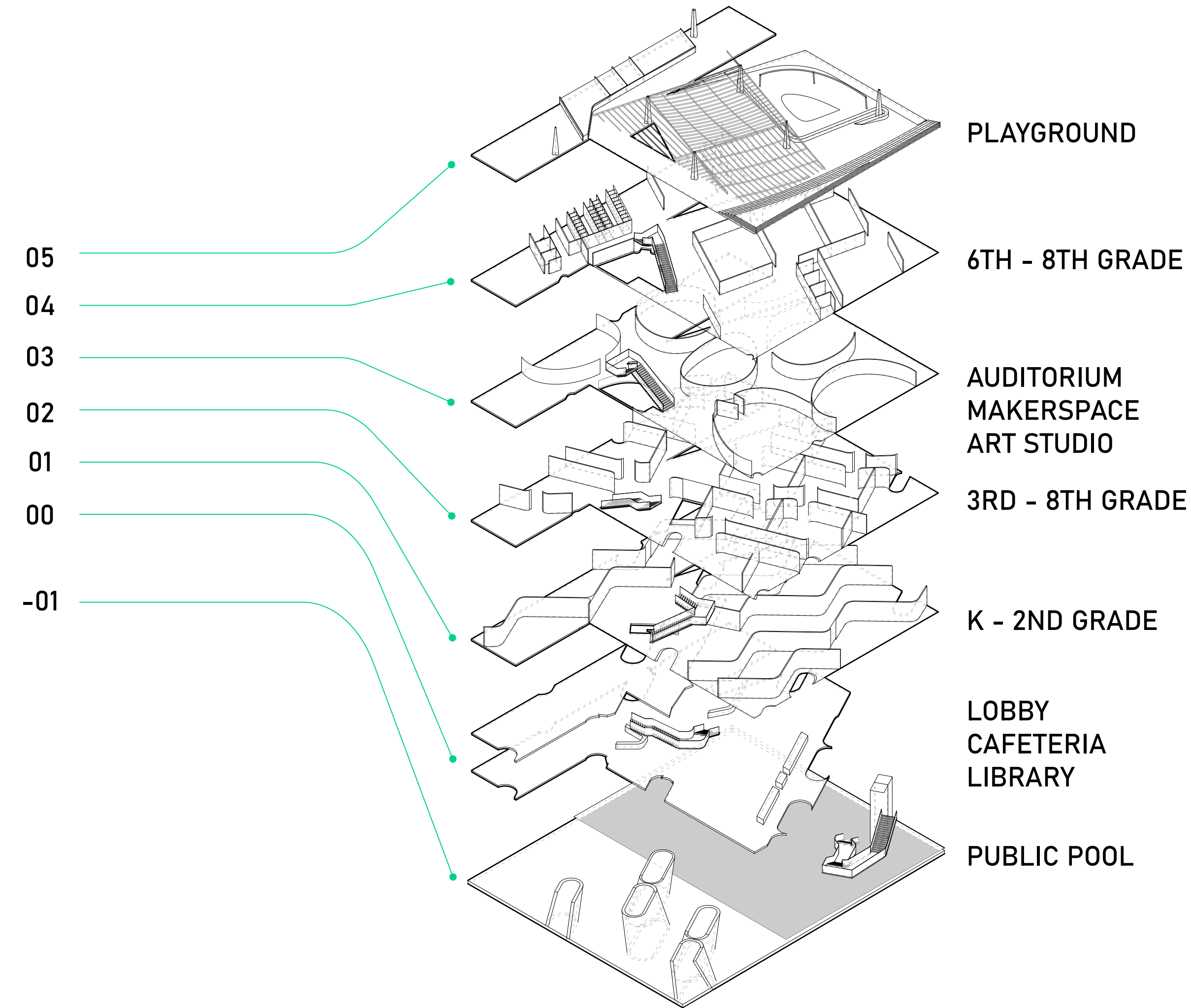
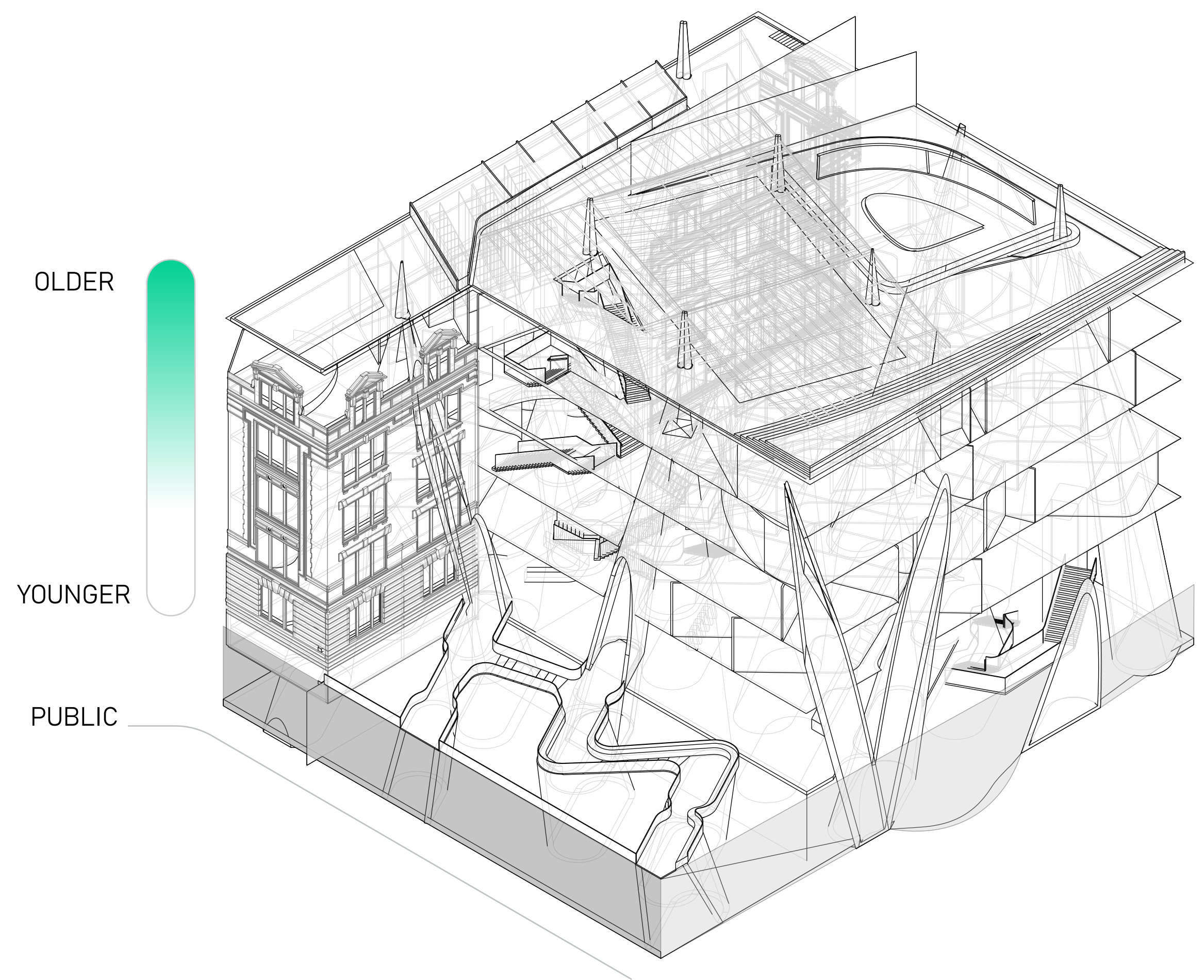

-01

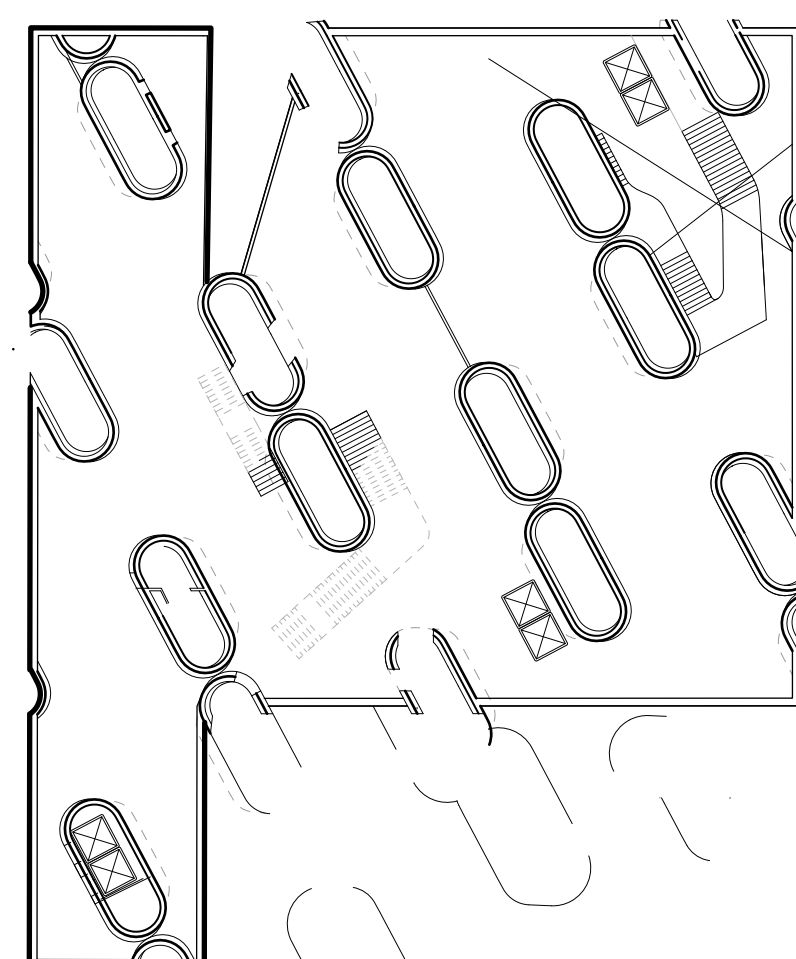

00

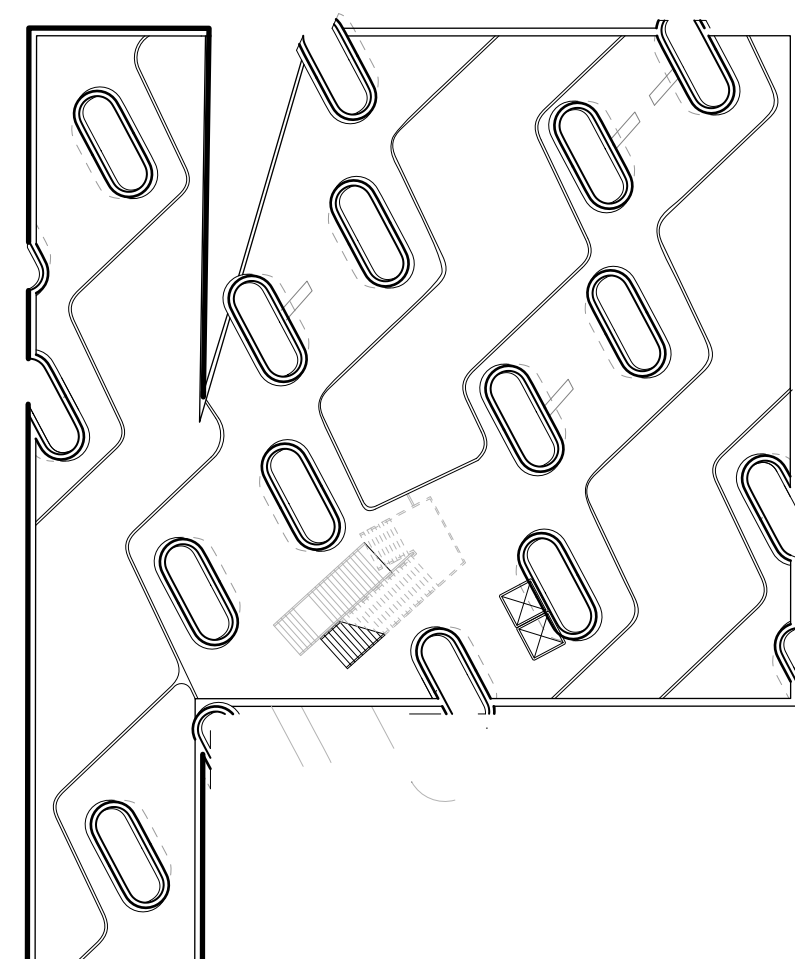

01

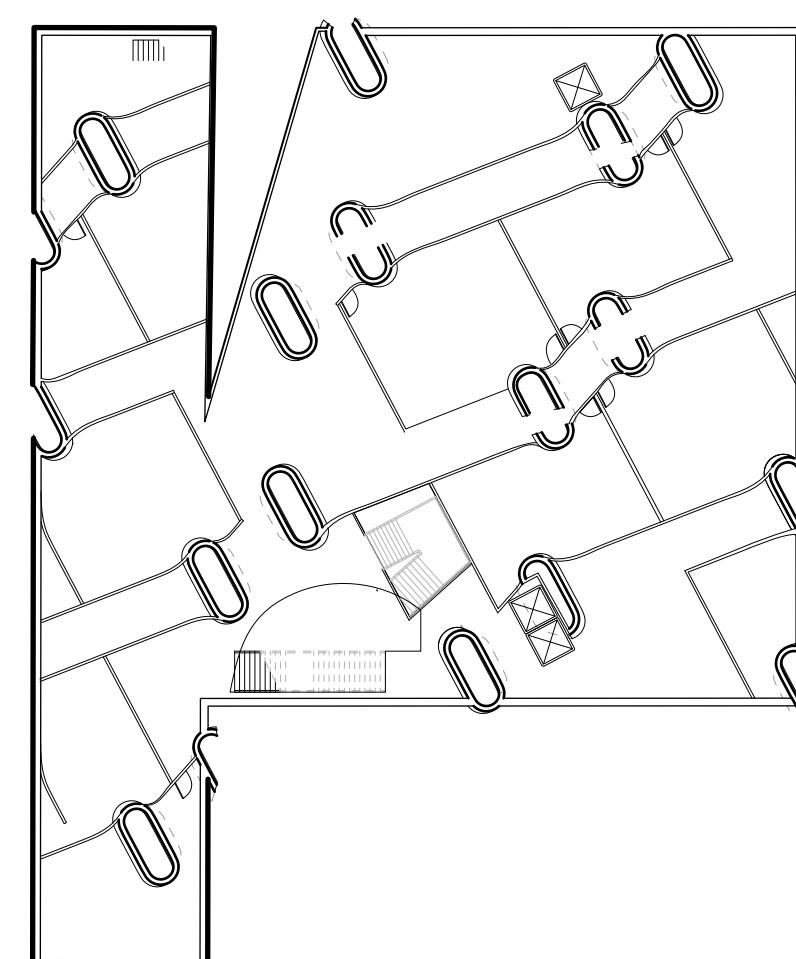

02

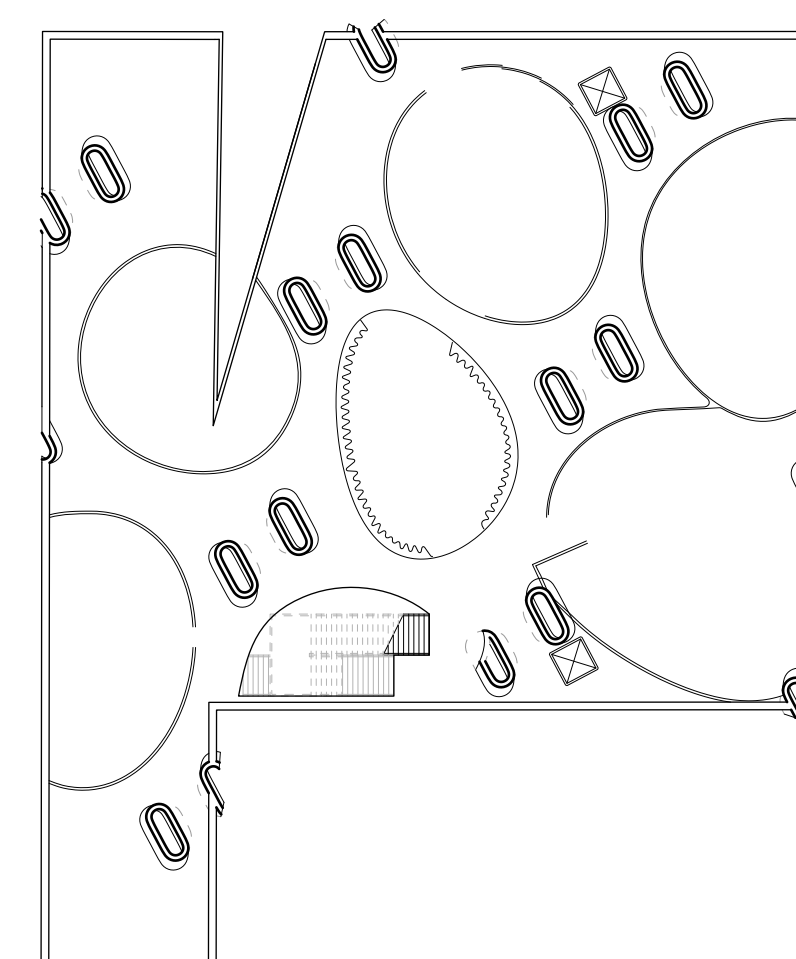

03

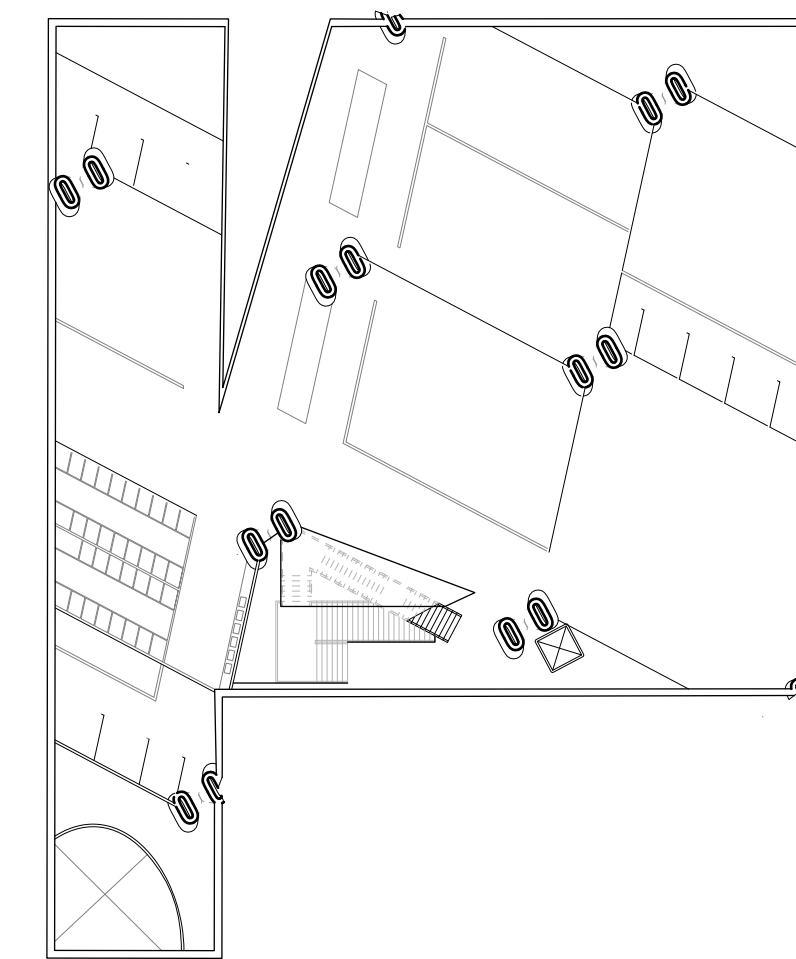

04

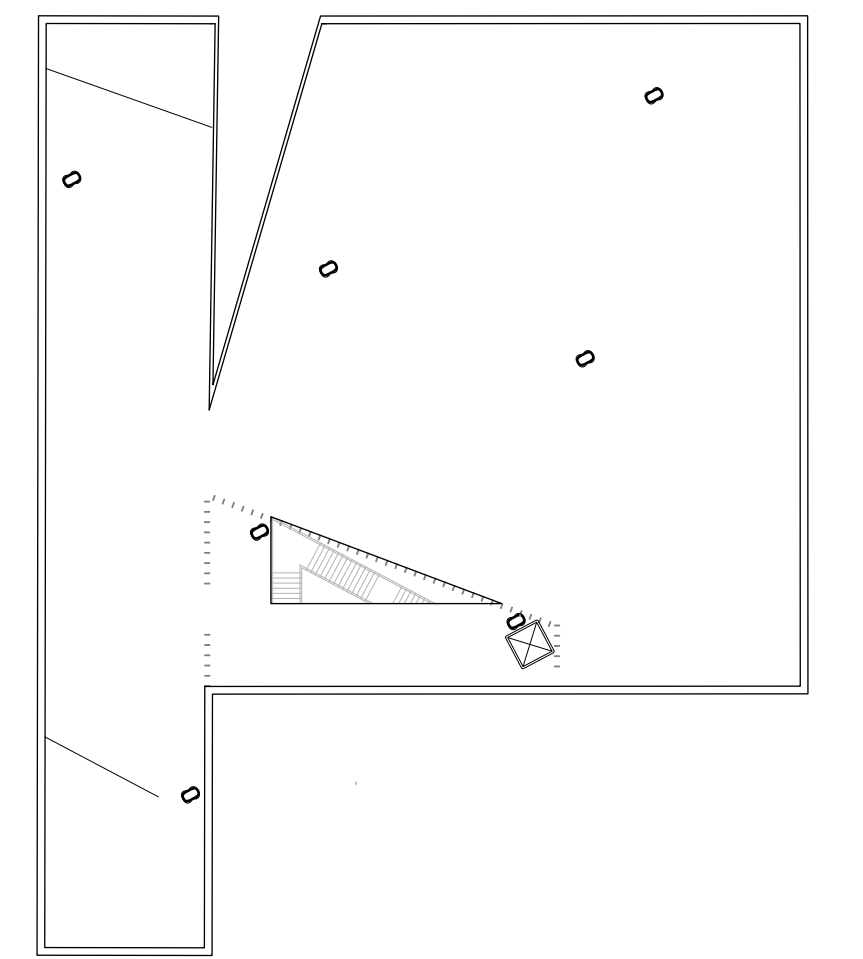

05



# CIRCULATION

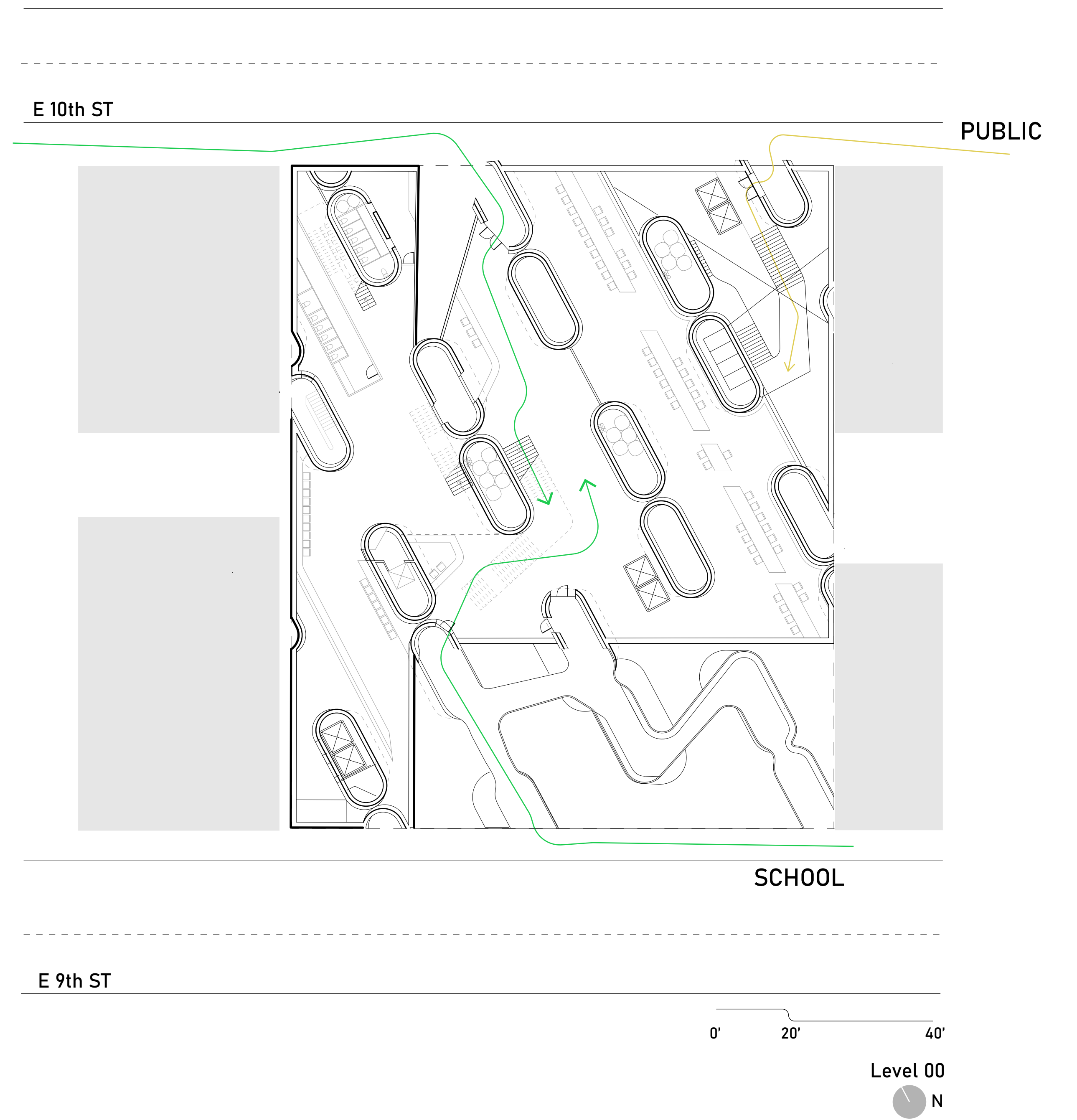
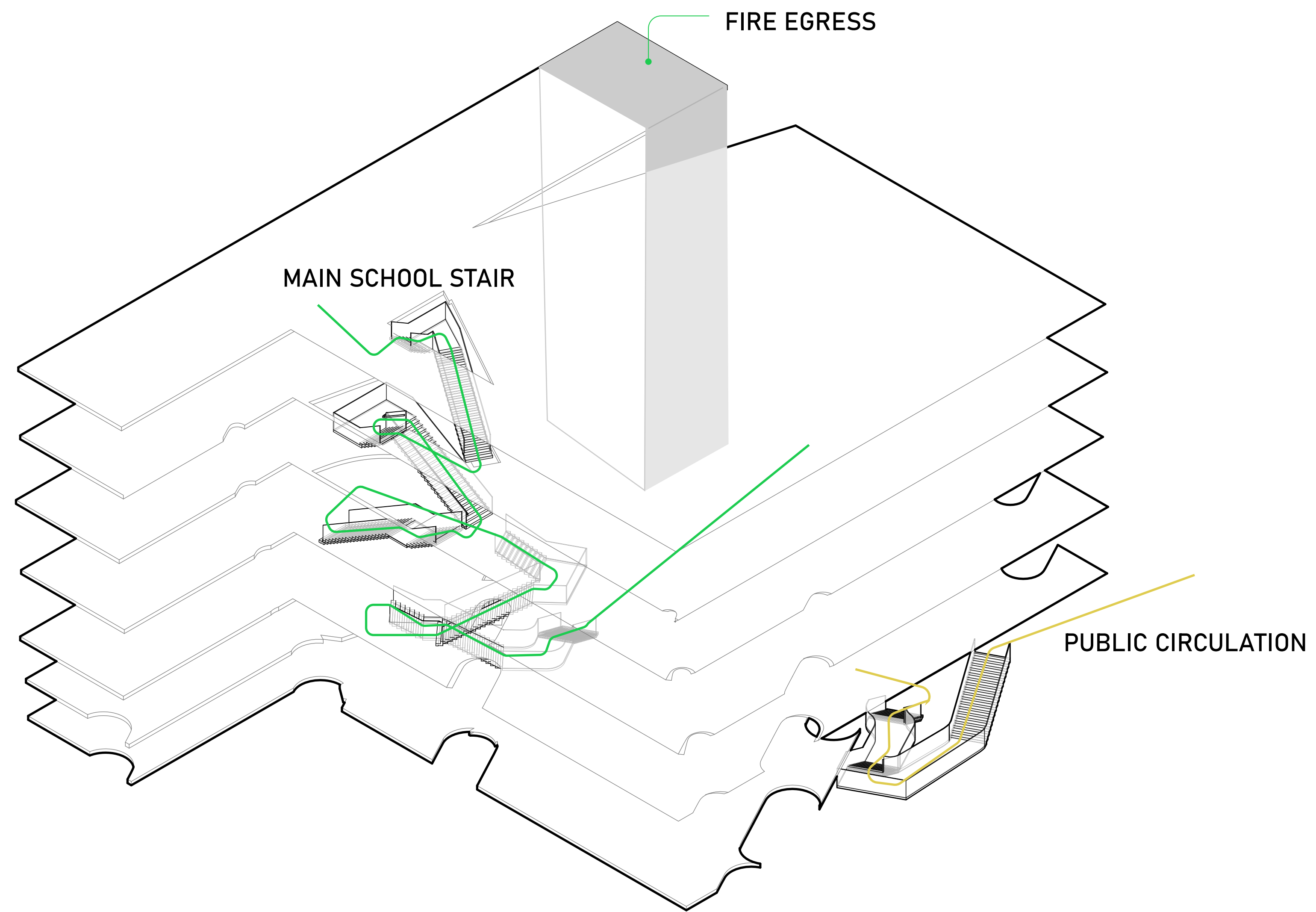



# STRUCTURE

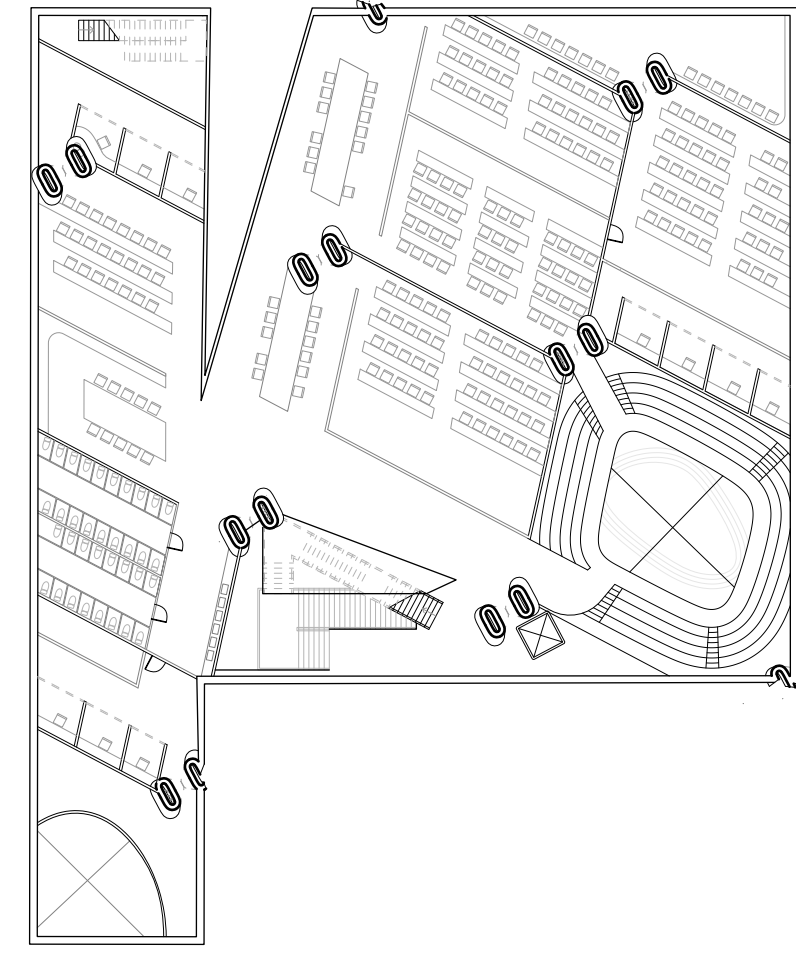
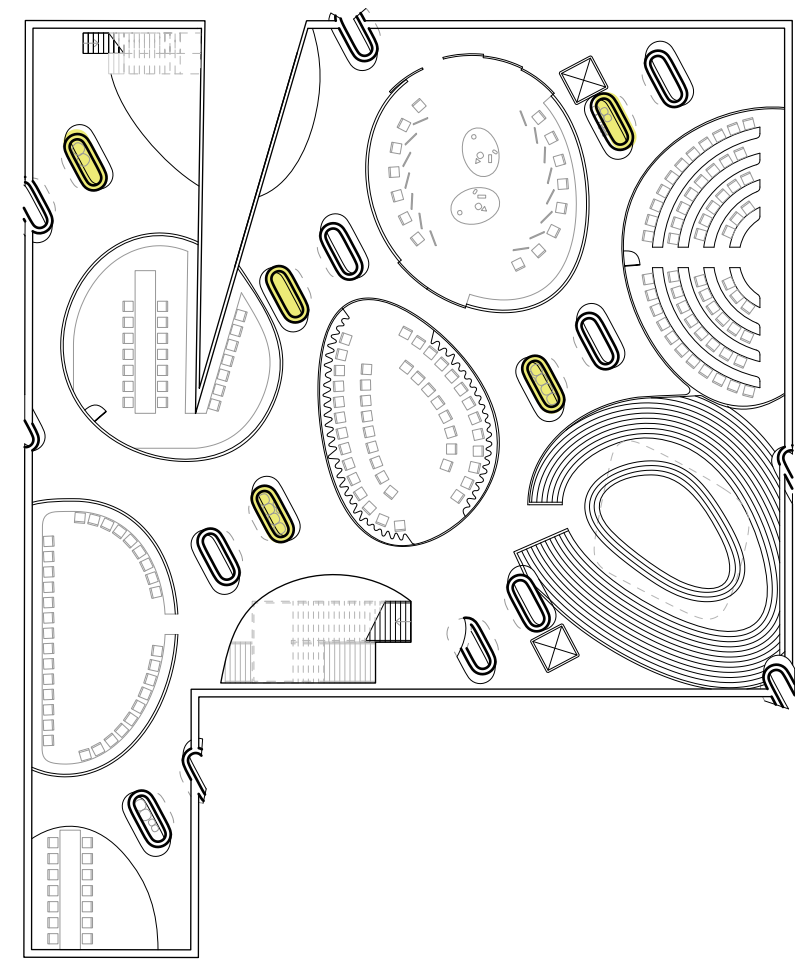
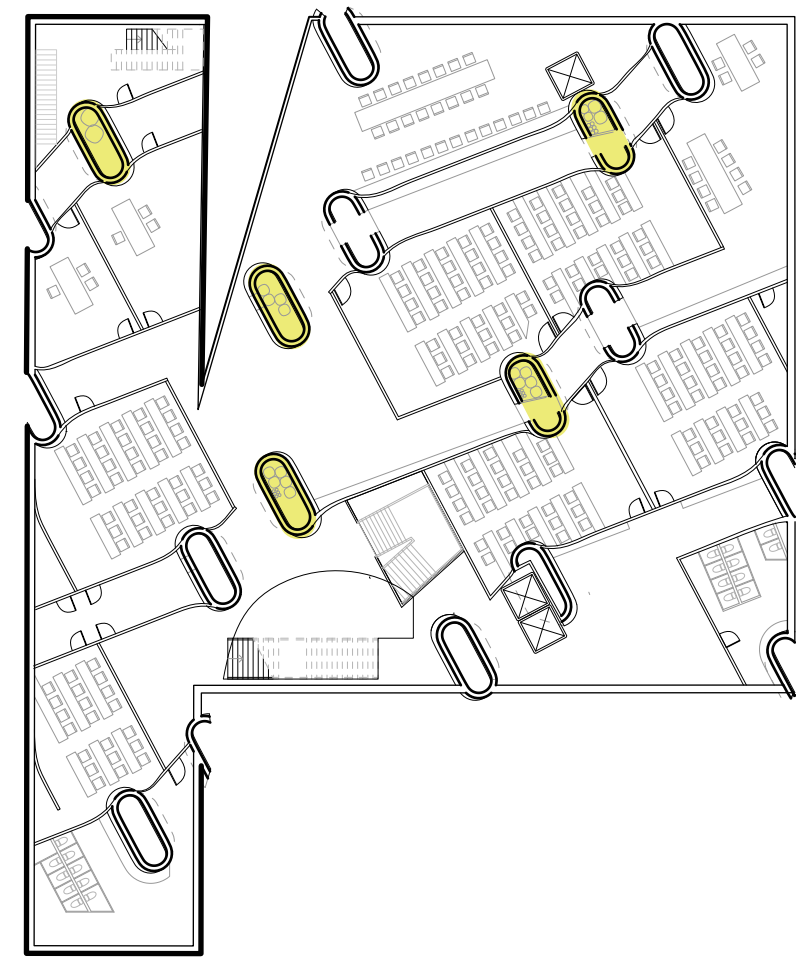
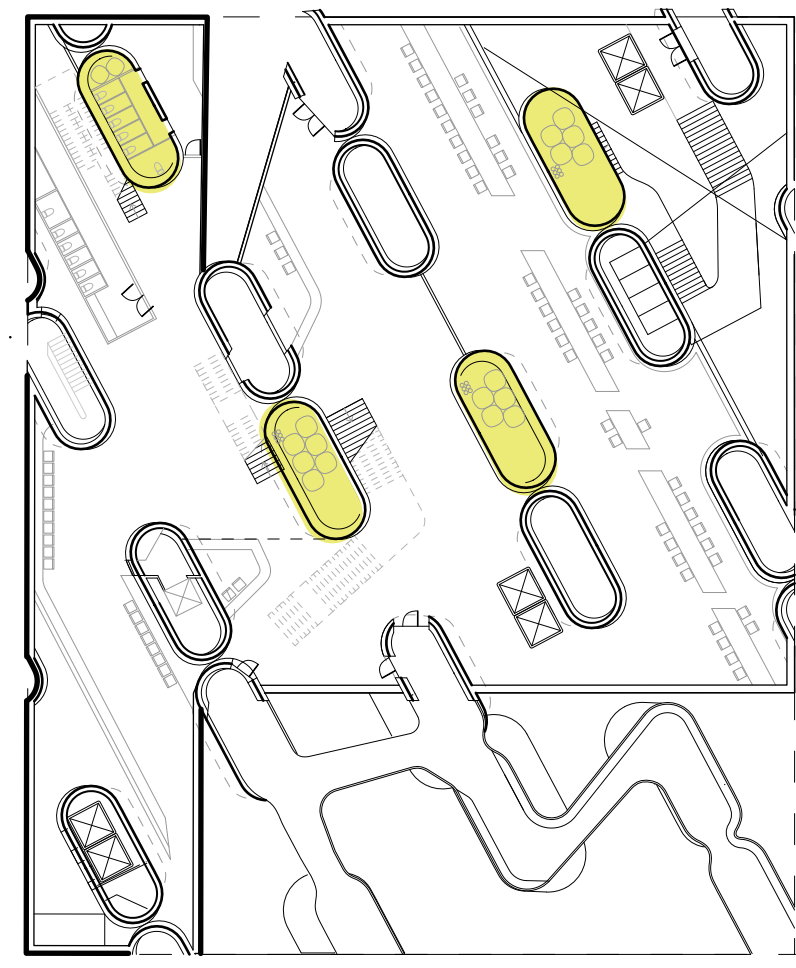
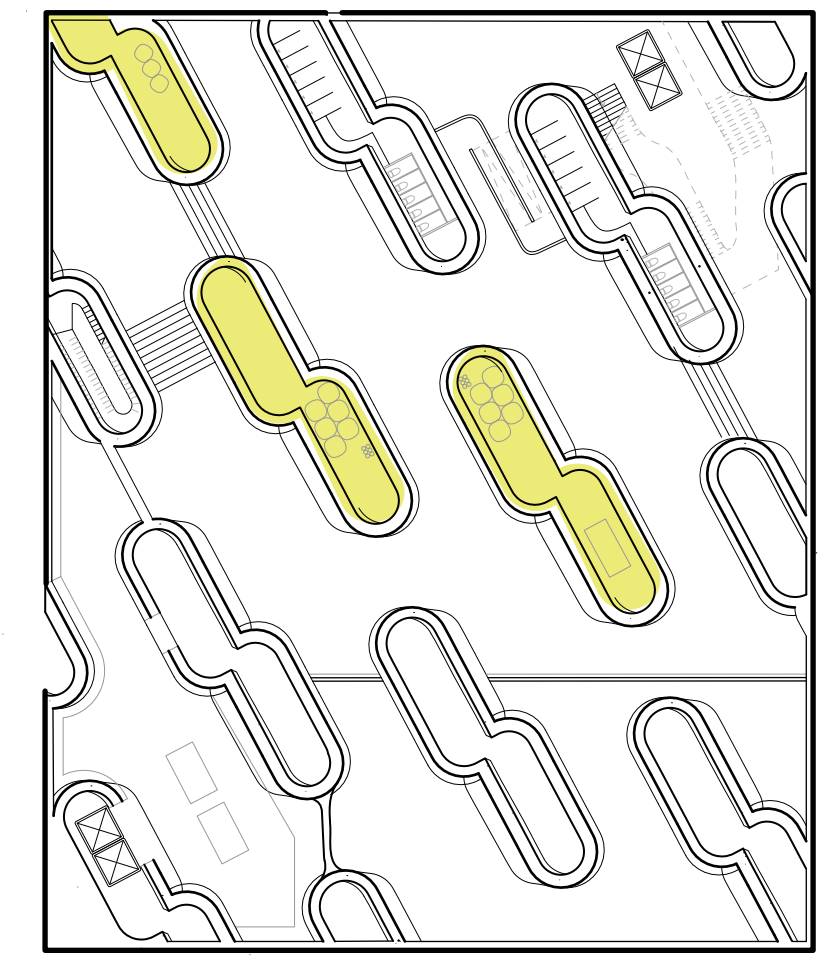
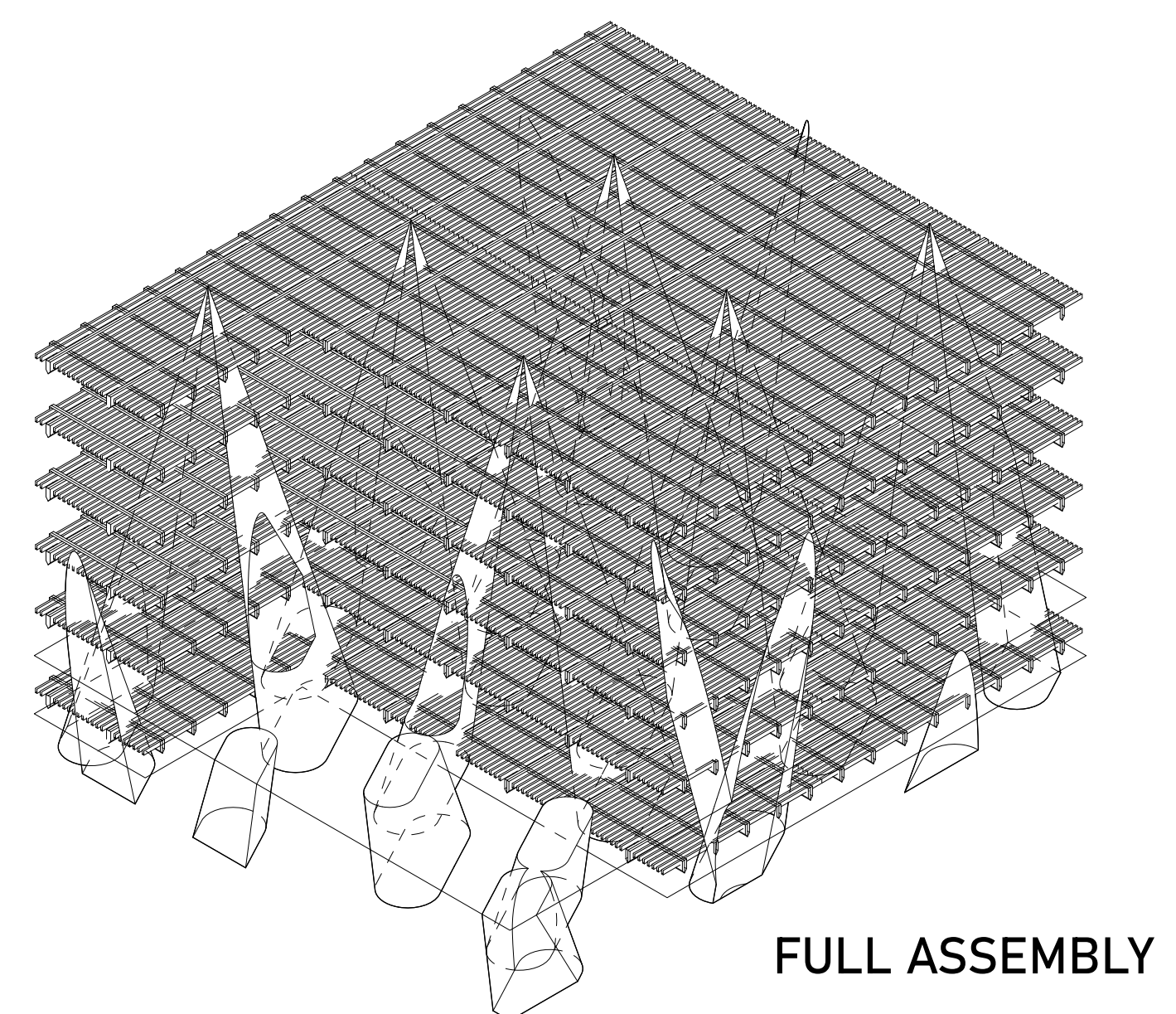
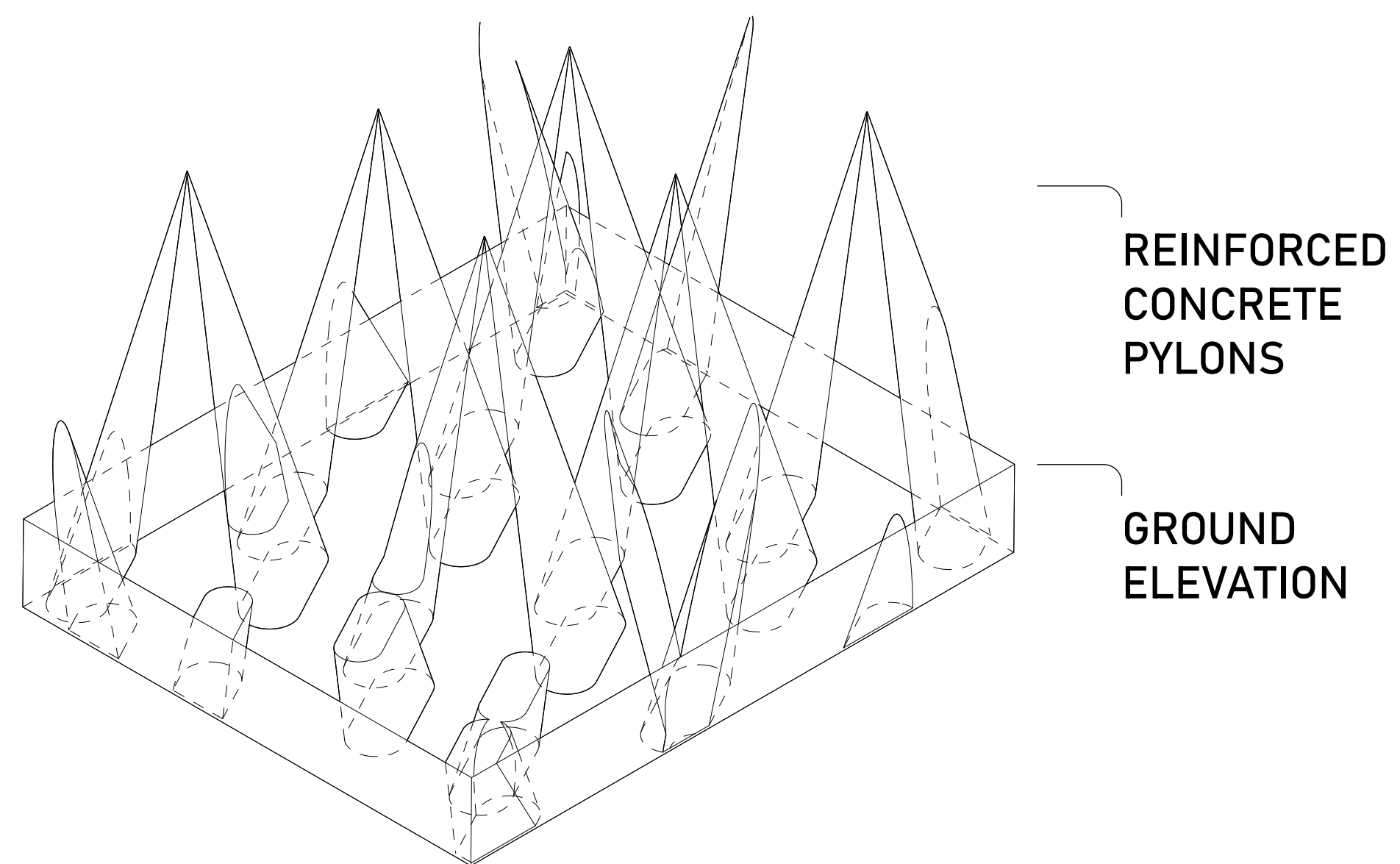
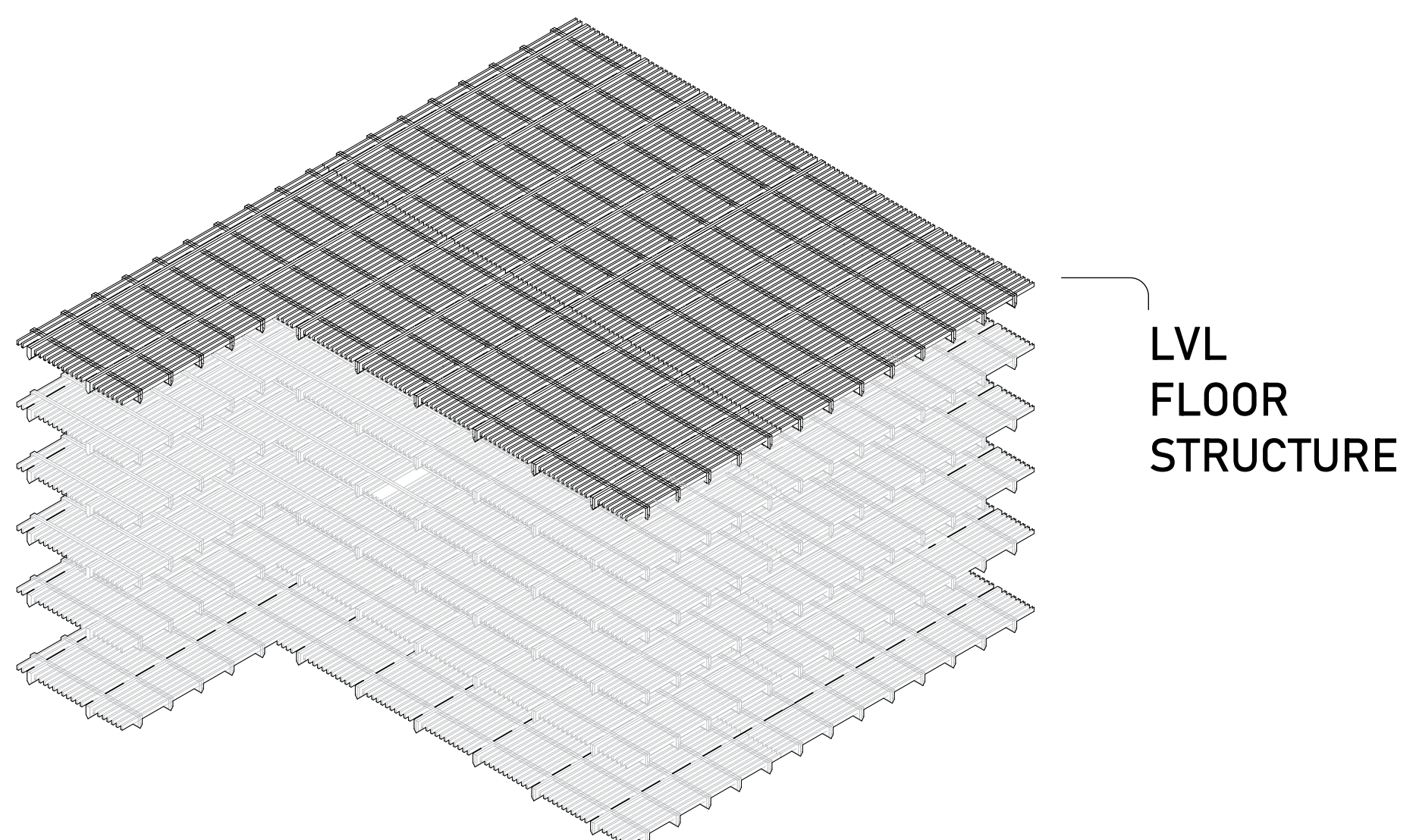

HVAC AND ELECTRICAL SHAFTS



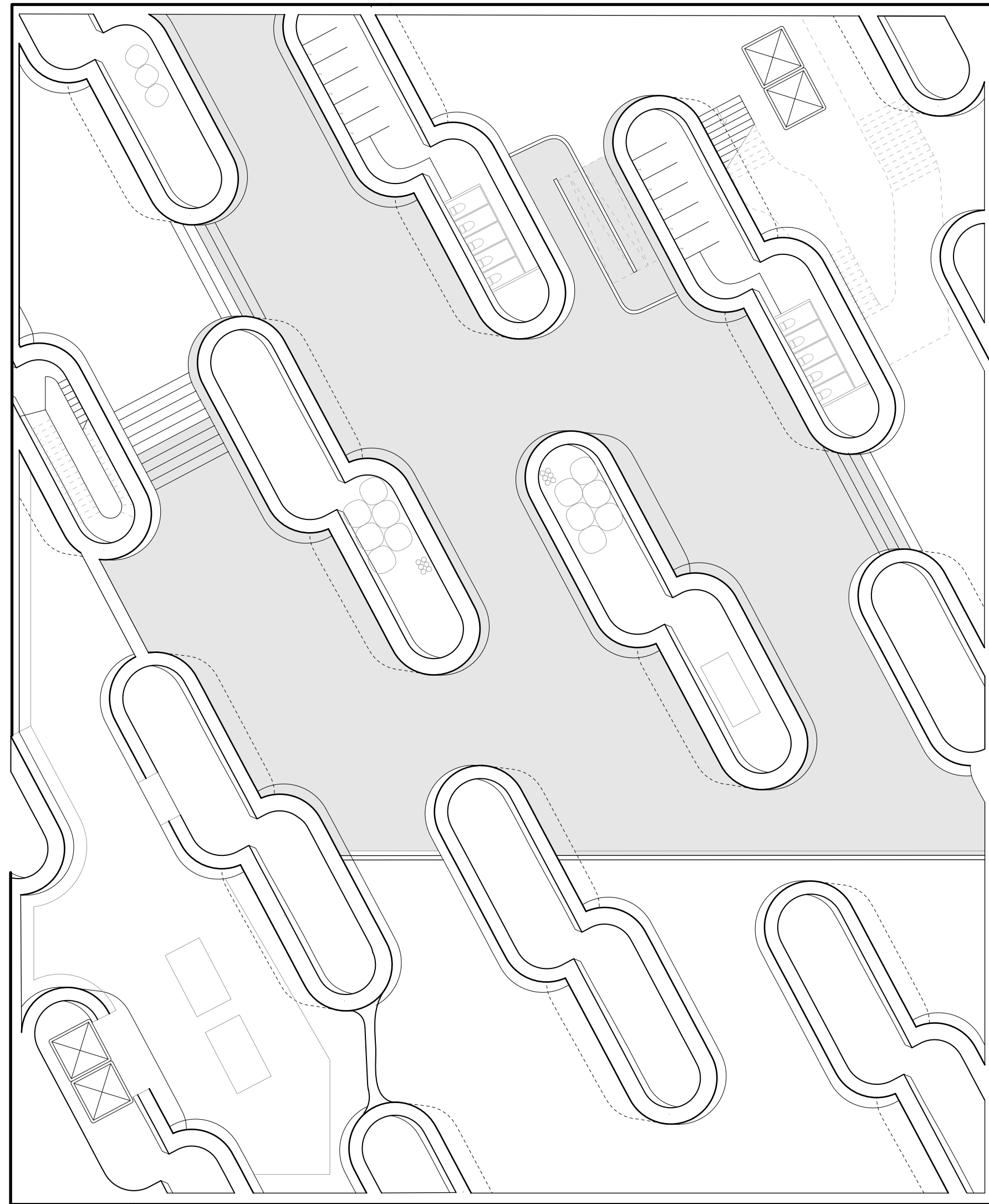

Level -01

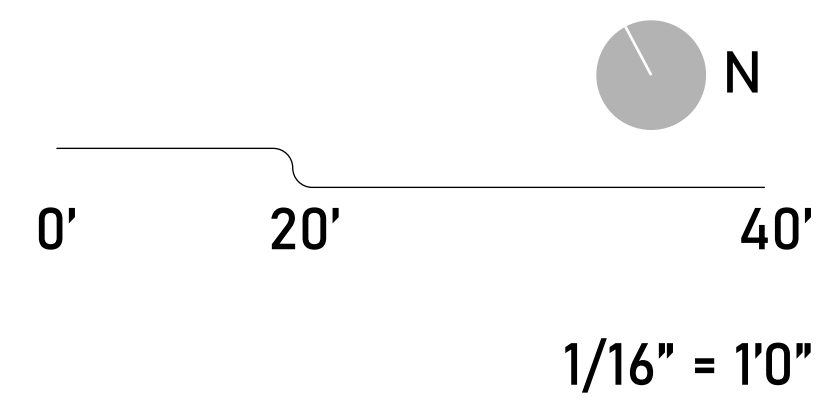

E 10th ST

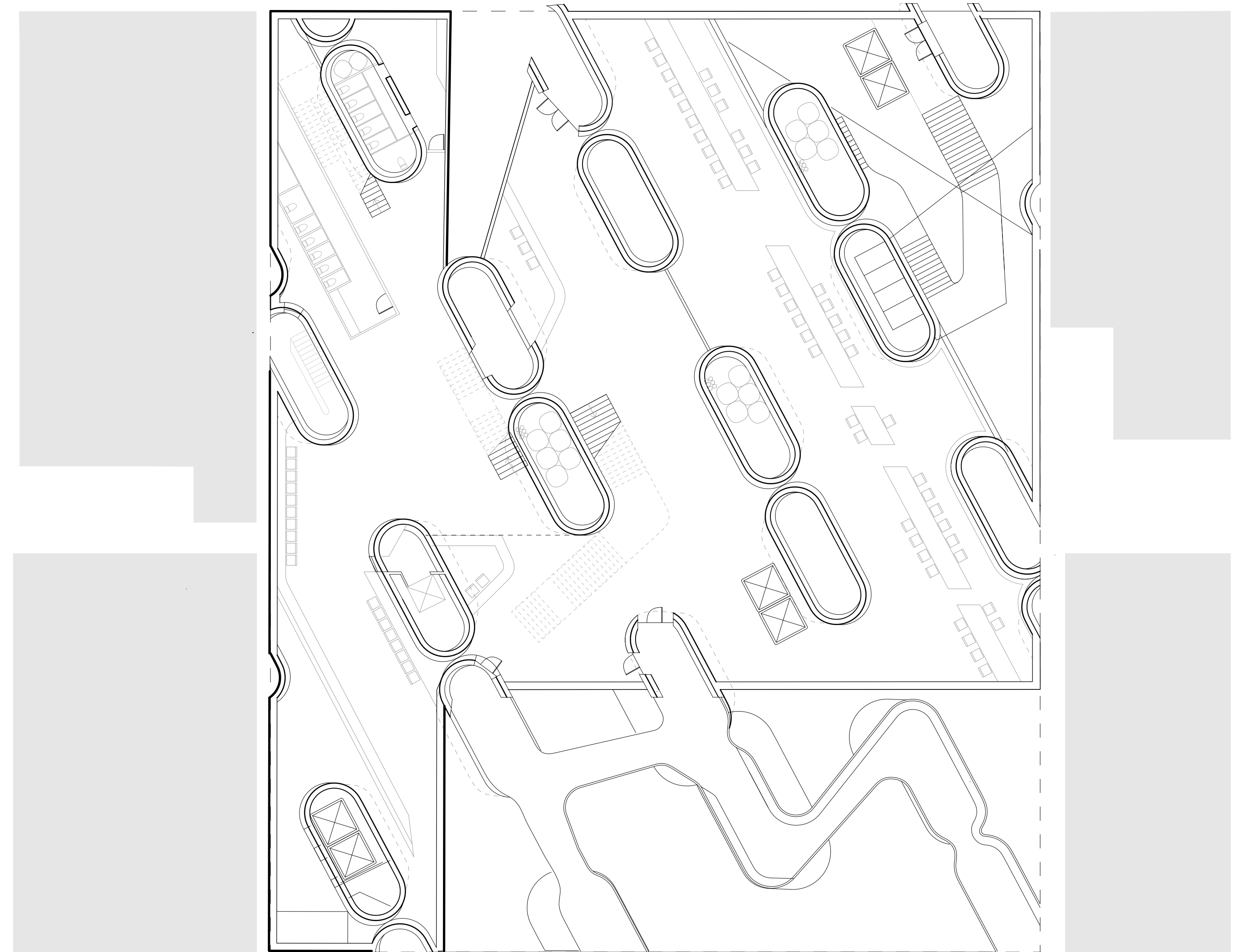

E 9th ST

Level 00

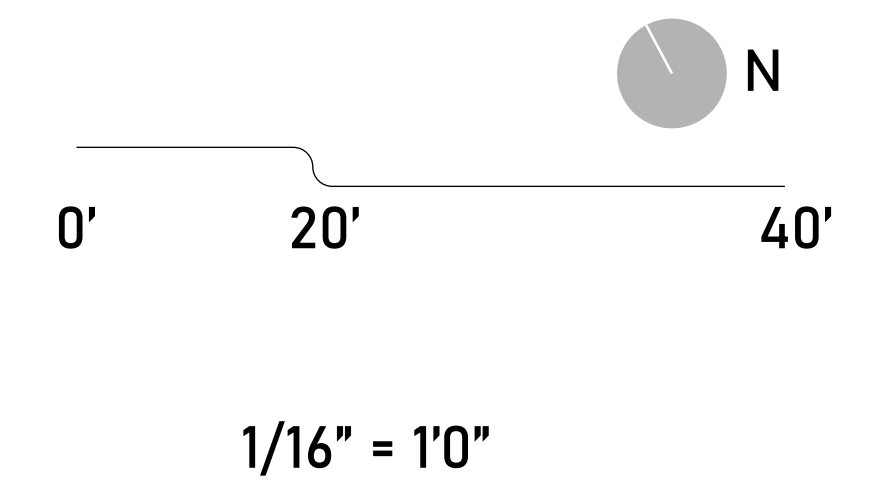



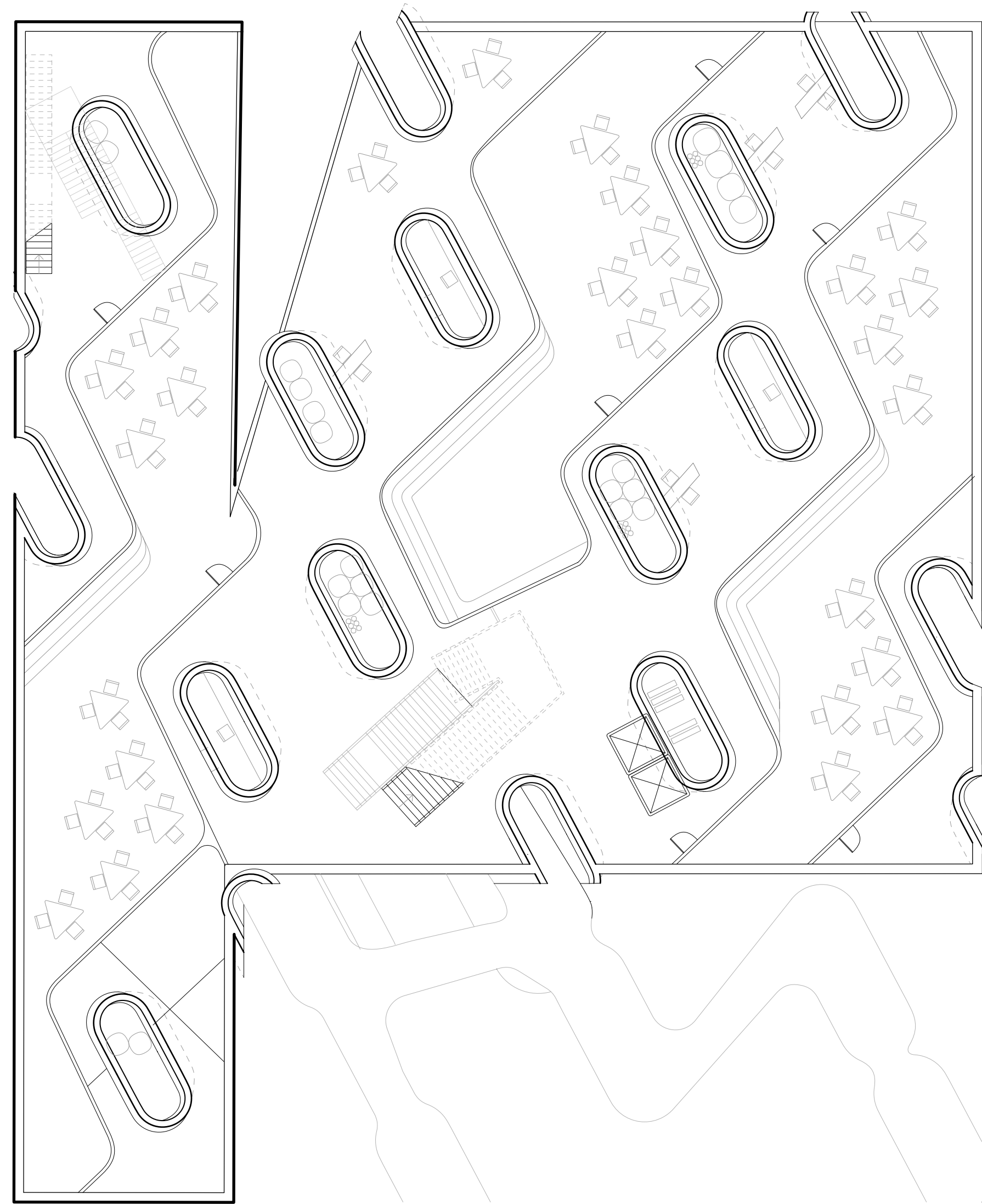

Level 01



0' 20' 40'

1/16" = 1'0"

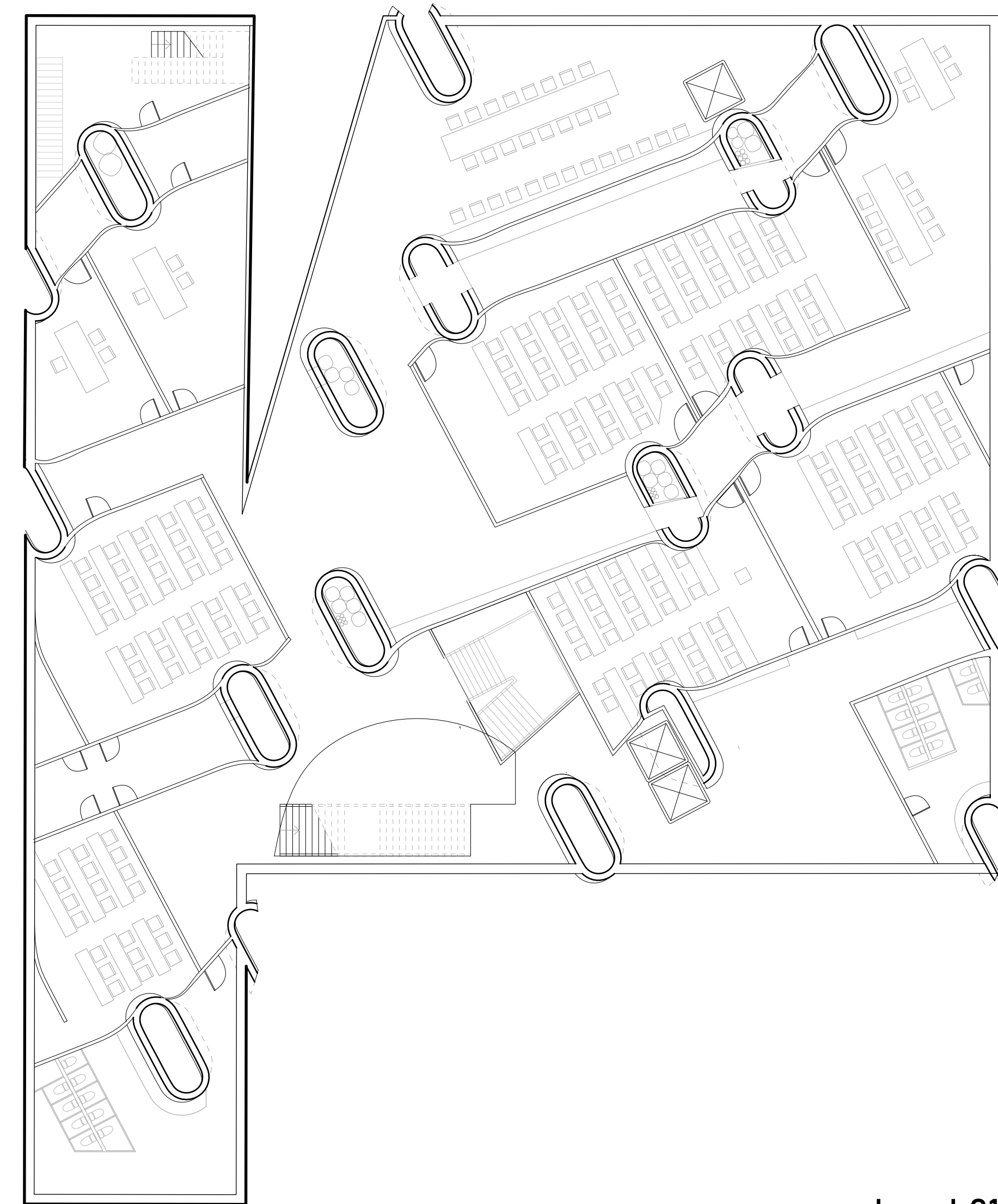

Level 01



0' 20' 40'

1/16" = 1'0"



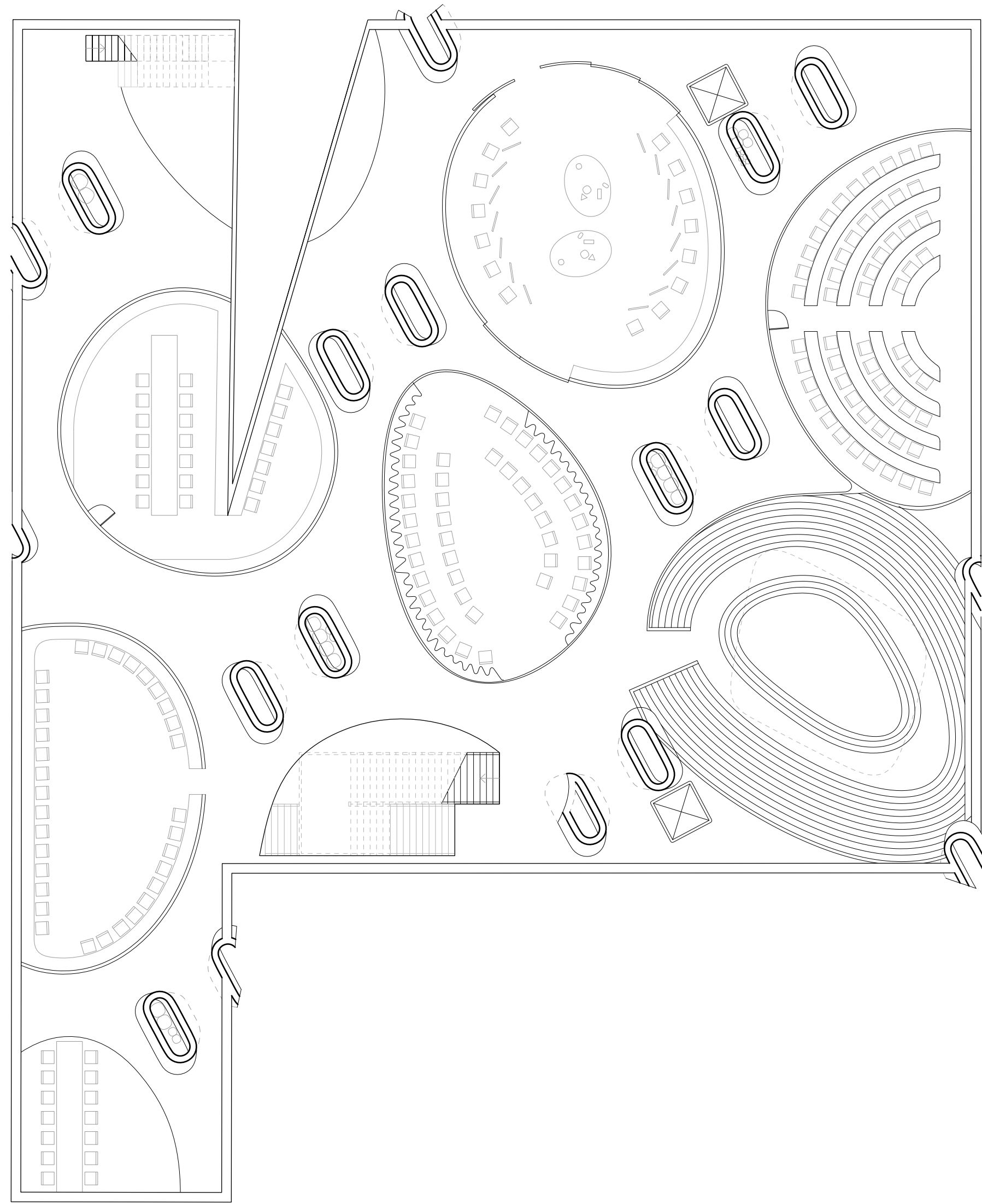

Level 03



0' 20' 40'

1/16" = 1'0"

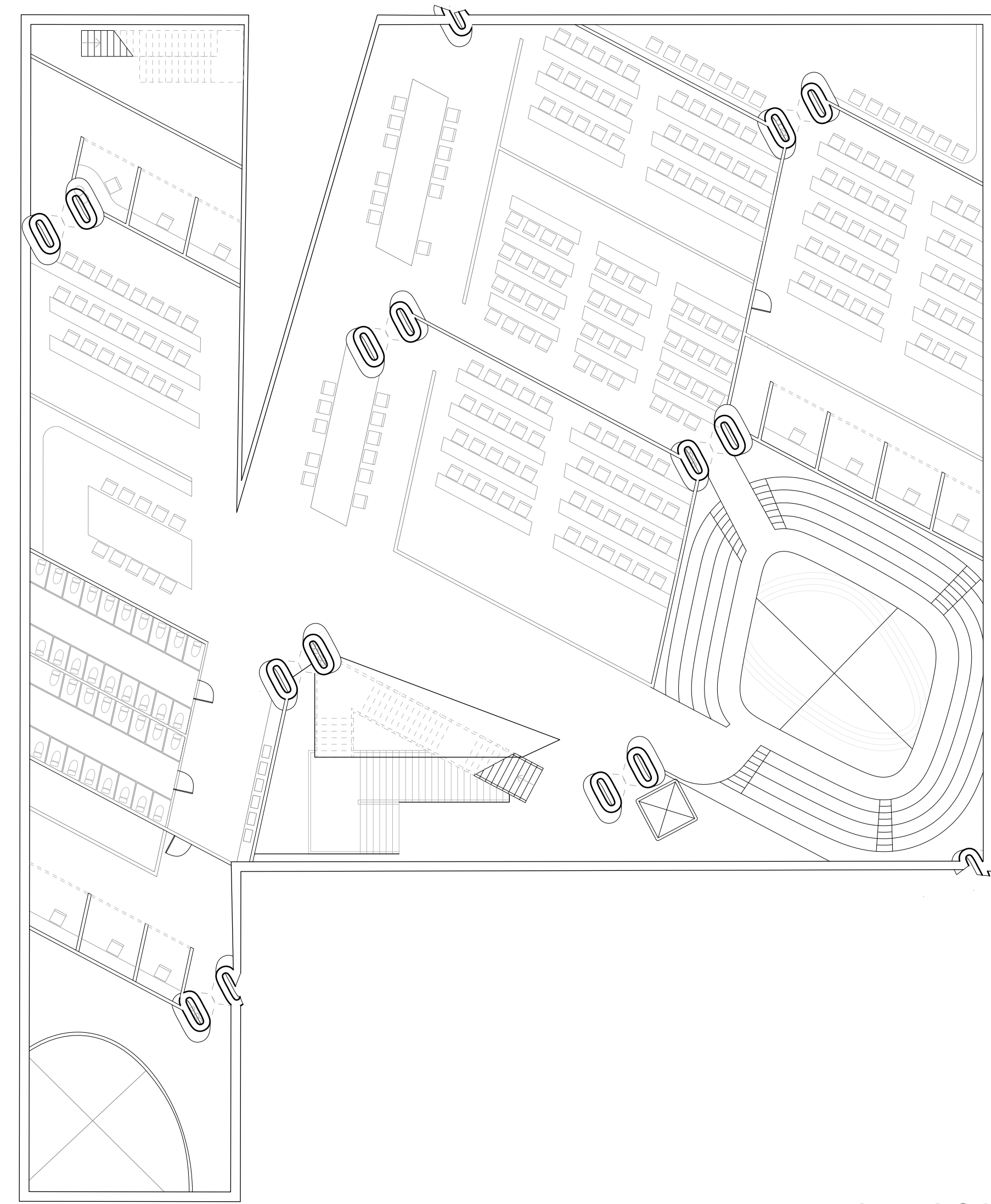

Level 04



0' 20' 40'

1/16" = 1'0"



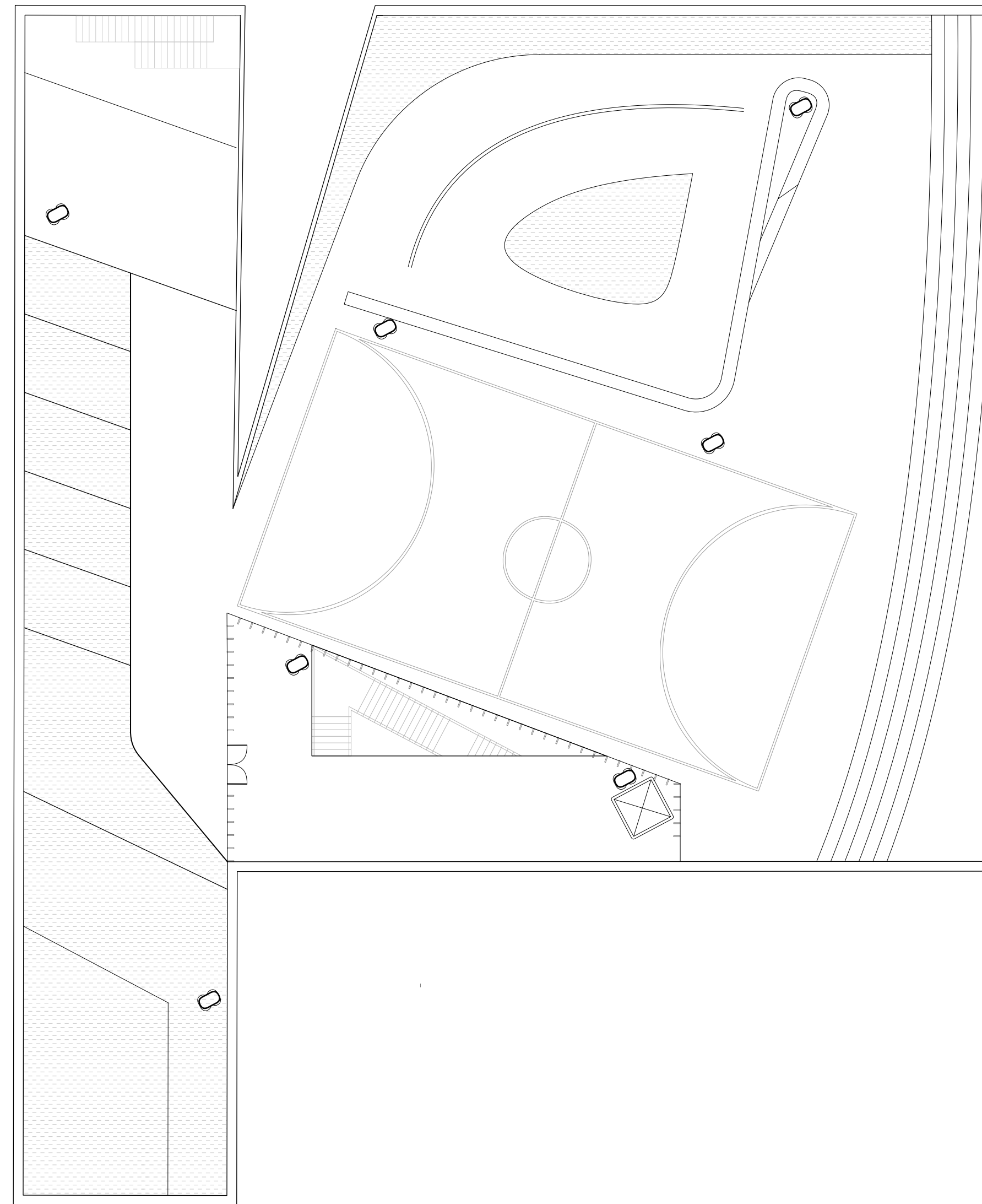

Level 05\_Rooftop

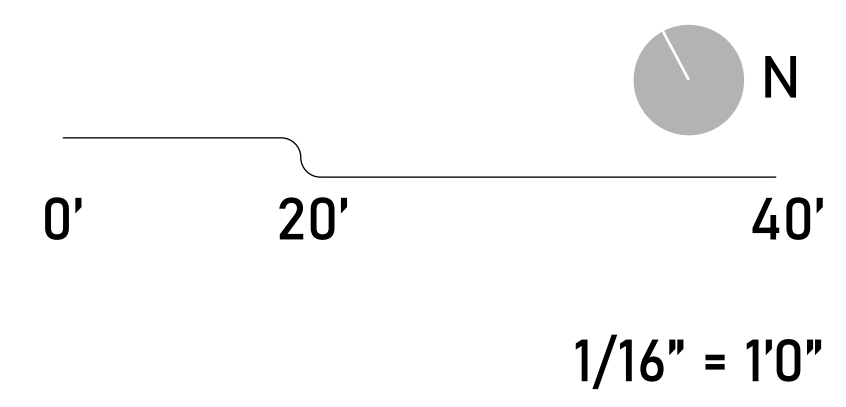



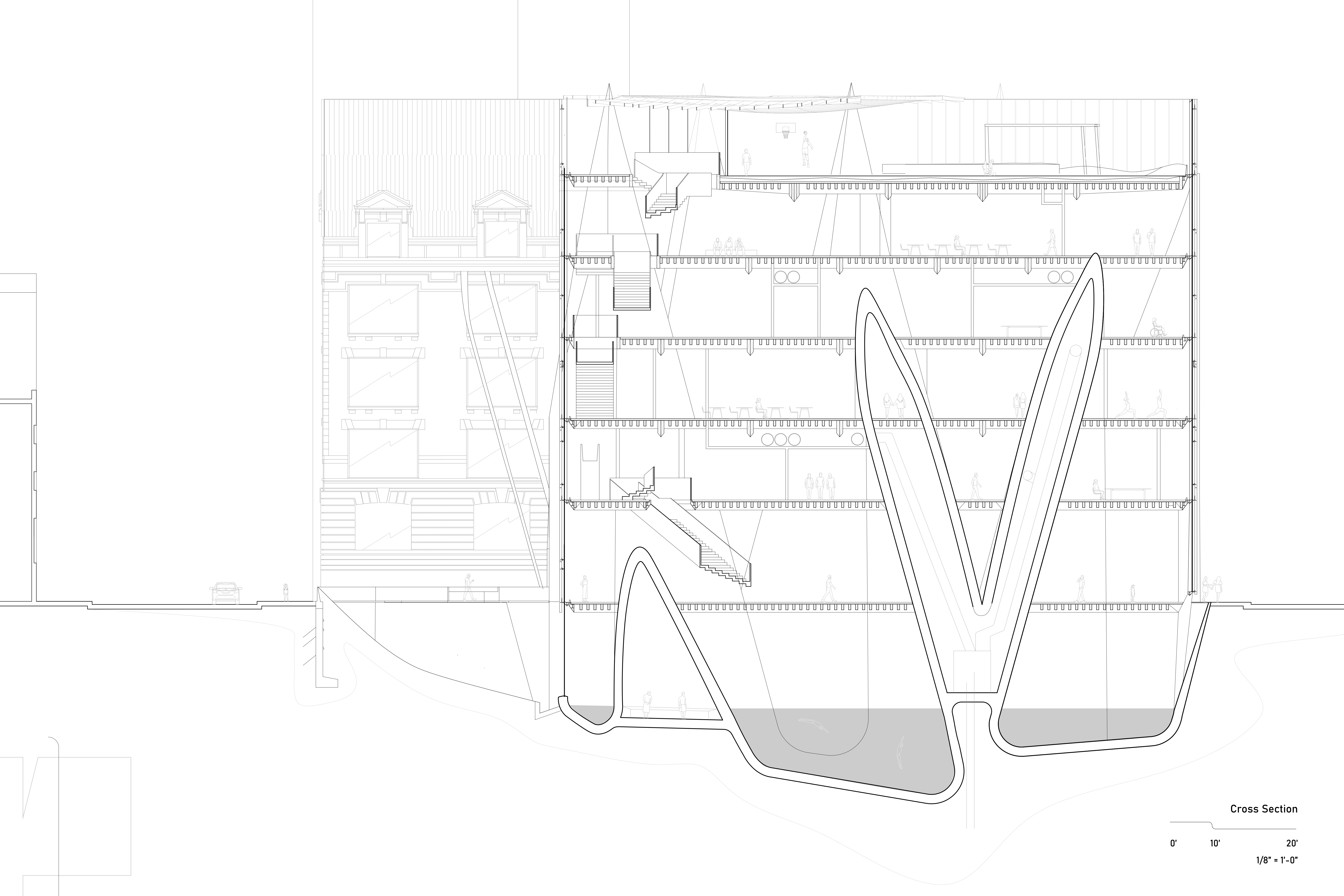

Cross Section

0' 10' 20'  
1/8" = 1'-0"



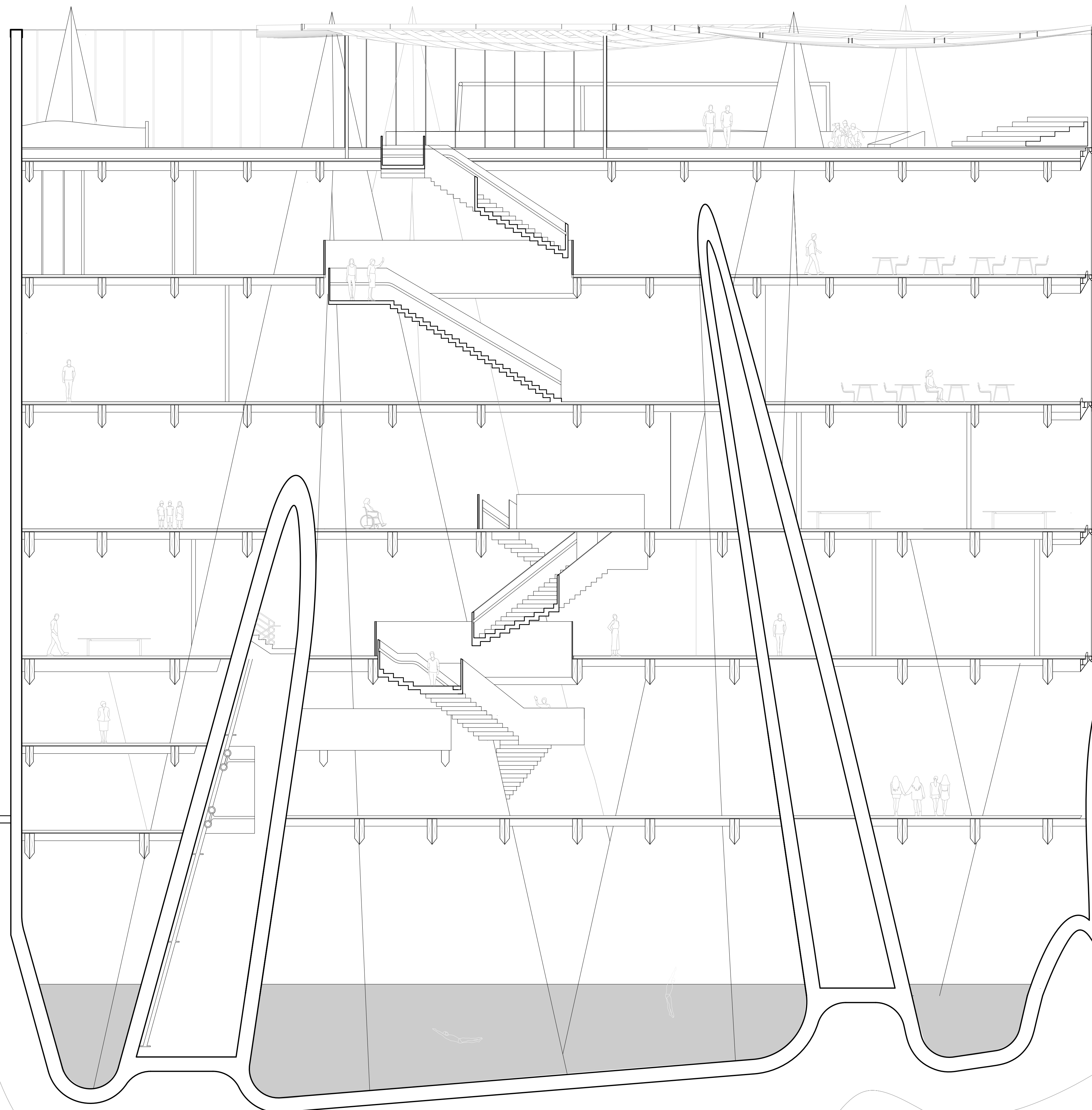

Longitudinal Section

0' 10' 20'  
1/8" = 1'-0"



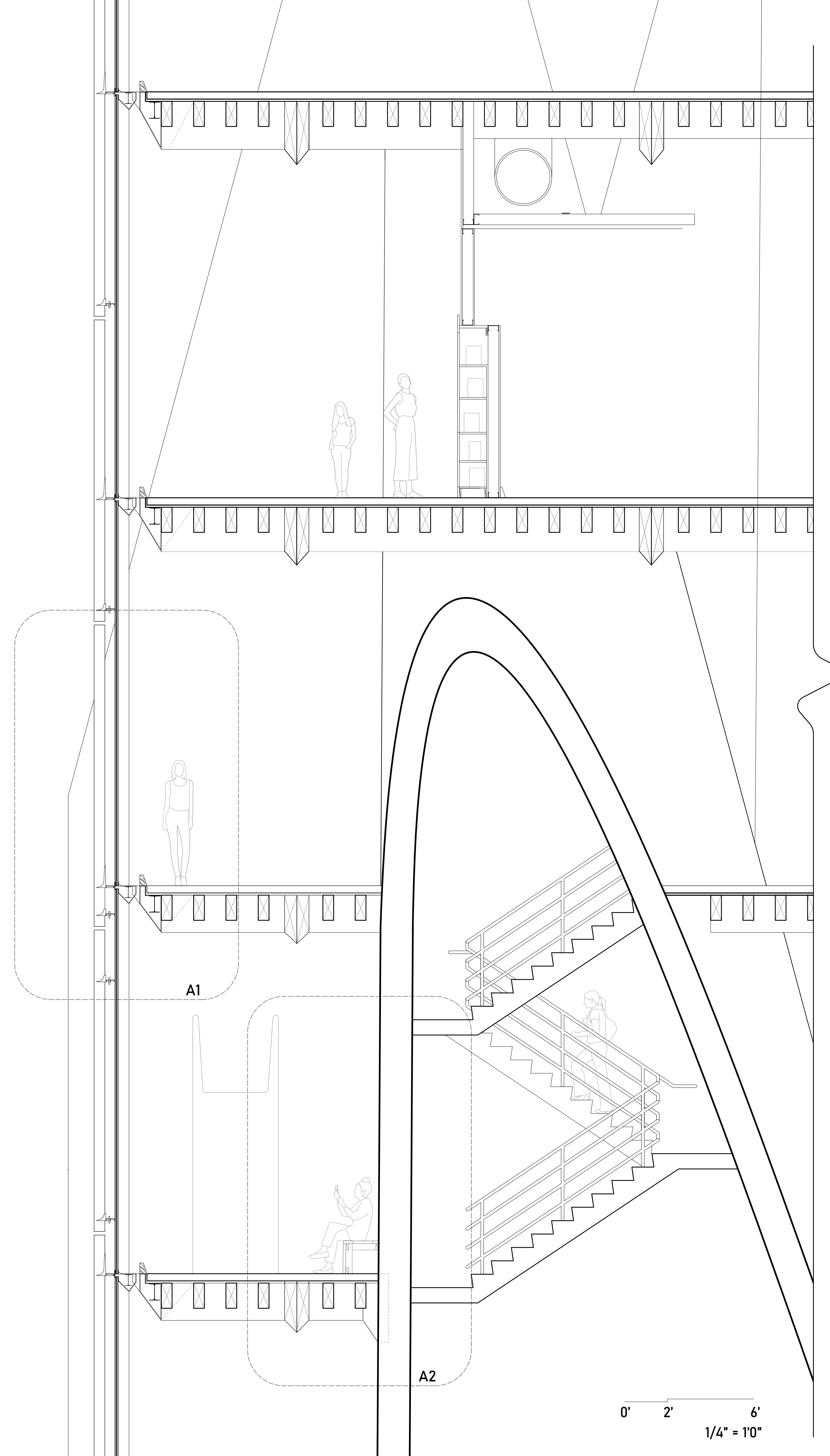

0' 2' 6'  
1/4" = 10"



