

# SITE ANALYSIS

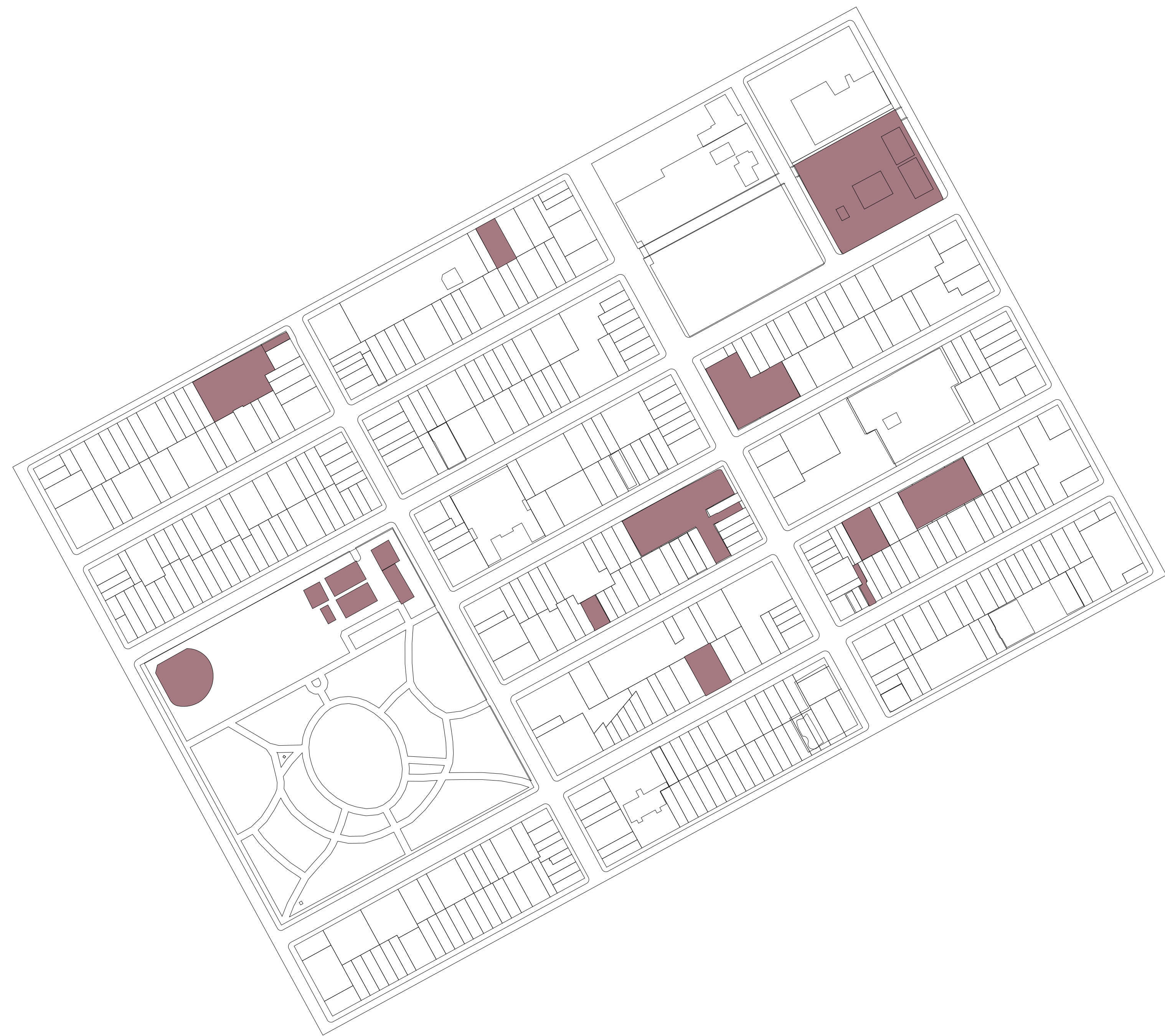

Green Space



high-rise buildings (>80ft)

# CIRCULATION

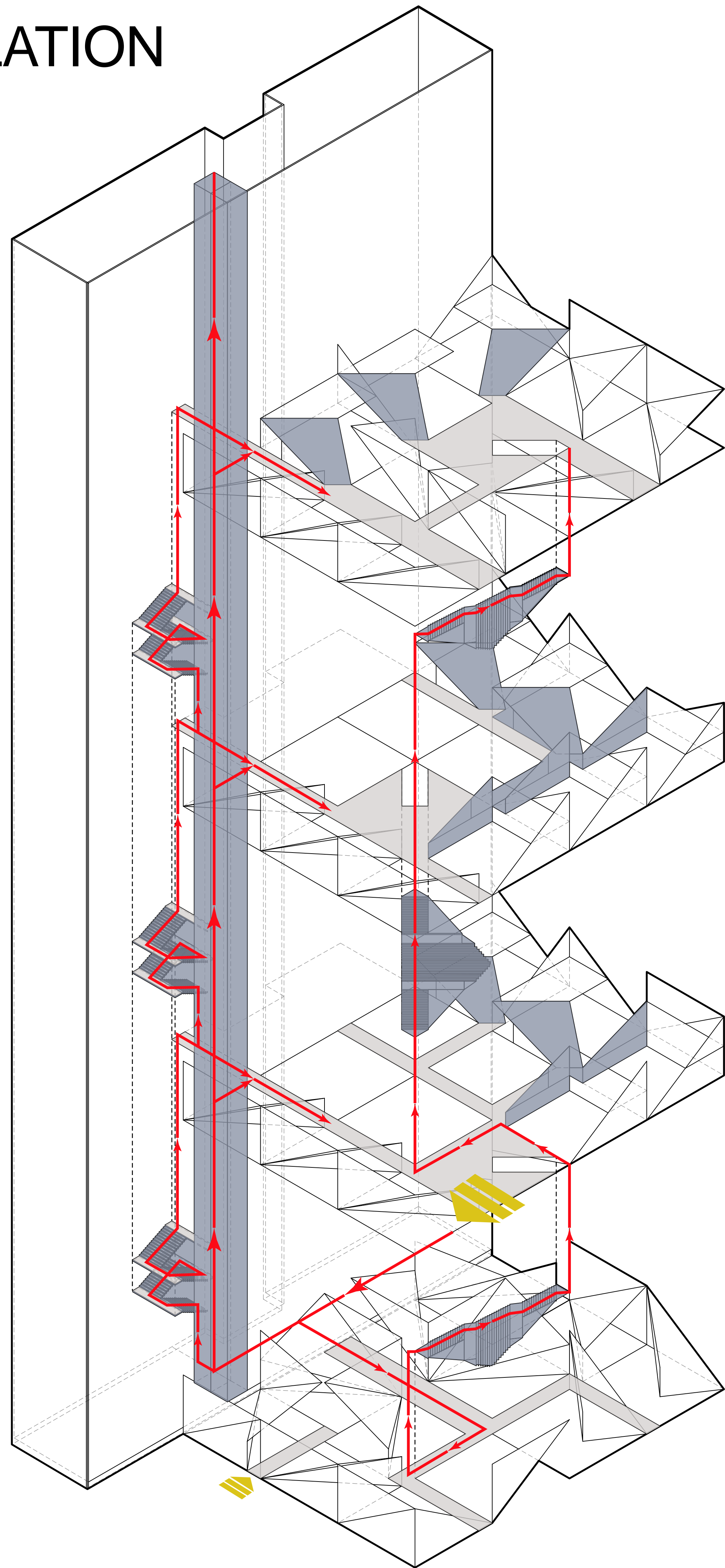

# CONCEPT

## Basic Units



primary part - dark grey concrete

secondary part - light grey concrete

## Aggregate

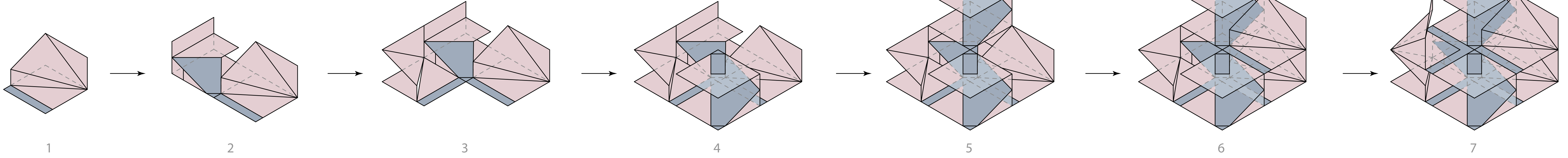

## Isolated Spaces

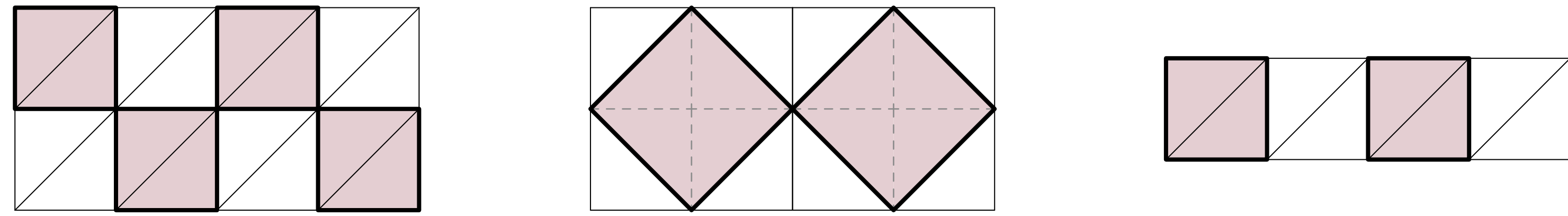

## Connective Spaces

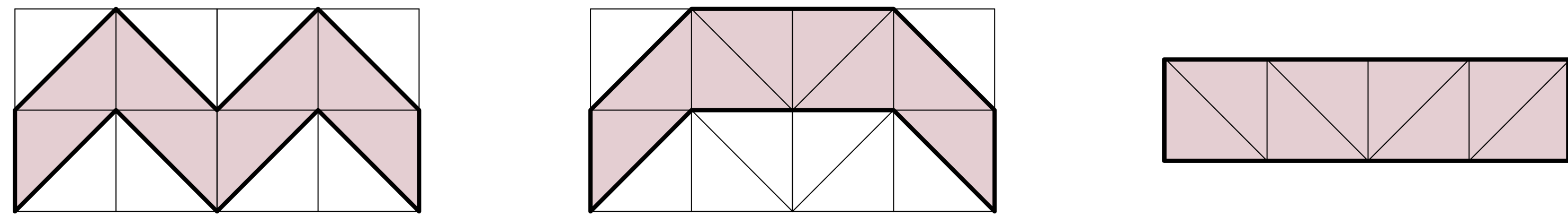

## Combination

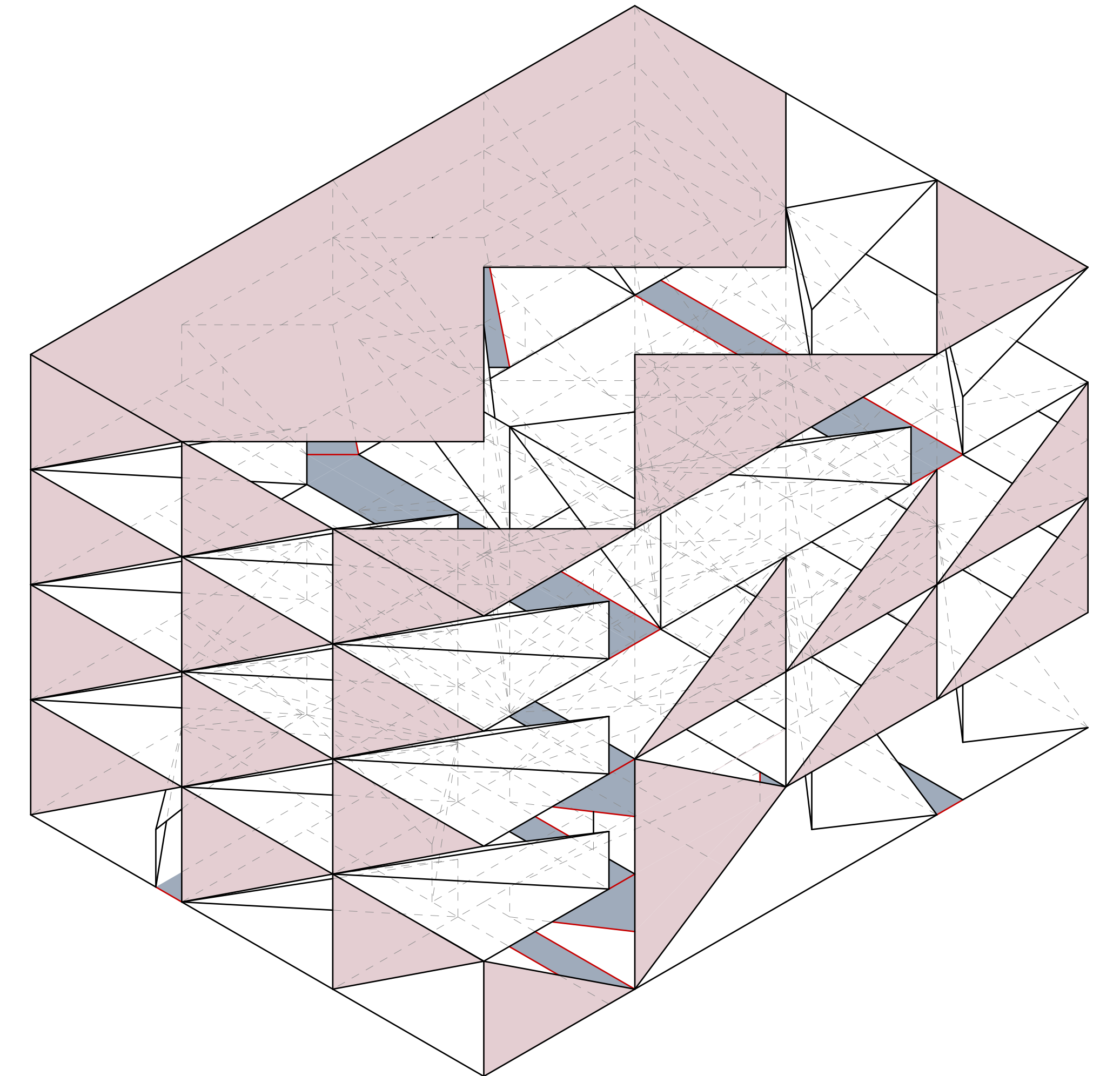
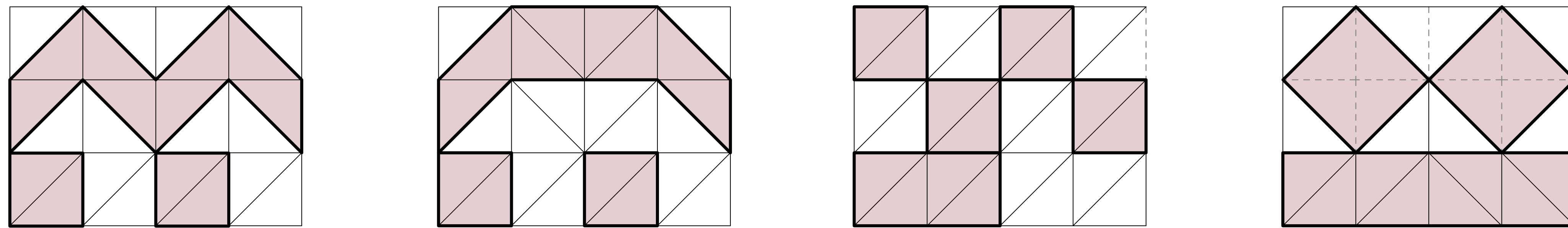

# PROGRAM

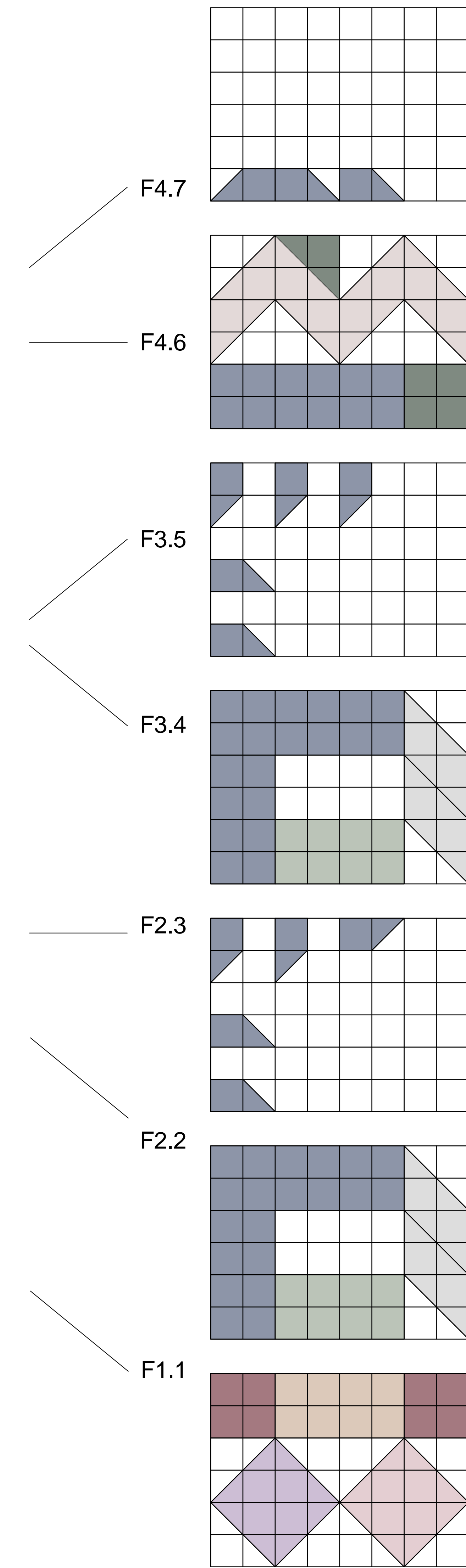
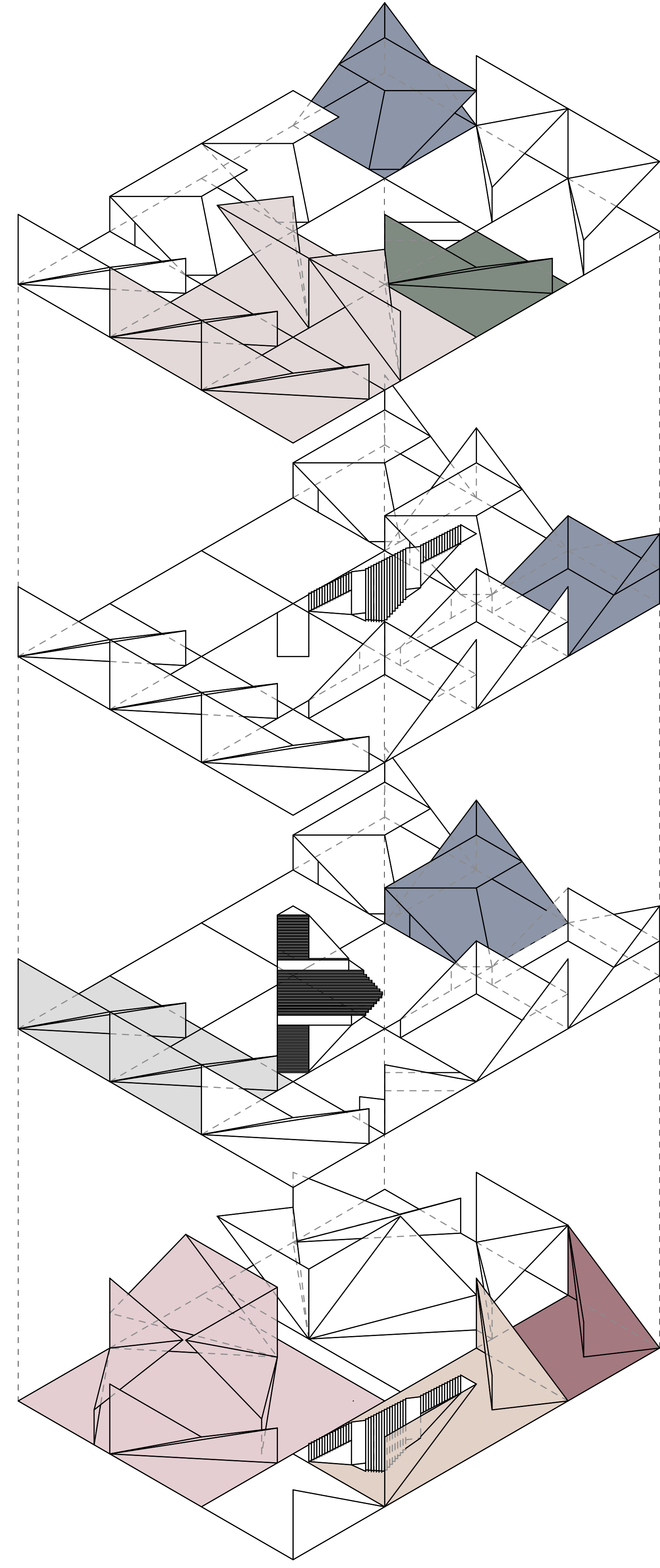
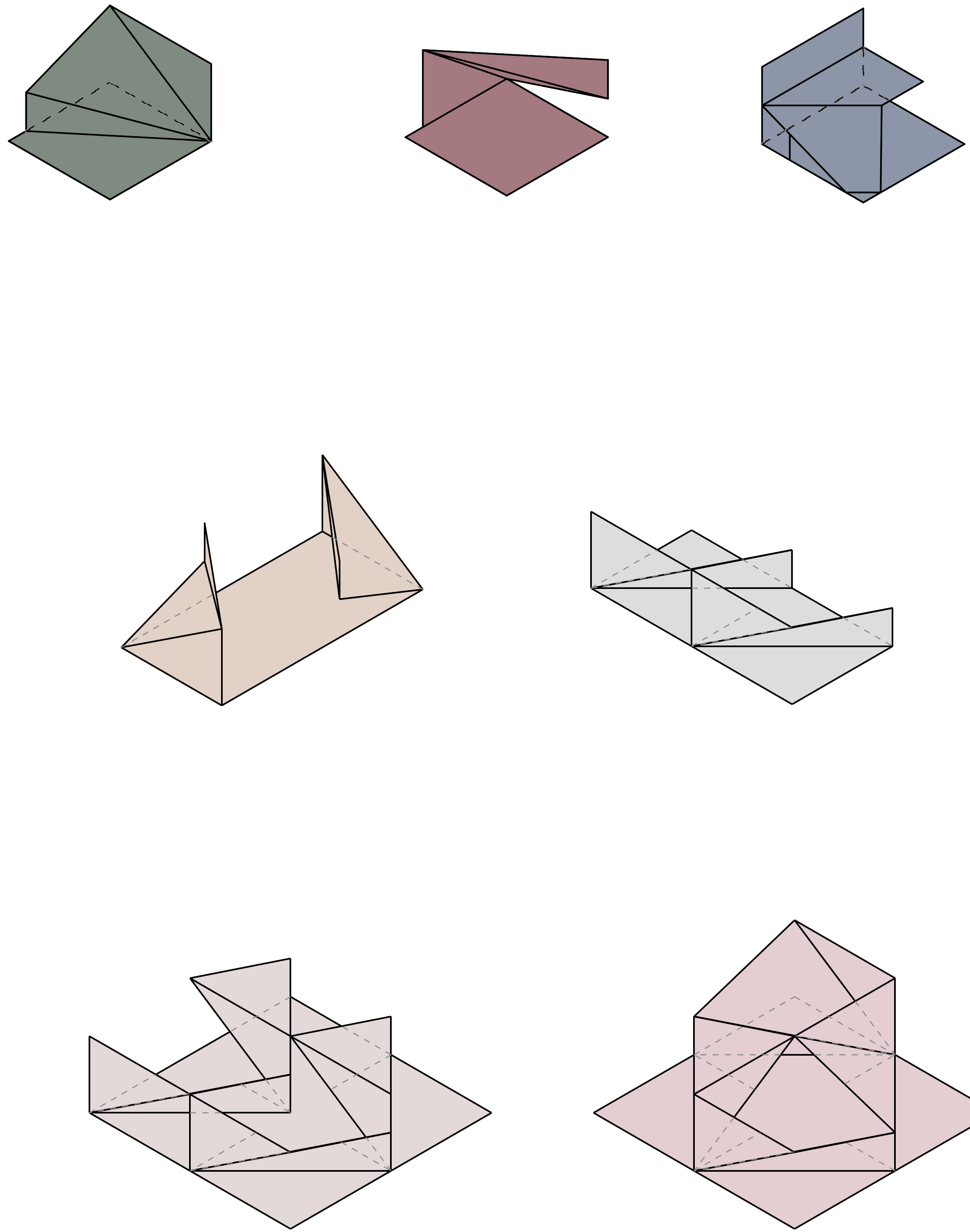

- scientific area
- resting area
- classroom
- multi-function classroom
- playground
- studio
- dining&library area
- auditorium
- gymnasium



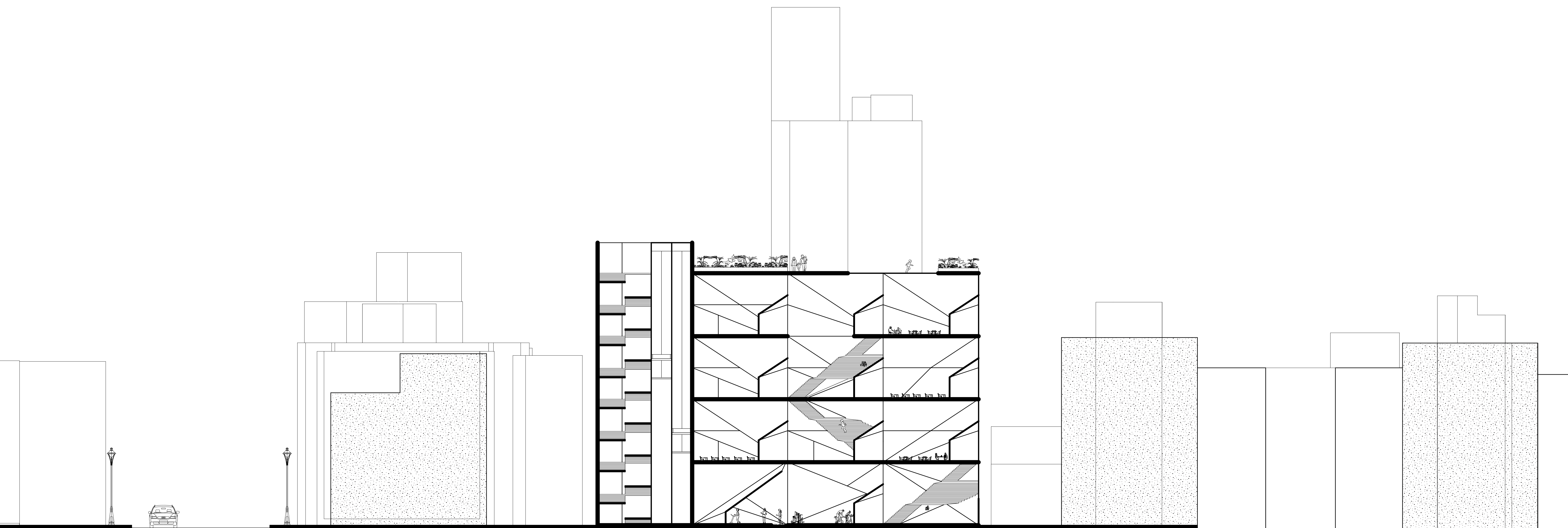

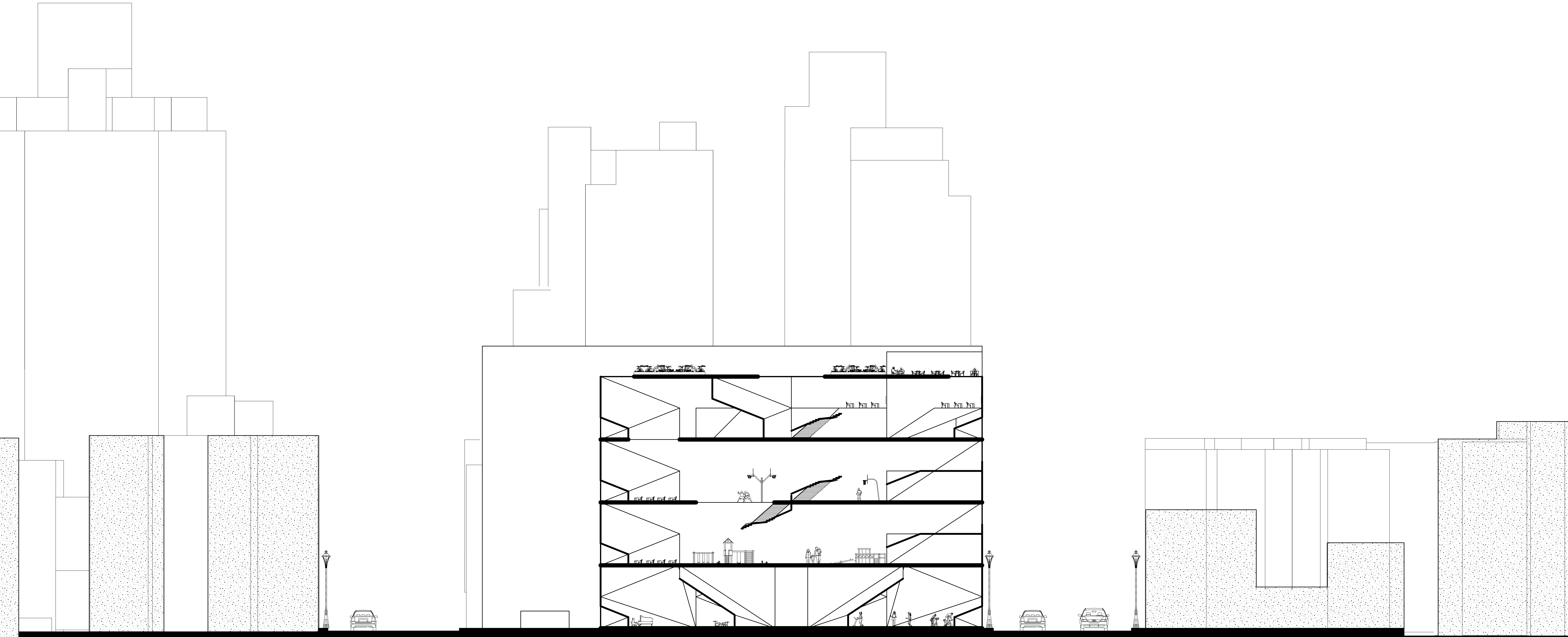

PLAN 1/8"

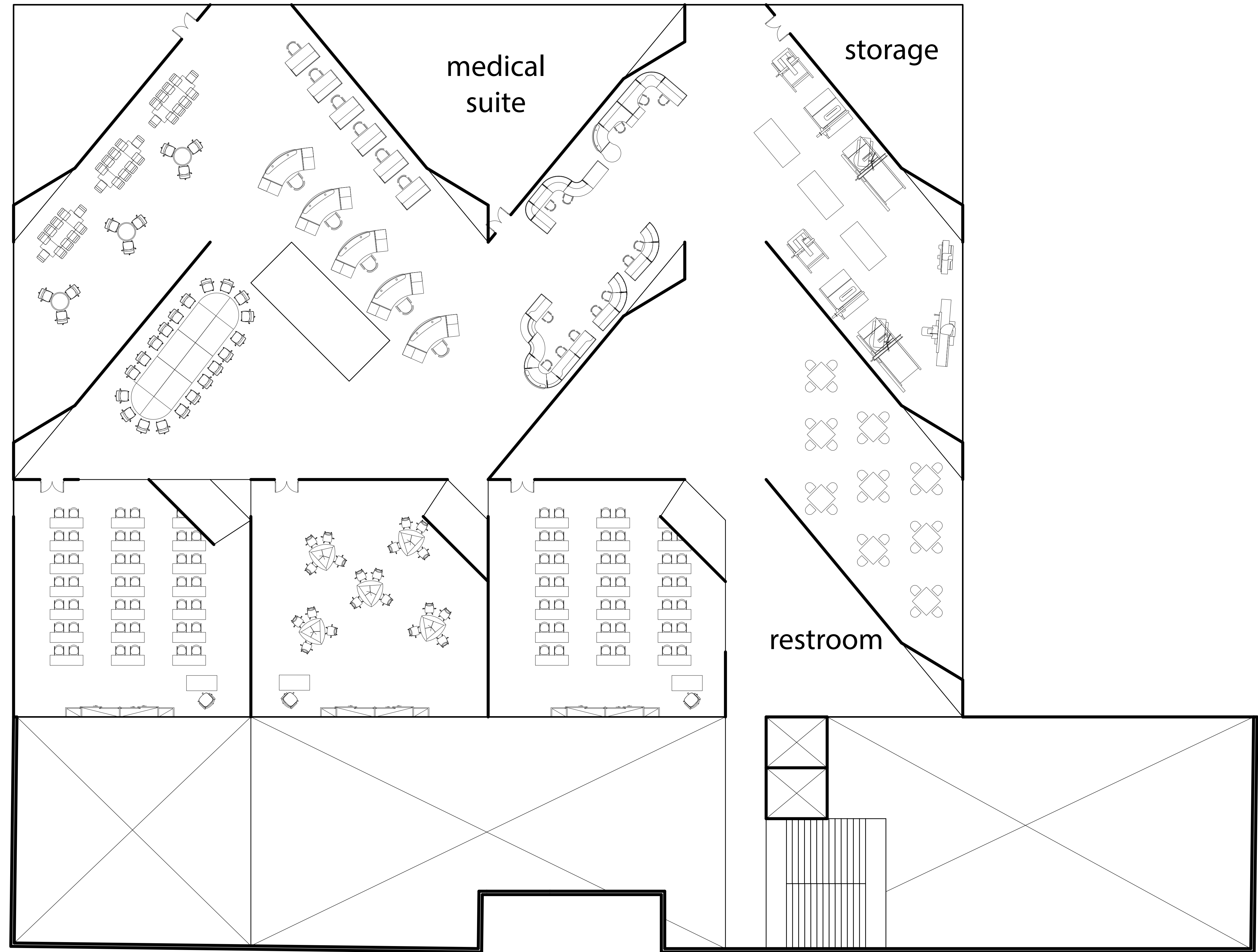

4th Floor Plan



# Construction

