



Intertwined Encounters

Re-imagining the Implied Periphery

Dhruva Lakshminarayanan
MSAAD
2022

Rasam rice
& potatoes
200 cal

PETS

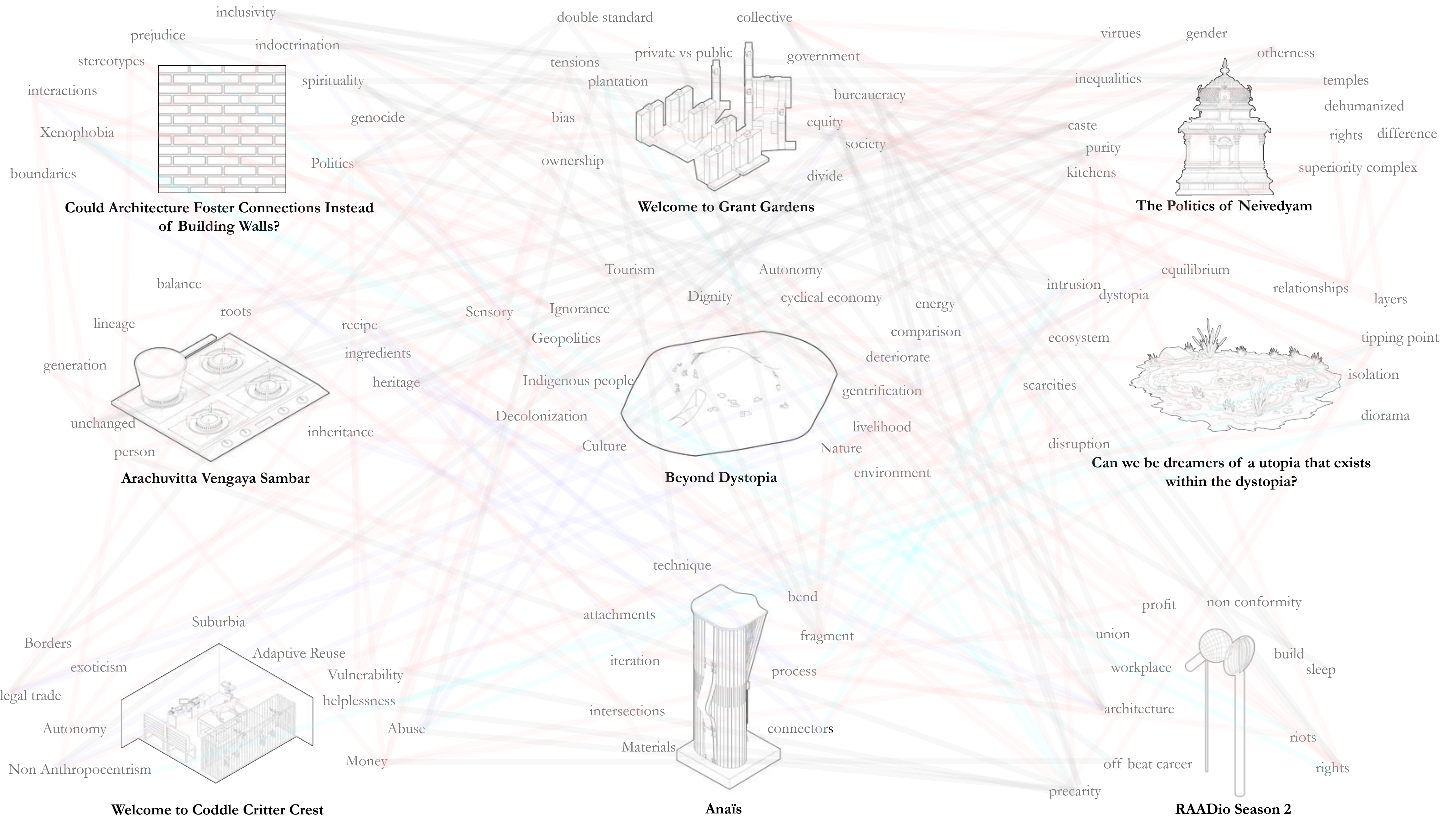

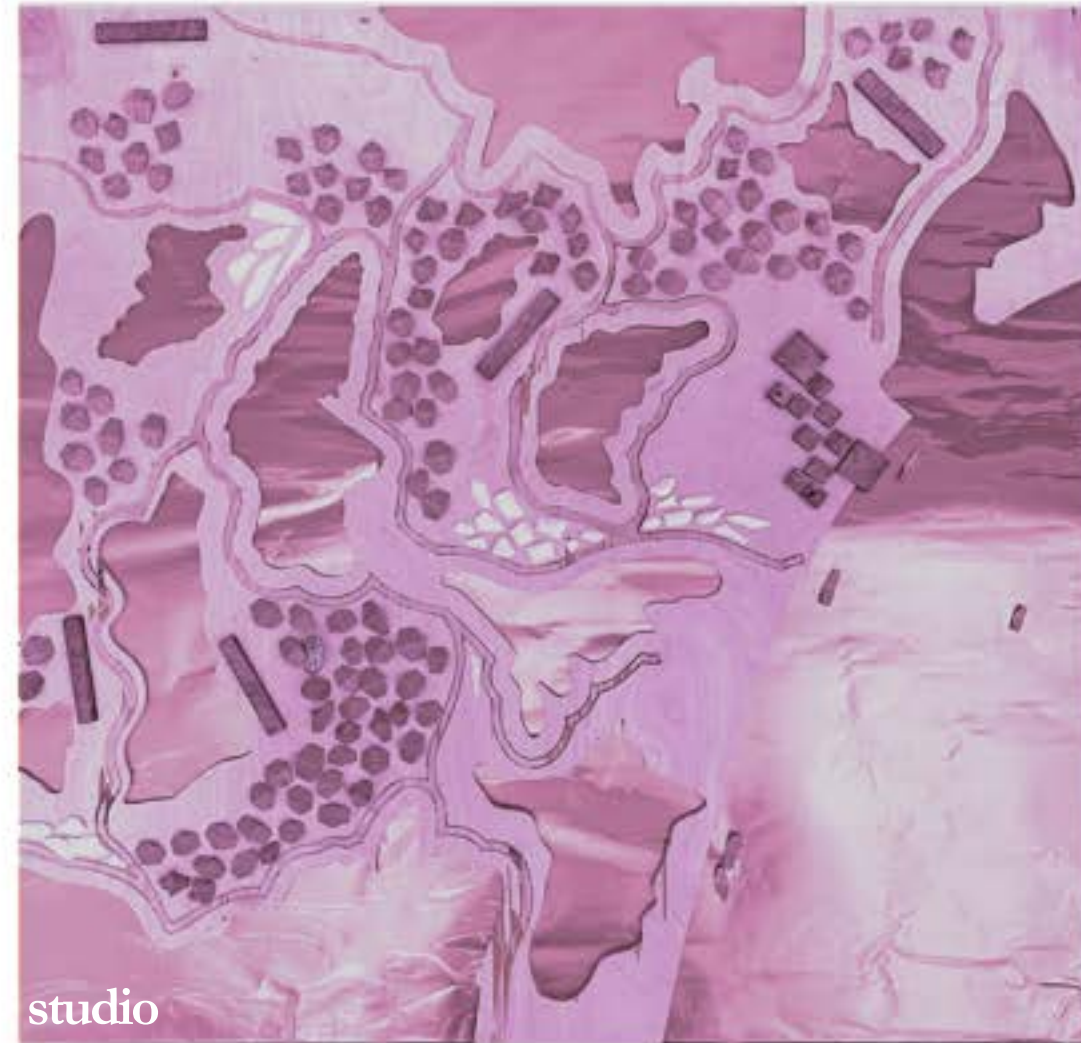

studio



transscalarities

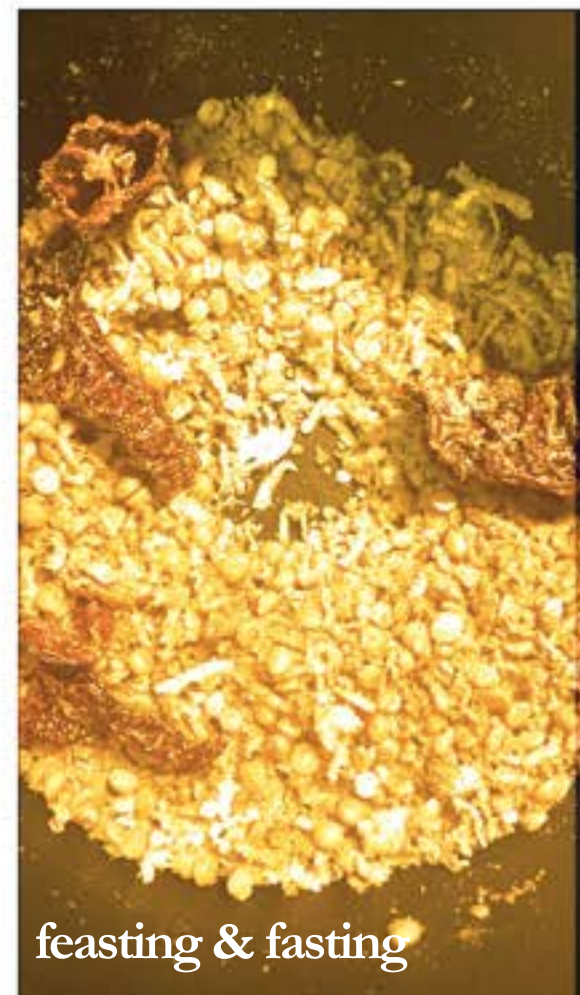

feasting & fasting



1:1 detailing



extracurriculars

Table of Contents

Chapter 01	Could Architecture Foster Connections Instead of Building Walls? ●	06
	Summer 2021 Andres Jaque & Malcolm Rio	
Chapter 02	Welcome to Grant Gardens ●	16
	Fall 2021 Mabel Wilson, Jordan Carver and Emily Ruopp	
Chapter 03	The Politics of <i>Neivedyam</i> ●	34
	Fall 2021 Ateya Khorakiwala	
Chapter 04	<i>Arachuvitta Vengaya Sambar</i> ●	44
	Fall 2021 Ateya Khorakiwala	
Chapter 05	Beyond Dystopia: Finding new Avenues for Redemption at the Salton Sea ●	52
	Spring 2022 Gary Bates & Elie Zeinoun	
Chapter 06	Can we be Dreamers of a Utopia that exists within the Dystopia? ●	70
	Summer 2021 Andres Jaque & Malcolm Rio	
Chapter 07	Welcome to Coddle Critter Crest ●	80
	Summer 2021 Ersela Kripa and Stephen Mueller	
Chapter 08	Anaïs ●	98
	Fall 2021 Zachary Mulitauaopele	
Chapter 09	Dissecting Conformity in Practice- RAADio Season 2 ●	104
	2021-2022	
Epilogue		108

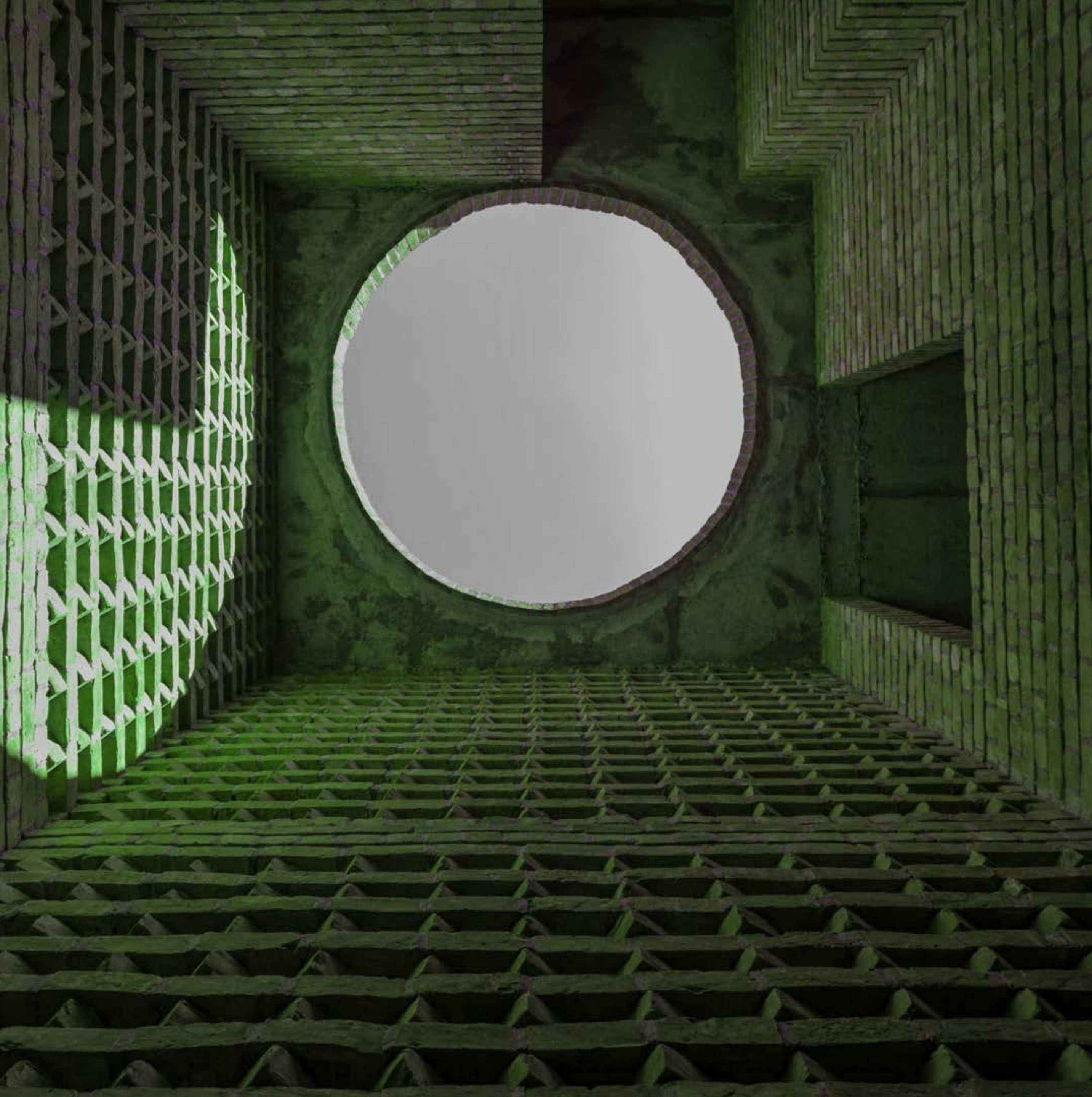

01

Summer 2021
Transscalarities | Assignment II

**In a Progressively Xenophobic World,
Could Architecture Foster More
Transparent Connections Instead of
Building Walls?**

Instructed by Andres Jaque and Malcolm Rio

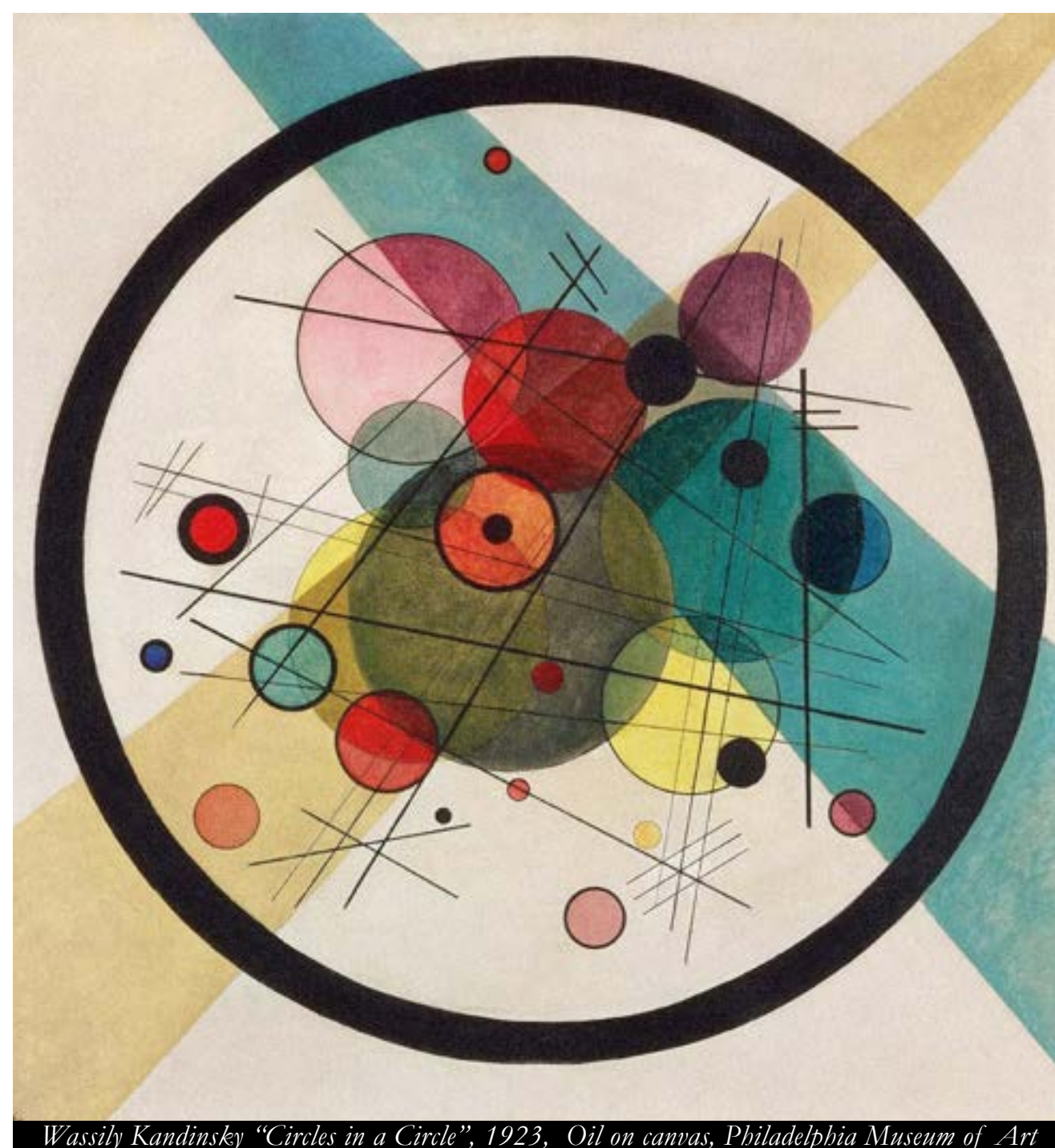

Wassily Kandinsky "Circles in a Circle", 1923, Oil on canvas, Philadelphia Museum of Art

Picture this: It is recess on your first day at kindergarten. As you sit nibbling a sandwich in a quiet corner, you see hundreds of kids playing all around you, but for some reason, you cannot muster the courage to go join them. The onslaught of unfamiliar faces has given rise to a melting pot of emotions within you, accroaching your physical and mental being, almost inducing a sense of nausea. Just when you think you are about to break down into tears, you are approached by two kids that look and speak a little differently from you. With the brightest eyes and the most effervescent smiles, they ask if they can sit next to you, and you nervously agree. As you interact, however, you excitedly realise how much you have in common. And just like that, all your inhibitions vanish in a microsecond.

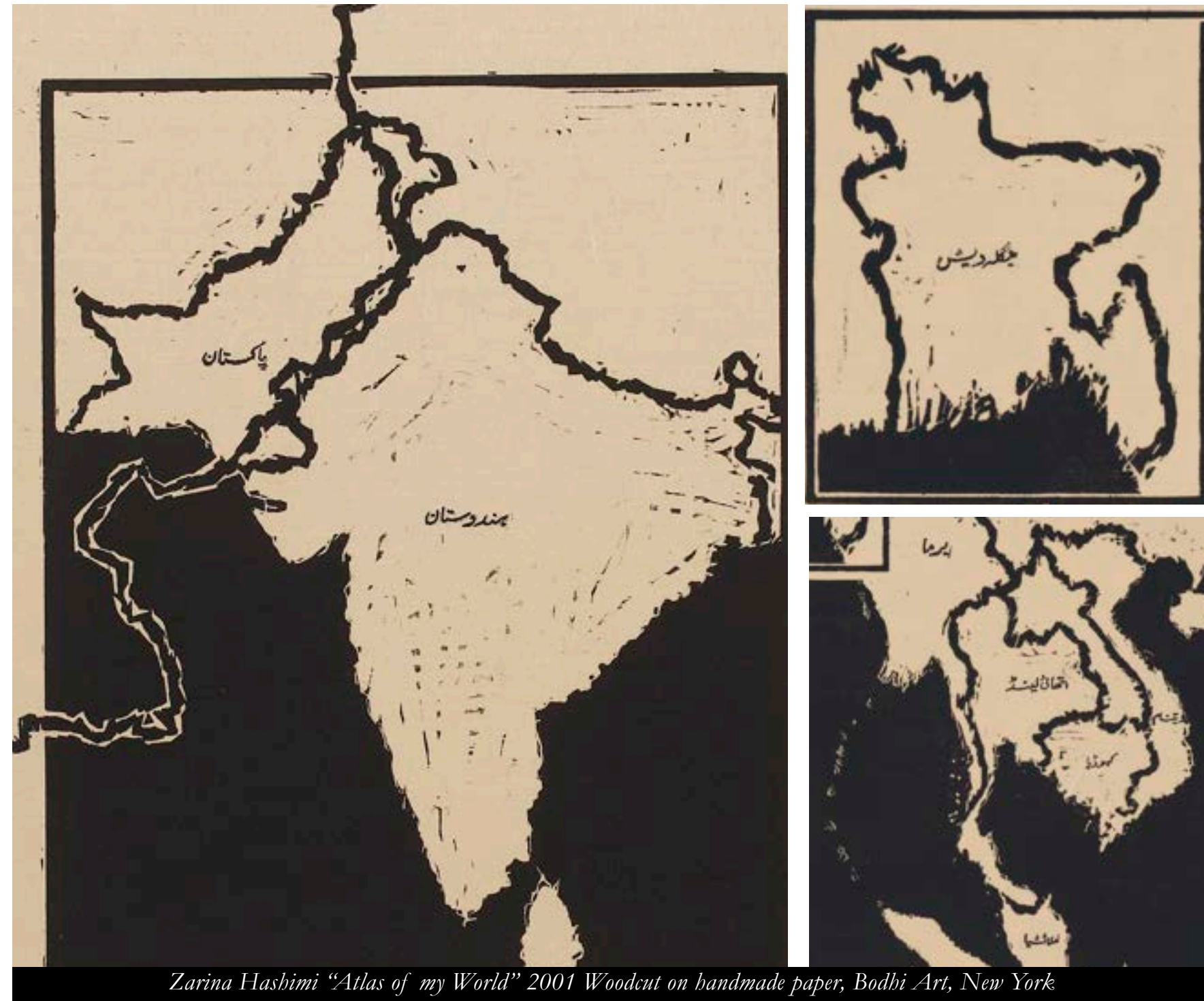

Zarina Hashimi "Atlas of my World" 2001 Woodcut on handmade paper, Bodhi Art, New York

Throughout history, the Indian subcontinent has always been exoticized as this magical land where people of varied cultures live together in absolute harmony. Albeit this oft-heard, compelling rhetoric, the subcontinent has fallen victim, both to regional and colonial, divisive forces time and again, resulting in mass massacres, riots, bombings and even sundered countries. Bangladesh is one such country within this milieu with a dark and chequered past, materialized into its current form after being ruthlessly severed not once, but twice. Sectarian tensions remain rife to this day, with governing bodies sparing no expense at playing partisan politics, manipulating commoners and broadening existing barriers for favors of office. Within this larger context of conflict, could architecture play a greater role in transgressing predefined boundaries, attempting to bring people together?



Shahidul Alam: 'Selfie 3961 3bw', Photograph, 2017, Drik/ Majority World



Shahidul Alam: 'Cricket 3414', Photograph, 2017, Drik/ Majority World

In the increasingly dense and diverse neighbourhood of Faridabad, Dhaka, large congregations of people and rickshaws whir past a humble brick structure nestled within its surrounding landscape of skyscrapers. This is the Baitur Rouf Mosque by Marina Tabassum, which stands as a tangible testament to inclusion within the urban setup, making it as much a community space as it is a space of prayer. This was evidenced quite recently, as the outer colonnade of the mosque was aptly used to house an exhibition by artist Shahidul Alam titled 'Embracing the Other', where visitors were pleasantly surprised by the embracing nature of the mosque. They were welcomed by children playing energetically, some taking a moment of respite in the drastic shadows, people of all faiths perusing the exhibit, all while worshippers prayed at the inner sanctum in silence. A confluence of innate spirituality within the "surrounding chaos."



Screenshot of google search results of the word 'Muslim'

While our myriad differences seem non-existent as innocent kids, they are progressively magnified as we age. When we run a google search for the word 'Muslim', we are quickly bombarded with a million images and news articles of ISIS related violence, "oppressed" women "forced" to wear hijabs, men engaged in polygamy, or hyperbolic statistics of usurped land justifying westphalian anti immigration movements. While this may seem like a legitimate portrayal of Islam to the uninitiated, these results are unsettling, as they colour attitudes and behaviour a certain way. And this is true for any culture that is a minority: we as a society have been doctored, through hearsay, pop culture and social media, to believe in these prejudices and stereotypes, not being allowed to think and interact amongst ourselves and form our own conclusions. Buildings like the aforementioned mosque serve as a reminder that we all connect on a deeper level, having the innate ability to transcend, and hopefully annihilate, the human-made barriers that exist between us.

PROPERTY

Mean / prə-ˈpɜː-ti / \ ˈprɒp-ə-ti /
[Possession] [Ownership]

Something or someone under the ownership and at the disposal of a person or a group of persons, often through legal title. Used primarily for goods and land, the word extended to slaves as commodities in plantation history, where they were not given the right to be in possession of their own selves. Moreover, natural landscapes were claimed as properties for plantation economies.



INDIGENOUS

Adjective / ɪn-ɪ-dʒ-ə-ni-əs / \ ɪn-ˈɪdʒ-ə-ni-əs /
[Aboriginal]

People who are the original inhabitants of a geographic region. Indigenous populations face strong racial discrimination as their rights and properties of have been expropriated by colonial settlers.

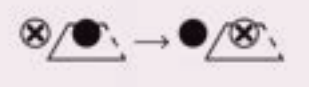

COLONIALISM

Noun / kə-lɒ-ni-əl-iz-əm / \ kə-lɒn-ɪ-ˈz-ɪ-əm /
[Settler Colonialism] [Dominationism] [Imperialism]

A practice in which one group of people dominates and subjugates another, requiring assimilation, inflicting displacement and forcing extraction. Settler colonialism of the Americas stripped indigenous peoples of their lands and exploited slaves through a capitalistic model of production.



amazon echo



POWER

Noun / paʊ-ə / \ ˈpaʊ-ə /
[Ability] [Potential] [Force]

Noun / ɒp-ˈpɜː-s-ə-tiʊn / \ ɒ-ˈpɜː-tʃən /
[Rejection] [Demolition]

Noun / ɪm-ˈpɜː-s-ə-tiʊn / \ ɪm-ˈpɜː-tʃər /
[Domination] [Dependence]

Power: The institutionalization of control and influence over people and things that creates a hierarchy; techniques of influence manifest through surveillance and punishment. Slavery perpetuated a regime of racial hierarchy, where 'omnipotent' slaveowners and institutions constrained slaves' movement and autonomy.

Oppression: The use of power to maintain a hierarchy and discriminate against entities presumed inferior.

Downpression: Understood as an antonym to "up-pression", a sonorous play subverting the power of the word and transforming it into an agent for uplifting. This term is derived from the Rastafarian dialect, a religious and political movement originated in Jamaica in the 1930s.



PLANTATION LOGIC

Noun / p-lan-tə-tʃən lɒ-ˈdʒ-ɪ-ki / \ p-lan-ˈtʃ(ɪ)n lɑː-ˈdʒ-ɪ-ki /
[Racial Hierarchy] [White Supremacy]

An assumed mindset that establishes hierarchical social relations between dominant and marginalized communities. The plantation logic persists today as a structure related to service, city organization, and the value of people in society. It continues to have consequences for marginalized communities, as the logics of possession, out-of-placeness and assumed authority still enforce a hierarchy of social order.



APPROPRIATE & EXPROPRIATE

Verb / ə-ˈprɒ-p-ri-ət / \ ɪ-ˈprɒ-p-ri-ət /
[Expropriation] [Extraction]

Verb / ɪk-s-ˈprɒ-p-ri-ət / \ ɪk-ˈs-ɒ-p-ri-ˈeɪ-ʃən /
[Expropriation] [Expropriation]

1. **Appropriation:** The utilization of something without authority or right granted by the original users. Indigenous land was commodified and monetized by colonial settlers to be turned into plantations. More definitions, etc. etc. if required. Make headings bold.

2. **Expropriation:** The act of dispossessing someone of property or assets by the state or a figure of authority for public use or benefit. Eminent Domain was one of the earliest forms within the United States and continues to displace communities even today.

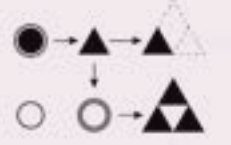

(DIS)POSSESSION

Noun / ˈdɪs-ˌpɒ-s-ə-tʃən / \ ˈdɪs-ˌpɒ-s-ə-tʃən /
[Dispossession] [Belonging]

The structure in which entities in a relationship are in a state of owning or being owned. Dispossession is the act of depriving someone, or a group of people, of land, property and other possessions, including the self. Enslaved populations in plantations were physically and emotionally claimed and controlled by slave owners and their successors continue to exist in a state of deprivation.

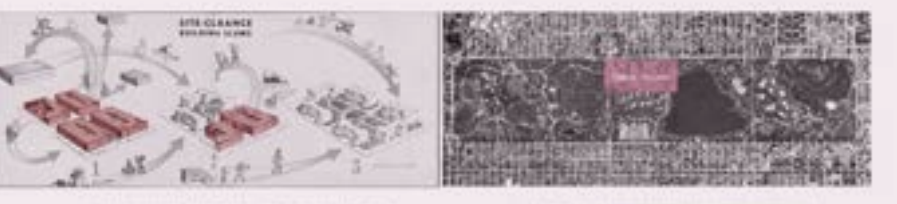

POLICING

Noun / ˈpɒ-l-ɪ-s-ɪŋ / \ ˈpɒ-l-ɪ-s-ɪŋ /
[Social Control] [Law Enforcement] [Surveillance]

A system that protects and maintains a conceived social order, via tactics of violence and surveillance, that relies on racial hierarchies, class differences, gender inequalities, and other inequities. Initially created with the employment of special forces in order to maintain systems of chattel slavery, this system was used to protect interests of the wealthy white elite by enforcing their claims to private property, including humans.

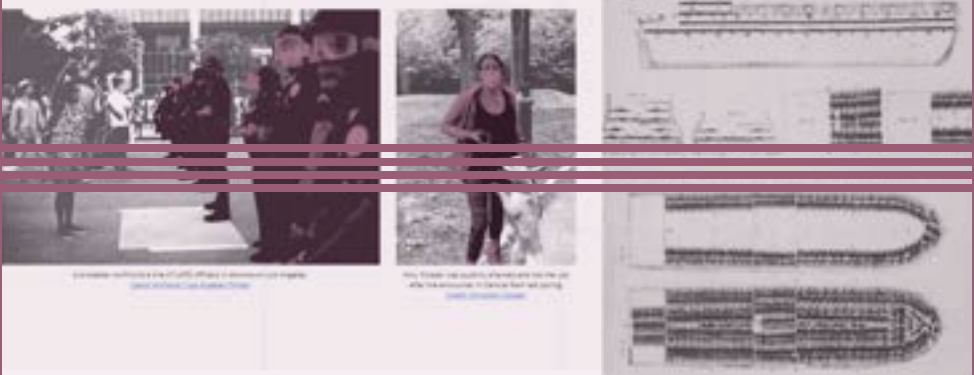
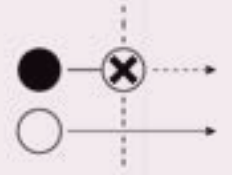

ENCLOSURE

Noun / ɪn-ˈk-ləʊ-s-ər / \ ɪn-ˈk-ləʊ-s-ər /
[Boundaries] [Property Line]

An area that is sealed off and claimed with a physical or representational barrier that is artificial or natural. The plantation enclosure keeps objects or people within or outside of the boundaries, creating a state of being included or excluded through means of materials, policing and architecture.



02

Fall 2021
Studio II

Welcome to Grant Gardens

In Collaboration with Sanobar Khan
Instructed by Mabel Wilson, Jordan Carver and Emily Ruopp

THINGIFICATION

Noun / ˈθ-ɪŋ-ɪ-f-ɪ-ˈkeɪ-tʃən / \ ˈθ-ɪŋ-ɪ-f-ɪ-ˈkeɪ-tʃən /
[Objectification] [Deification]

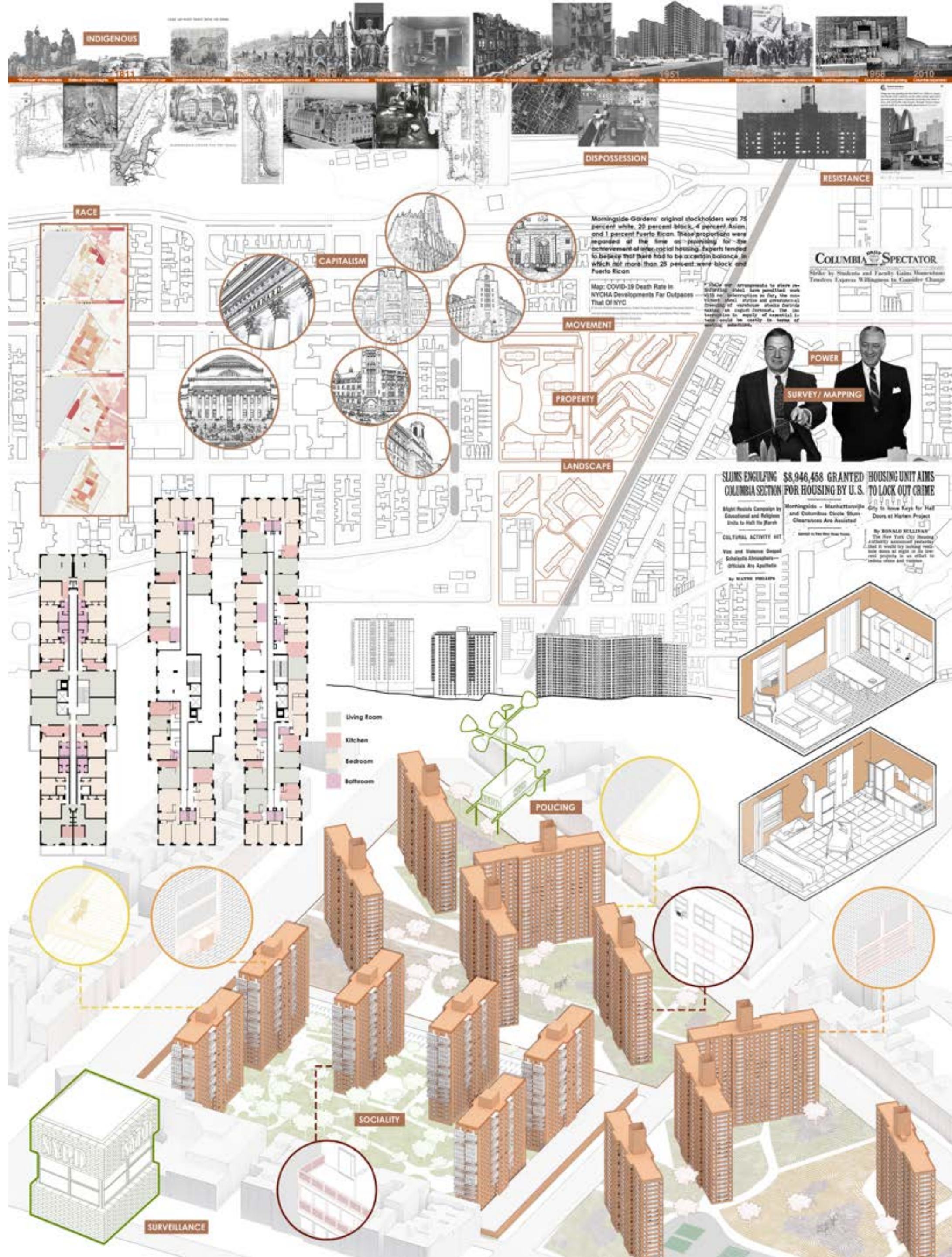

This semester was based on the logics that were applied on plantations and how they are practiced quite rampantly to this day on particular sites. The first part of the semester was used to collectively develop a plantation lexicon: a network of fundamental terms and definitions that were required to be understood and unpacked, forming the basis of the studio. We were then required to choose a site and analyze the extant plantation logics in detail with regards to the lexicon. Two adjacently placed projects: Morningside Gardens cooperative housing and General Grant NYCHA housing were analyzed within this framework, revealing major inequities and double agents. Following the analysis of plantation present on the site, we ask how the two systems at Morningside Gardens and Grant Houses can together reflect collective ownership, such that one becomes less public and the other less private, and what that means for a post plantation future. The project attempts to answer these questions by understanding the similarities and differences between the two projects and inferring the opportunities for intervention.

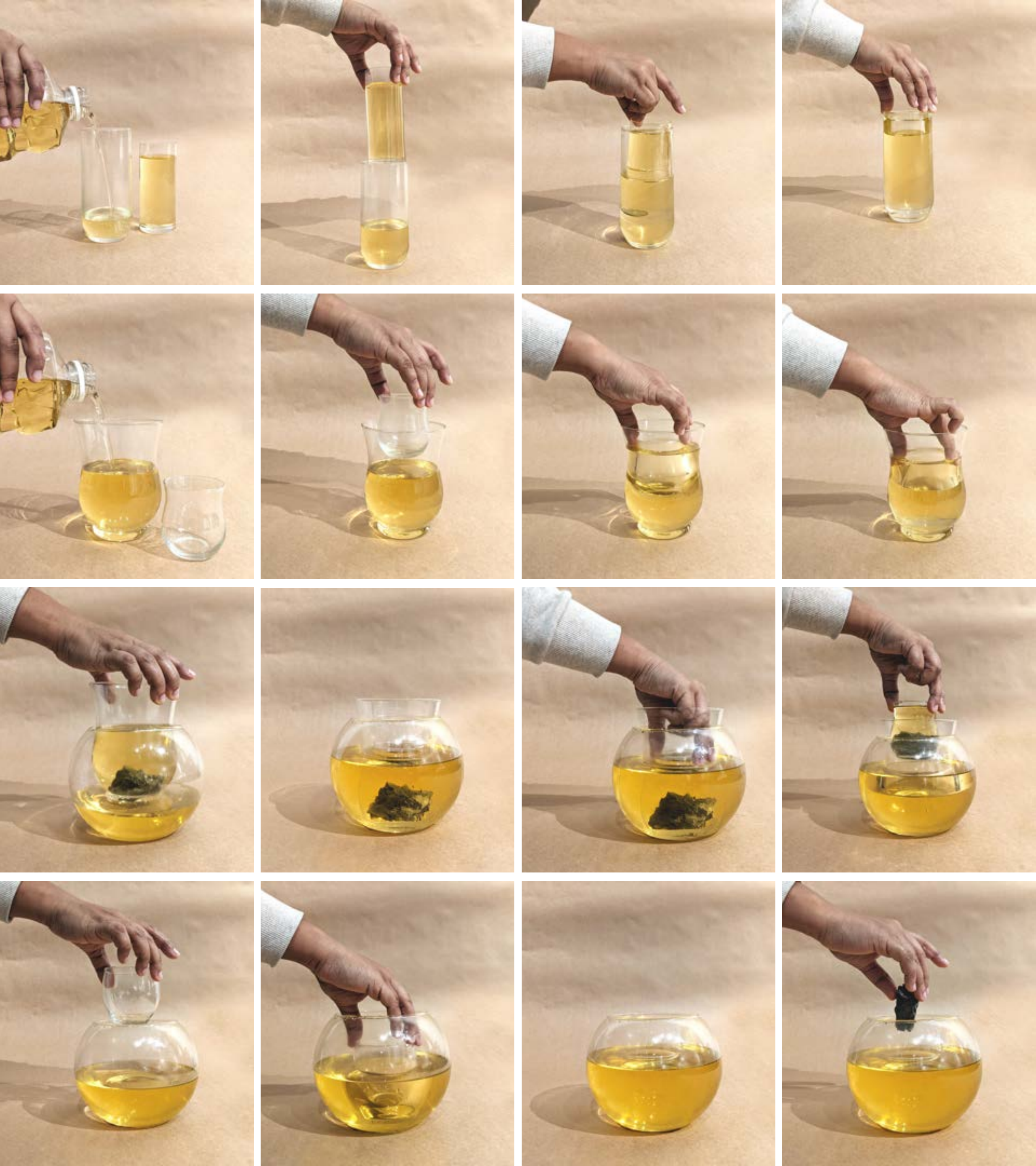

Our first observation on site was that the double agents of decoy and doubling start becoming apparent at the ground level of the projects. We took this as the starting point of our design, asking how these systems of control on the ground level could be subverted and how the two communities could be brought together to generate collective value. We started analyzing and visualizing these experimentally using oil, glass and water to create very specific optical illusions, making us realize the care and subtlety with which such differences had been purposefully orchestrated in the first place, and how the indoctrination would take years to erase. We also realized that subverting these stereotypes could generate collective value. We approached this first by understanding what exists, and then by designing a new system through networks that support each other, like community kitchens, farms, retail spaces and eateries that weave into public as well as domestic spaces, facilitated through architectural and placemaking devices. Ultimately, we envision this system being adopted in public housing projects across New York City, enabling communities to be better integrated within their larger neighborhoods.

NYCHA Vs Co-op

Not as different as made out to be

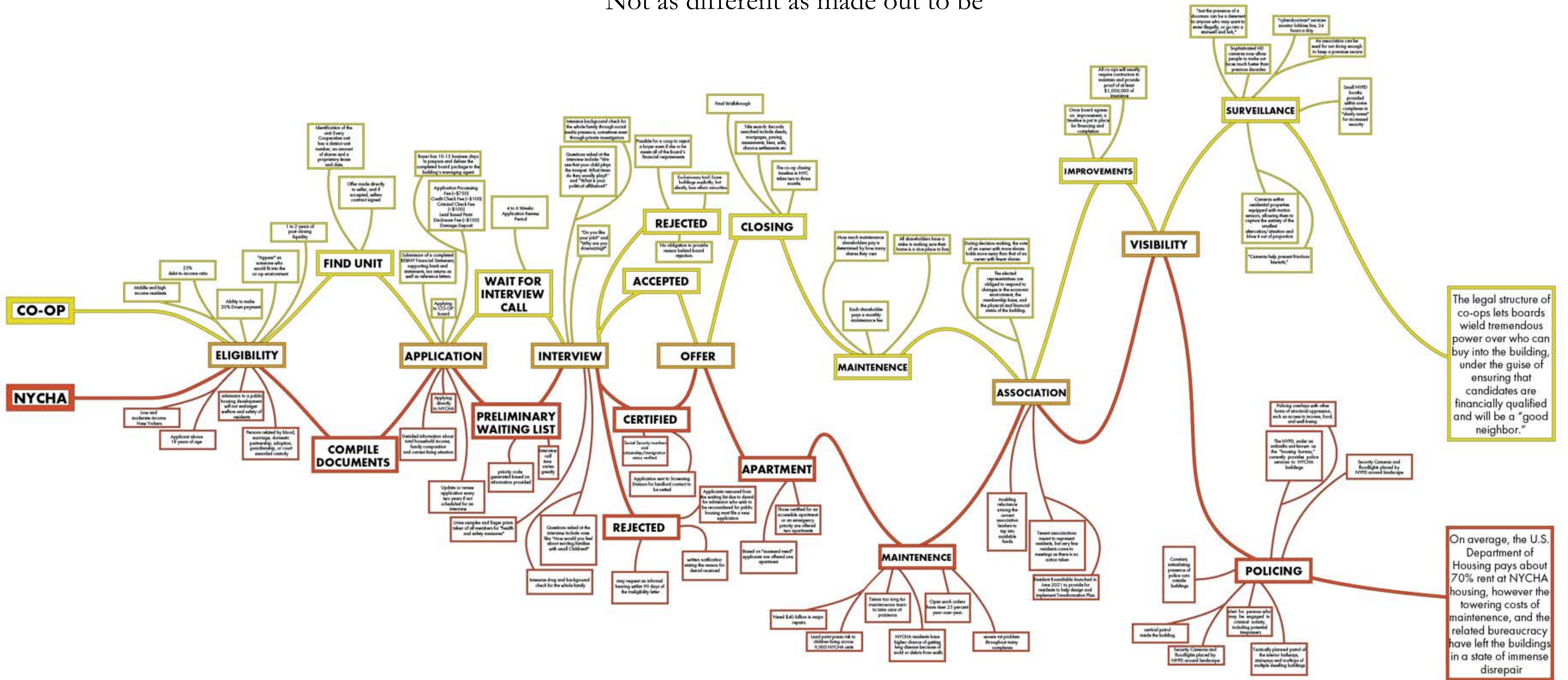

The legal structure of co-ops lets boards wield tremendous power over who can buy into the building, under the guise of ensuring that candidates are financially qualified and will be a "good neighbor."

On average, the U.S. Department of Housing pays about 70% rent at NYCHA housing, however the towering costs of maintenance, and the related bureaucracy have left the buildings in a state of immense disrepair.

Welcome to Grant Gardens The Intervention

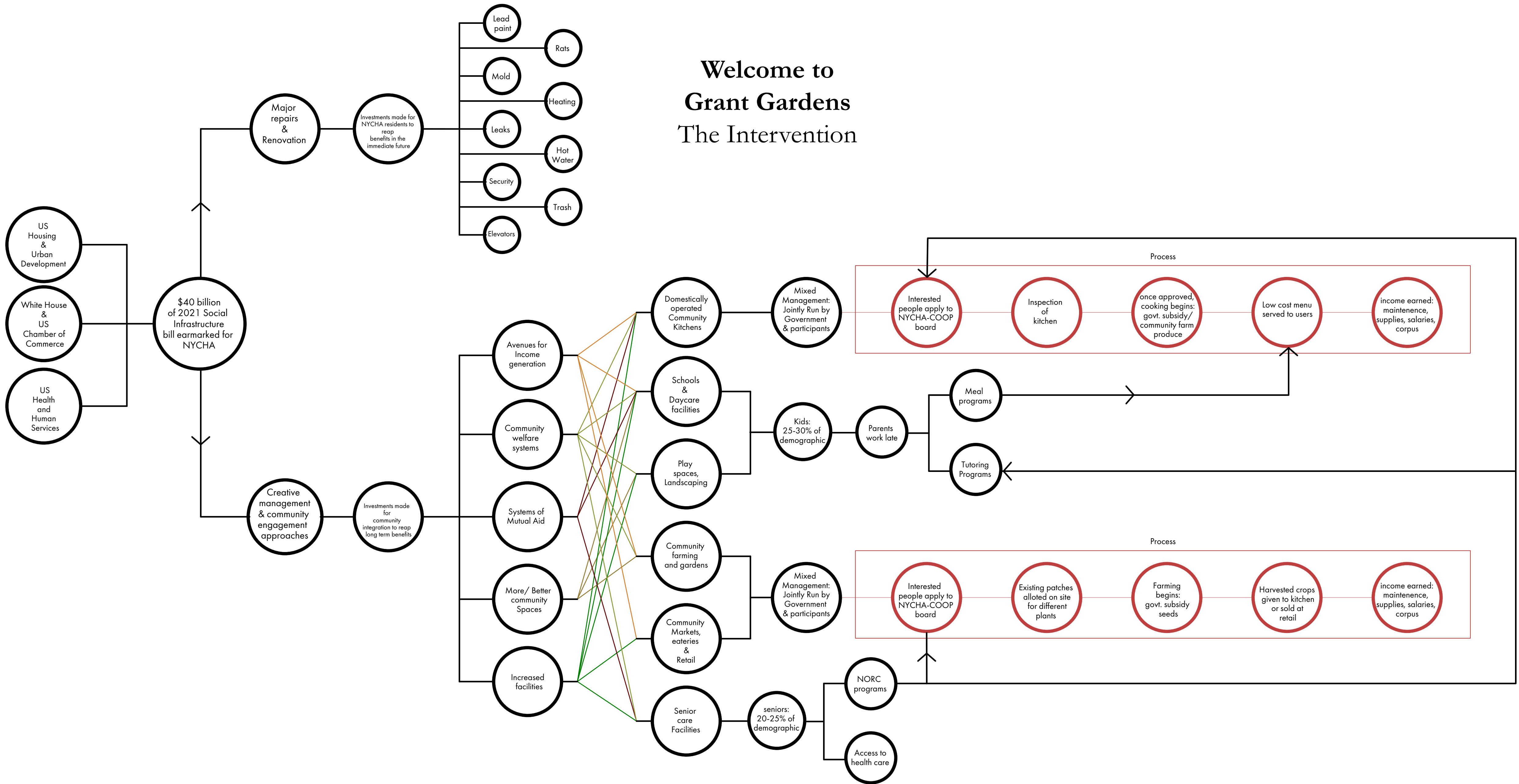

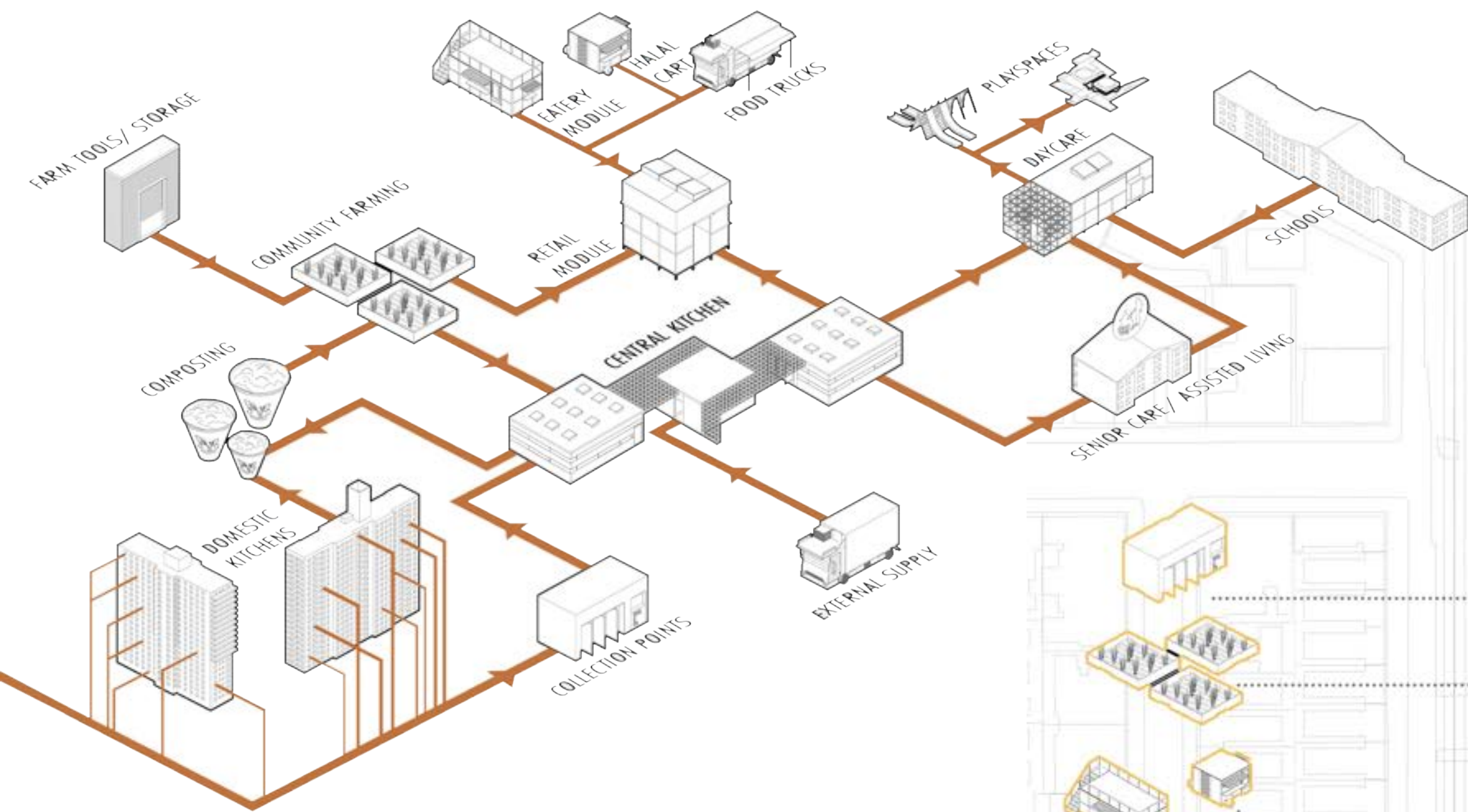

The Grant Gardens Network

An interconnected network of community farms, daycare facilities, community kitchens, markets, eateries etc that engages the entire community and enables attitudes of collective ownership to emerge and flourish



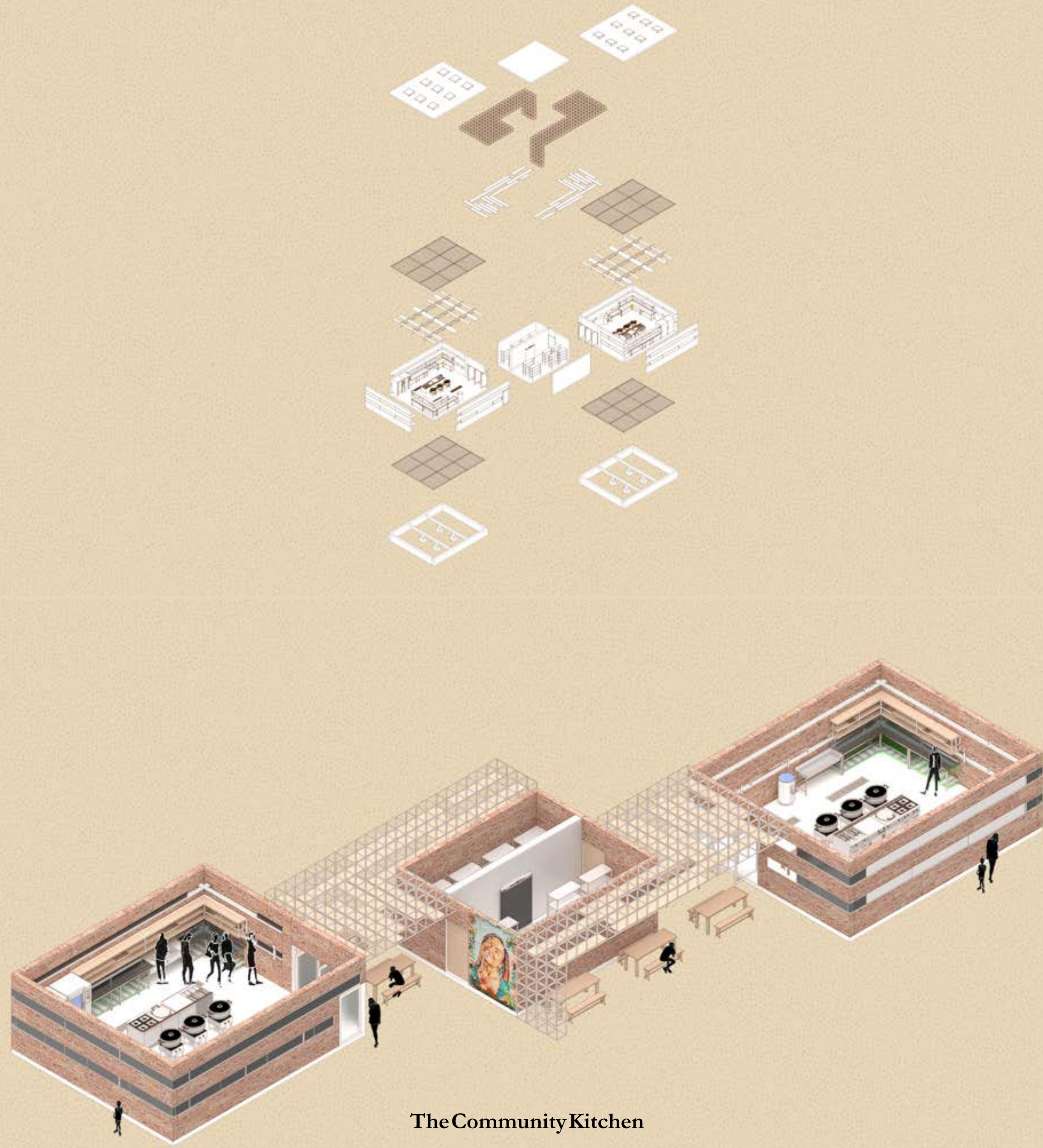

The Community Kitchen

This is how the networks function in relation to each other. Going off of the governance diagram, we are proposing a network of community kitchens, consisting of a central kitchen, domestic kitchens doubling as community kitchens, and collection points in each building lobby for the food prepared in these domestic kitchens. The idea is that because of government subsidies, the menu can be sold at a very low cost, allowing for a minimum wage to be paid to those preparing food and maintaining the spaces. The food prepared in these kitchens serves not only the community but the children at the daycare facilities and senior care homes in the immediate surrounding. These kitchens are also linked to the non-subsistent community gardening, allowing volunteers to maintain the gardens and the kitchens approved by the board to be able to use the produce. Waste from the kitchens feeds the composting process which is eventually reintroduced to the gardens. The gardening and composting infrastructure is supported by equipment and tool management carried out by the community. We propose the removal of La Salle street between the two sites so that the two can be physically stitched together. Eateries, halal carts and retail modules, possibly also linked to the kitchens and gardens take this space to create an opportunity for the communities to engage. The system attempts to facilitate the formation of a singular community and a sense of collective ownership by engaging with the public as well as the domestic realm.



The Daycare Unit

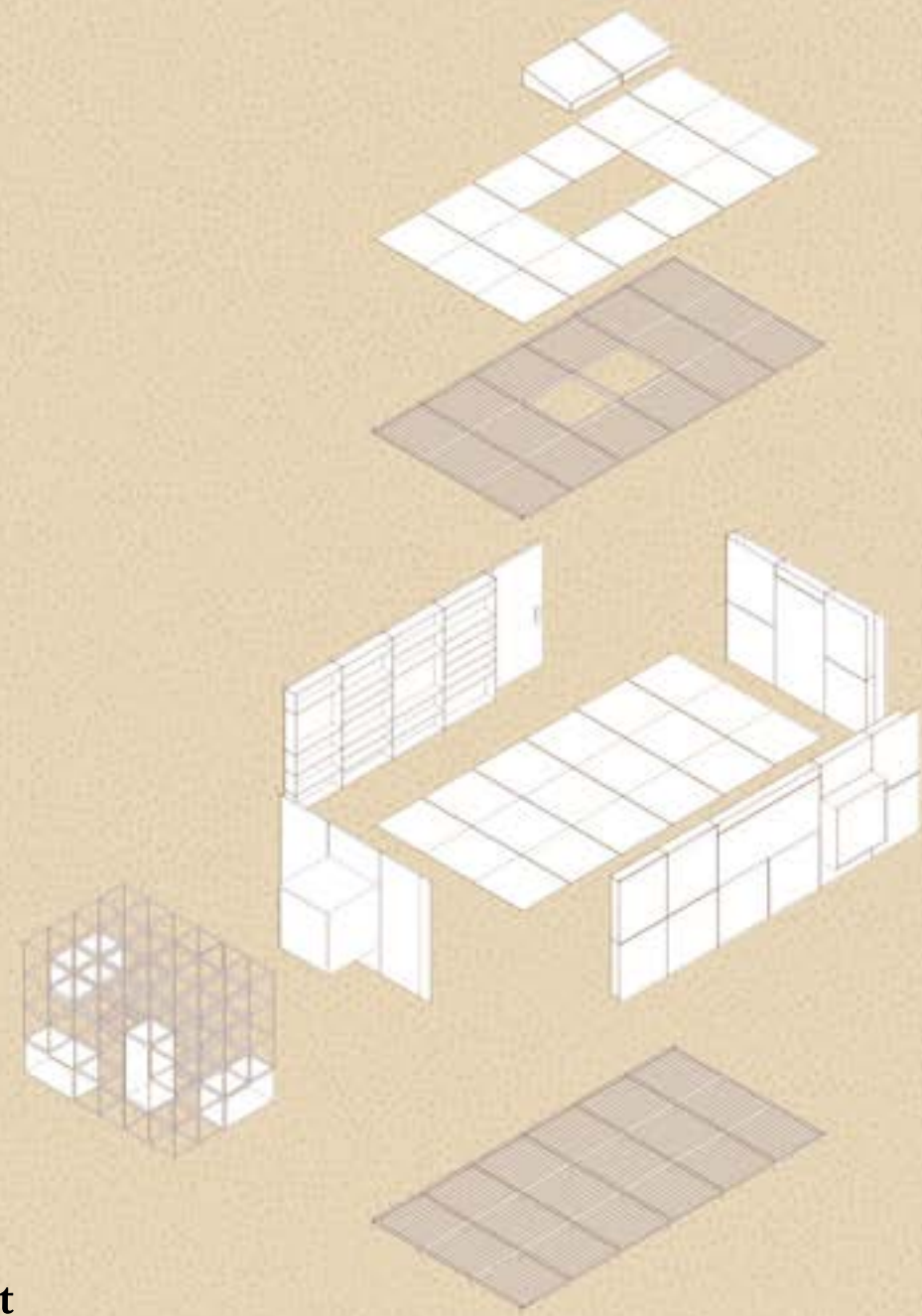

The Halal Cart

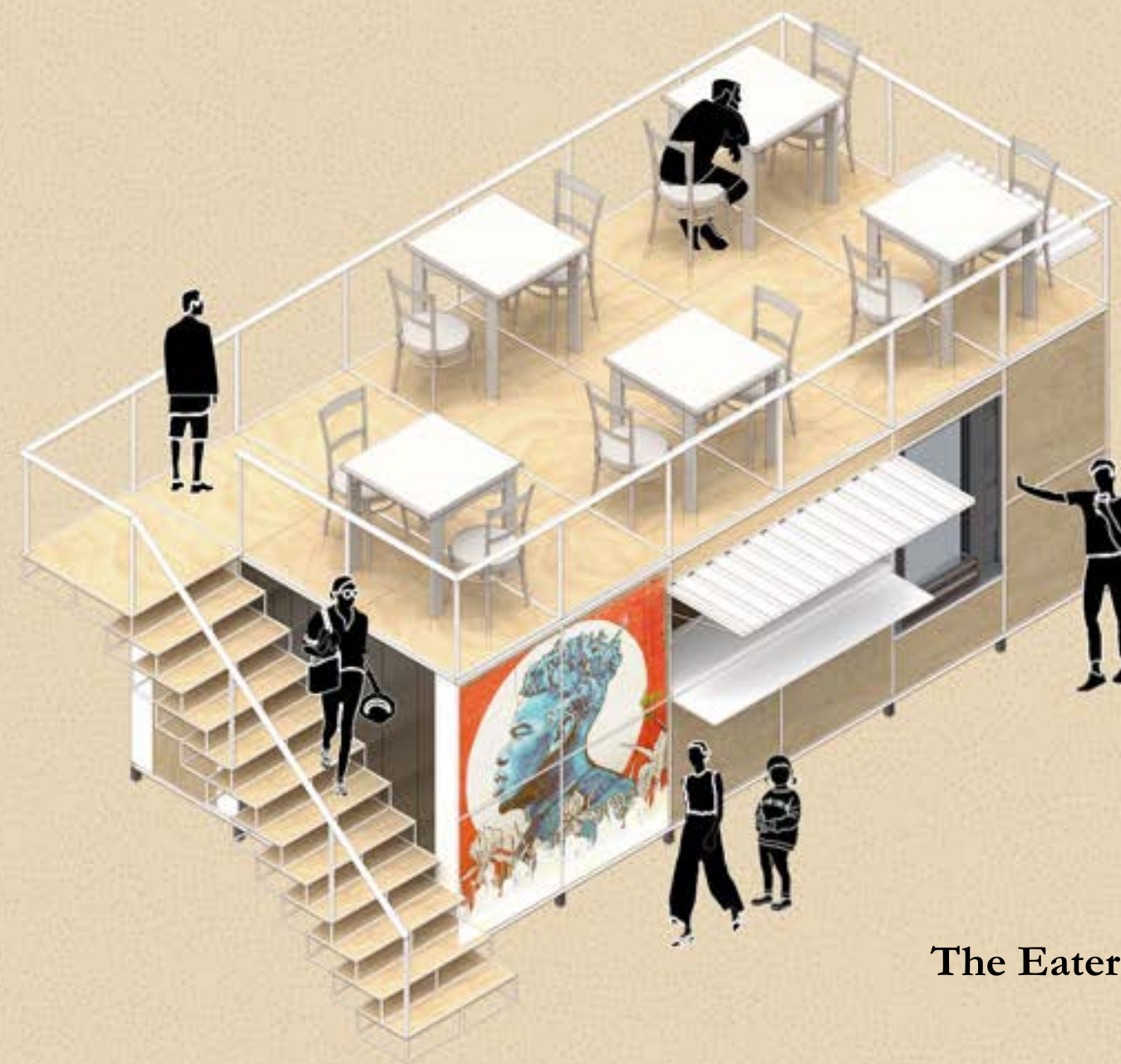
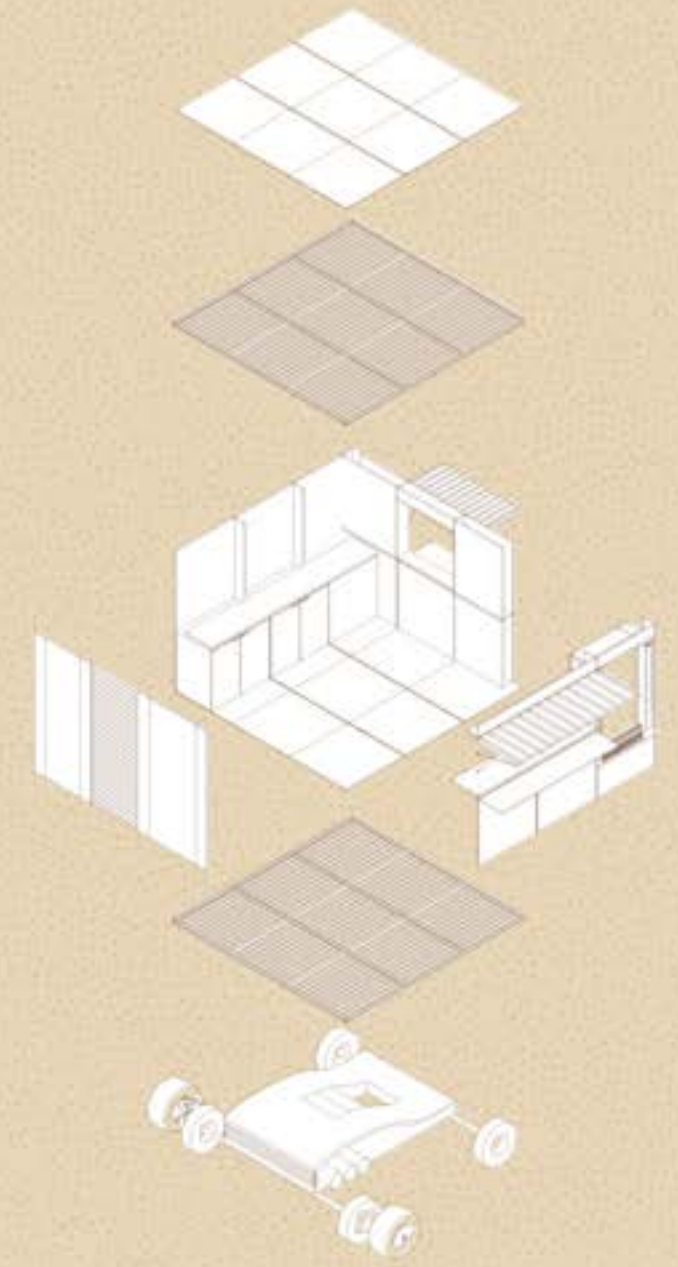

The Eatery Unit

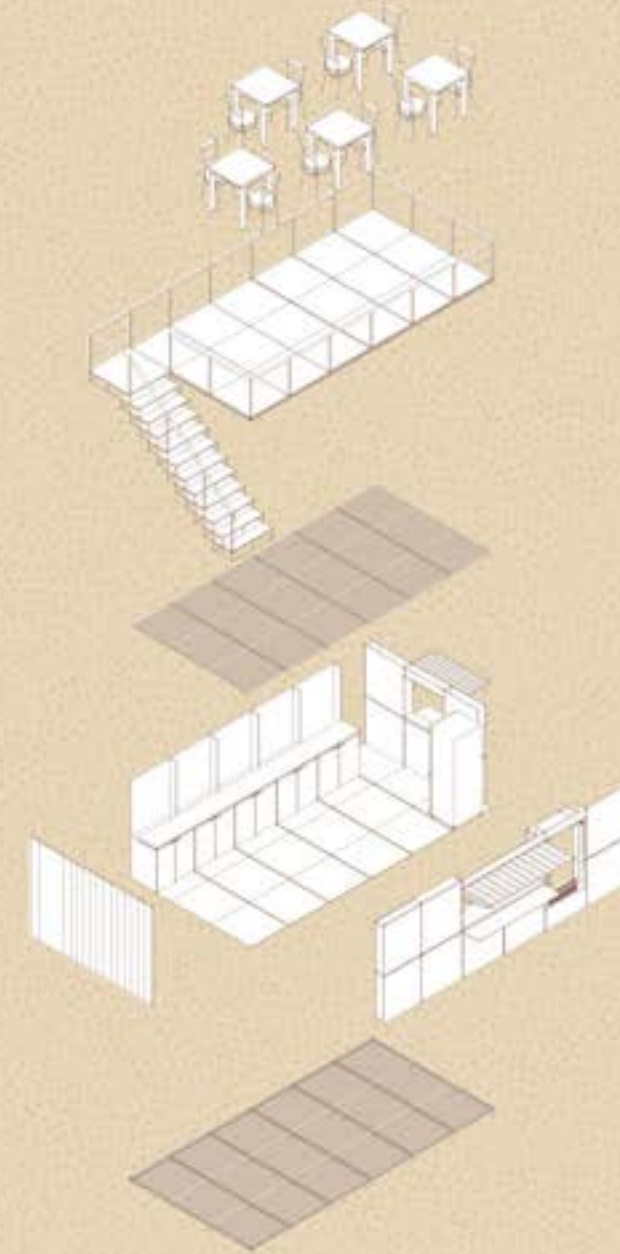

The Retail Unit

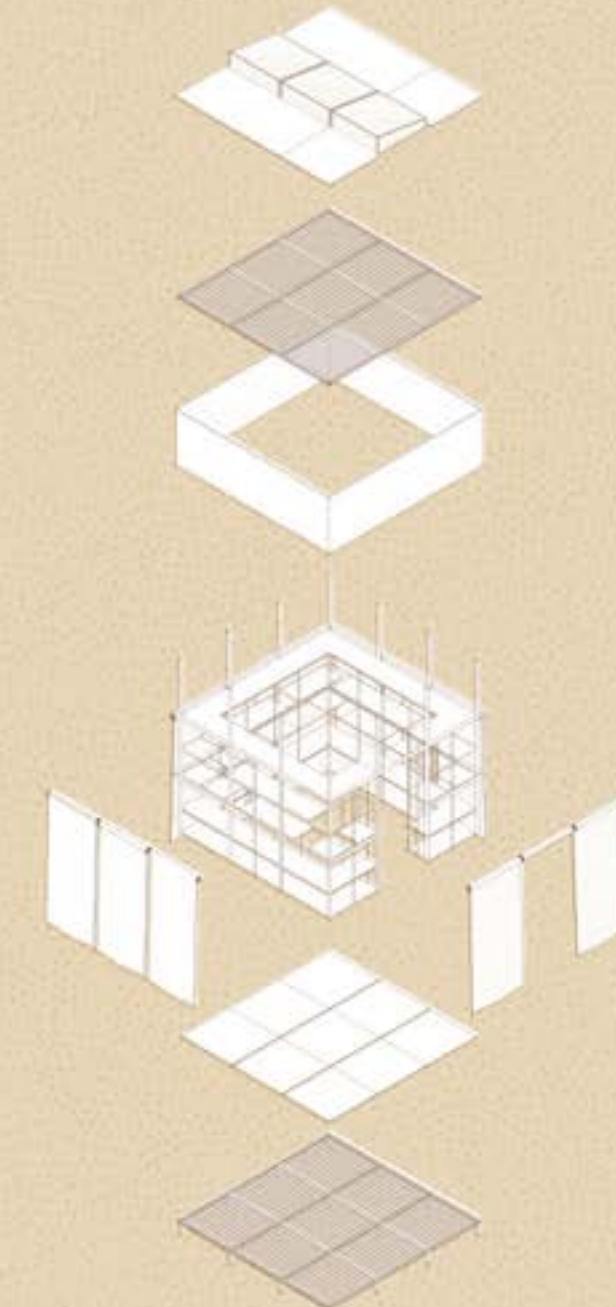



HI I'M ANDREW! NICE TO MEET YOU. CARE TO HEAR A STORY?



GROWING UP THIS WAS THE VIEW FROM MY BEDROOM WINDOW AT THE GRANT HOUSES... I KNOW IT LOOKS LIKE FUN AT A GLANCE, BUT WAS IT REALLY?



YEAH, OUR BATHROOMS COULD HAVE REALLY USED SOME HELP.



IT ALSO GOT PRETTY SCARY WITH ALL THE PO-PO AROUND 24 X 7.



RIGHT ACROSS FROM US, THERE WAS MCKINSEY'S GARDENS... SO CLOSE, YET SO FAR...



ONE MORNING ENROUTE TO SCHOOL, I NOTICED THAT LASALLE STREET THAT DIVIDED US AND 'THE GARDENS', WAS BEING TORN DOWN, UGH, ANOTHER OVERPASS?



THE SAME DAY, I SAW MY FRIENDS' PARENTS WORKING THE DRY AND DEAD 'LANDSCAPING' AROUND OUR APARTMENTS.



IT DIDN'T STOP THERE! A FEW WEEKS LATER, THERE WERE ENGINEERS AND CONTRACTORS AT OUR DOORSTEP TO FINALLY 'SIGN' FIX OUR APARTMENT!



THEN ONE AFTERNOON, I SAW MUM COOKING UP A STORM IN THE KITCHEN. WHEN I ASKED HER WHY, SHE JUST SMILED AND SAID 'SON, EXCITING THINGS ARE HAPPENING!'

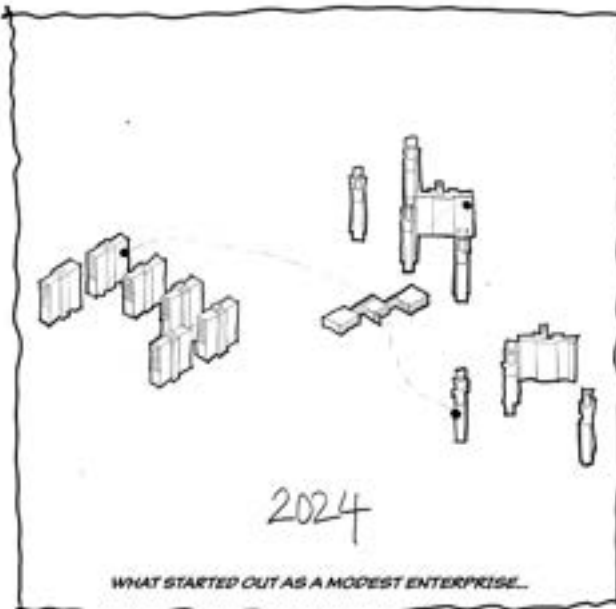

WHAT STARTED OUT AS A MODEST ENTERPRISE...

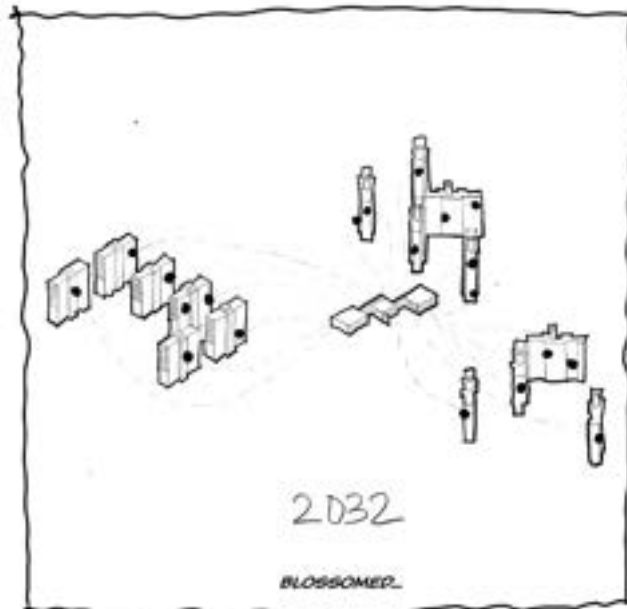

BLOSSOMED...

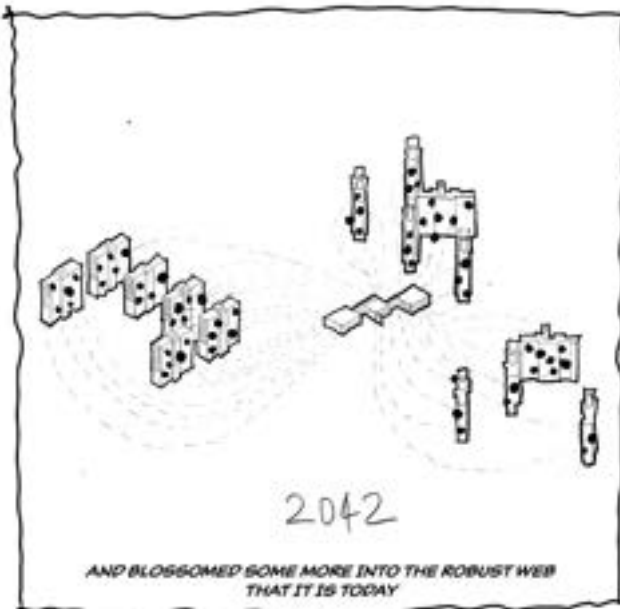

AND BLOSSOMED SOME MORE INTO THE ROBUST WEB THAT IT IS TODAY.



THE SEEDS OUR PARENTS SOWED 50 YEARS AGO...

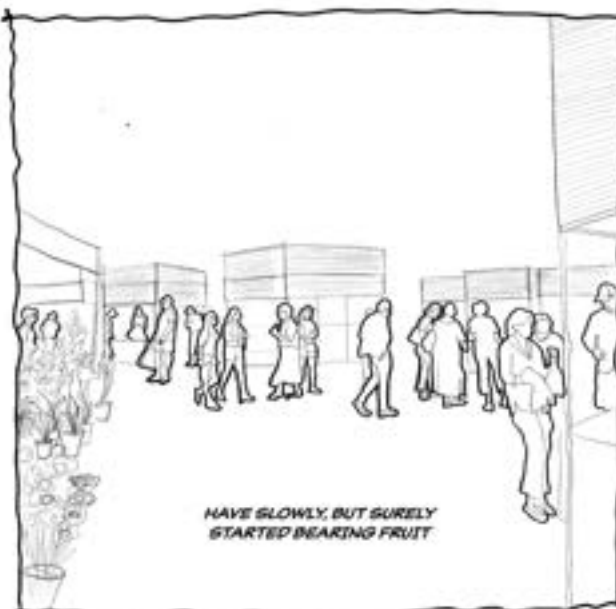

HAVE SLOWLY, BUT SURELY STARTED BEARING FRUIT.



AND THAT'S THE STORY OF HOW WE WERE FORGED INTO A COMMUNITY.



NOW WOULDN'T IT BE AMAZING IF THIS HAPPENED MORE IN NEW YORK CITY?

WHAT WOULD IT TAKE?





03

Fall 2021
Feasting & Fasting | Essay

The Politics of ‘Neivedyam’:
How is Discrimination Based on Caste
and Gender Perpetuated Within the
Confines of the
South Indian Temple Kitchen?

Instructed by Ateya Khorakiwala



Idols of Sri Rama, Sita and Lakshmana riding a swing, Tirupati

Within the centuries old, yet rapidly evolving, realms of Hinduism, while the Gods are believed to reside in the heavens, they are said to periodically take up different human forms to safeguard their devotees from nightmarish hurdles and maintain the world's equilibrium. To facilitate this, temples are built and venerated as the terrestrial residences of these myriad Gods, and the deities themselves are made to go through all the motions of a normal individual: They are woken up, bathed, dressed in finery, entertained, fed and put to bed. Apart from these more celestial functions, temples, since the most rudimentary stages of their conceptual formulation, have always played a pivotal role in weaving the socio-economic fabric of the rural/ urban contexts they are situated within. Especially in the south Indian context, the generous amounts of capital being poured into temples, allowing them to thrive were, in turn, also meant to sustain the dominantly agrarian society come dire circumstances, requiring them to function simultaneously as banks, storage facilities, retail outlets, and much more. Within this multifaceted milieu, the production, consumption and distribution of food has evolved into an integral and inextricable part of daily worship, where in the temple kitchen is positioned centrally with respect to the overall network. However, through the years, patterns of labor and land ownership in agrarian society, the extant (hint: flourishing) caste system and the generational indoctrination of the inferior status of women, created room for unprecedented social stratification and hierarchical divides in the sequestered space of the temple kitchen in the name of purity, kernels of which are kept alive to this day in the guise of tradition.



View of 'Potu' Kitchen at Tirupati Venkateswara temple showing 'Potu Karmikulu' Making Laddus

Andhra Pradesh: Mirasidars and caste-based advantage at the Tirupati Venkateswara Temple

First Initiated in 1715, Tirupati *Laddu*, or sweet gram flower ball, is the offering made to Lord *Venkateswara* at this shrine, having now become almost synonymous with the temple among devotees. The problematic here lies in the recently abolished *Mirasidar* system, where the laddus were to be made in a special kitchen within the temple premises known as *Potu*, only by around 150 men known as *archakas* from the highly specific *Gamekar Brahmin Mirasidar* families, who acquired their position solely based on caste and heredity. In addition, out of every fifty-one laddus made, eleven were given back to the families of these *laddu* makers, apart from their salaries, to sell at self-stipulated prices, thereby allowing them to take undue advantage of buyers and make huge profits.



Larger open kitchen at Udupi Sree Krishna Temple



Made Snana at Udupi Sree Krishna Temple

Karnataka: Chowki kitchens, Pankti Bedha and Made Snana in Udupi Sree Krishna Temple:

The incarnation of the deity ardently venerated at the Udupi Sree Krishna temple is *Anna Brahma*, or the Lord of food. As a result, wholesome meals have been provided here to all pilgrims free of cost for centuries. While an initial reading of this temple and its kitchen paints a well intentioned picture, the hierarchies become apparent at two levels: firstly, between human and the Deity, and secondly between human and human. The food meant for Lord *Anna Brahma* is prepared within a completely cloistered, severely guarded kitchen known as the *Chowki*, where only a select number of priests solely from the *Shivalli brahmin* caste are allowed entry. Simultaneously, all the food for the pilgrims is made in a larger open kitchen with an adjoining dining hall where human-human segregations, start becoming visible with the still prevalent practice of Pankti Bedha; where brahmins are made to sit in a different dining hall than others, and Made Snana; a demeaning practice where people of lower castes roll over the plantain leaves of Brahmin men.



Attukkal Bhagavathy temple Pongala ritual

Kerala: Pongala of Attukkal Bhagavathy temple, truly non-discriminatory?

Featured in the Guinness Book of World Records for being the single largest religious gathering of women worldwide, the *Attukkal Bhagavathy pongala* ritual in *Thiruvananthapuram*, is a rare case where women of all castes, and even religions, are allowed to make a rich concoction of boiled rice and jaggery and offer it to the residing goddess. While this ritual exhibits to a degree that gender and caste discrimination could be eliminated for more quality and unity, even in this case, the ritual only begins when the *Melshanthi* or the main Brahmin priest of the temple lights the fire at the *Thidapally*, or the temple kitchen, and the *Potti* or the subordinate priest comes out of the sanctum sanctorum to sanctify the exterior hearths, making it possible for the 'otherness' to even be legitimized by the temple authorities.



Men making mutton biriyani through the night at the Vadakampatti Muniyandi Temple

Tamil Nadu: Chicken/ mutton Biriyani Neivedyam at Vadakampatti Muniyandi temple:

Home to one of south India's very first restaurant chains, the annual festival of the Vadakampatti Muniyandi temple, replete with with street processions, folk dance performances and colorful lighting displays, is a spectacle to behold. The highlight, however, is the uncommon practice of offering slow-cooked, chicken/ goat biriyani to the resident Lord Karupannaswamy as *neivedyam*, which is then offered as breakfast to people of all ages, castes and religions without any discrimination. Given that the people who pray at this temple have backgrounds in farming or trading, it could be discerned that meat and rice have been central dietary aspects and ergo, must be offered to the Gods to ensure sustained supply. Amidst this context, the problematic lies in the fact that while women are allowed, and in some cases even required, to clean the meat and sort the rice, the cooking is done only by men, a tendency that also probably harks back to the restaurant chain culture of the village, who volunteer to cook the biriyani through the night.



Boards preventing women from entering temple while menstruating



anti caste protest outside temple

Conclusion

Through this research paper, it is evident that the south Indian temple in general, and the kitchen and food making process specifically, is a politically charged zone where disparities of caste and gender continue to play out quite blatantly, without much discretion. This is seen through the structural hierarchies extant within the Mirasidari system of Laddu production at the Tirupati Venkateswara temple, attempts at caste-based segregation and dehumanizing endeavors at inflicting caste superiority at the Udupi Sree Krishna temple, the prevalence of caste based stratification even within the supposedly casteless space of the Atukkal Bhagavathy temple and the notions of patriarchy and purity that become apparent even at the supposedly non-conventional Vadamkatti Muniyandi temple. It becomes clear that similar issues definitely exist in all of these spaces, but at varying degrees of impact. The research conducted for this paper has thrown some light on a few glaring examples of discrimination and stereotype at south Indian temples, however the sheer magnitude of temples and the atrocities and anomalies in each is numerous, and therefore falls beyond the scope and boundaries of this paper. Thus, this deep-rooted analysis of Prasadam and Neivedyam practices in South India reveals that given the central, pivotal role of the temple in bringing the together socio-economic contexts, it plays a major, detrimental role in perpetuating ideas of caste and gender inequalities across generations through religious traditions and ritualistic practices. Even the food one offers as neivedyam to the deity is dictated by one's background and lived experiences, showing a tiny, possibly poignant glimpse of how one visualizes the world and how ideas of caste, gender, equality, liberty and freedom are communicated through that perception.



04

Fall 2021
Feasting & Fasting | Recipe Compilation

Arachuvitta Vengaya Sambar:
The Piece de Resistance of the
Palakkad Iyer Kitchen

Instructed by Ateya Khorakiwala



Since I was a kid, I had always been told that this recipe was unparalleled: “*Namma aatbile Vengaya sambar pannina agrabaaram pooru manakkumnu Cholluva*”; the fragrant aroma of our special *sambar* was supposedly known to permeate through all the houses of the ‘*Agrabaaram*’; The commune. While I dismissed such statements as mere hyperbole, (much to my mothers annoyance mind you), I always thoroughly enjoyed eating it. I had eaten *sambar* at restaurants, at weddings, even at friends’ houses, but while it was faintly similar, nothing could ever hold a candle to what graced my dinner table every other day. There was something extremely unique about the way in which the flavors coalesced, something I was always curious to wrap my head around. So, one evening on facetime, when I candidly announced that I had been given this assignment and that I wanted to make our humble *sambar*, *Amma* was only too happy to disclose her closely held family secret. She had learnt it orally from her mother, *Narayani*, who had, in turn, learnt it word for word from her mother, *Subbulakshmi* and so on. Save for technological interventions for convenience, it is considered *harakiri* in my family to alter the proportions, ingredients and methods of this recipe. As a result, even though kith and kin have spread far and wide today and the concept of home keeps shapeshifting through time, somehow, miraculously, this recipe has allowed the spirit of the *agrabaaram* to shine within all of us. Through the tartness of the tamarind, the sweetness of the shallots, the redolence of the ghee and the bite of the curry leaves, I find myself tethered with something far beyond myself as I follow this recipe, and I hope with all my heart that you, dear reader, feel my *agrabaaram* as you make this too.



Ingredients

For blending :

- Nei* | Ghee | 1 tablespoons
- Kadalai Paruppu* | Split Chickpeas | 4 tablespoons
- Choravina Thengai* | Grated Coconut | 2-3 tablespoons
- Kaanja Milagai* | Dried red chilli | 1-2
- Kothamalli podi* | Coriander powder | 2 tablespoons
heaped
- Toram Paruppu* | Cooked Pigeon Peas | 3-4 tablespoons

For Sambar:

- Nei* | Ghee | 2 tablespoons
- Perungayam* | Asafoetida | 1 pinch
- Kadugu* | Mustard seeds | 1 tablespoon
- Milagai Thool* | Chilli flakes | 1 pinch
- Karuwepellai* | Curry leaves | 8-10
- Chinna Vengayam* | Shallots/ Pearl onions | 10-15
- Thakkali* | Tomato | 1 large or 2 medium
- Puli* | Tamarind paste | 2 tablespoons
- Manjal Podi* | Turmeric | 0.5 teaspoon
- Uppu* | Salt | to taste
- Kothamalli* | Coriander chopped | garnish



Recipe

1. Add ghee to a large, deep bottom pot. As it heats up and melts, add asafoetida, mustard seeds, chilli and curry leaves. Let it splutter and crackle.
2. To this, add shallots and keep tossing. As you notice the color of the shallots slowly turning from pink to white with streaks of gold, add tomatoes and keep frying.
3. As tomatoes slowly get mushy and soft, add tamarind paste, turmeric and salt. Mix well till tomatoes and onions get coated completely.
4. To this mixture, add about 1.5-2 cups of water, close lid and boil for 5-10 mins.
5. Now for the coconut blending, add ghee to a pan and as it gets hot, add Chickpea lentils.
6. When they turn slightly brown, add grated coconut, coriander powder and red chilli and fry till coconut turns slightly golden.
7. As this mixture cools, blend with a little water to a slightly coarse paste.
8. Now add cooked Pigeon peas with a bit more water and blend to a wet batter consistency.
9. Add this mixture to the boiling sambar pot, and boil for another 4-5 mins, or till you see the color of the sambar darkening a little.
10. Add chopped coriander and serve hot with white rice, vadais, idlis or dosais

05

Spring 2022
Studio III

Beyond Dystopia: Seeking New Avenues for Redemption at the Salton Sea

Instructed by Gary Bates and Elie Zeinoun

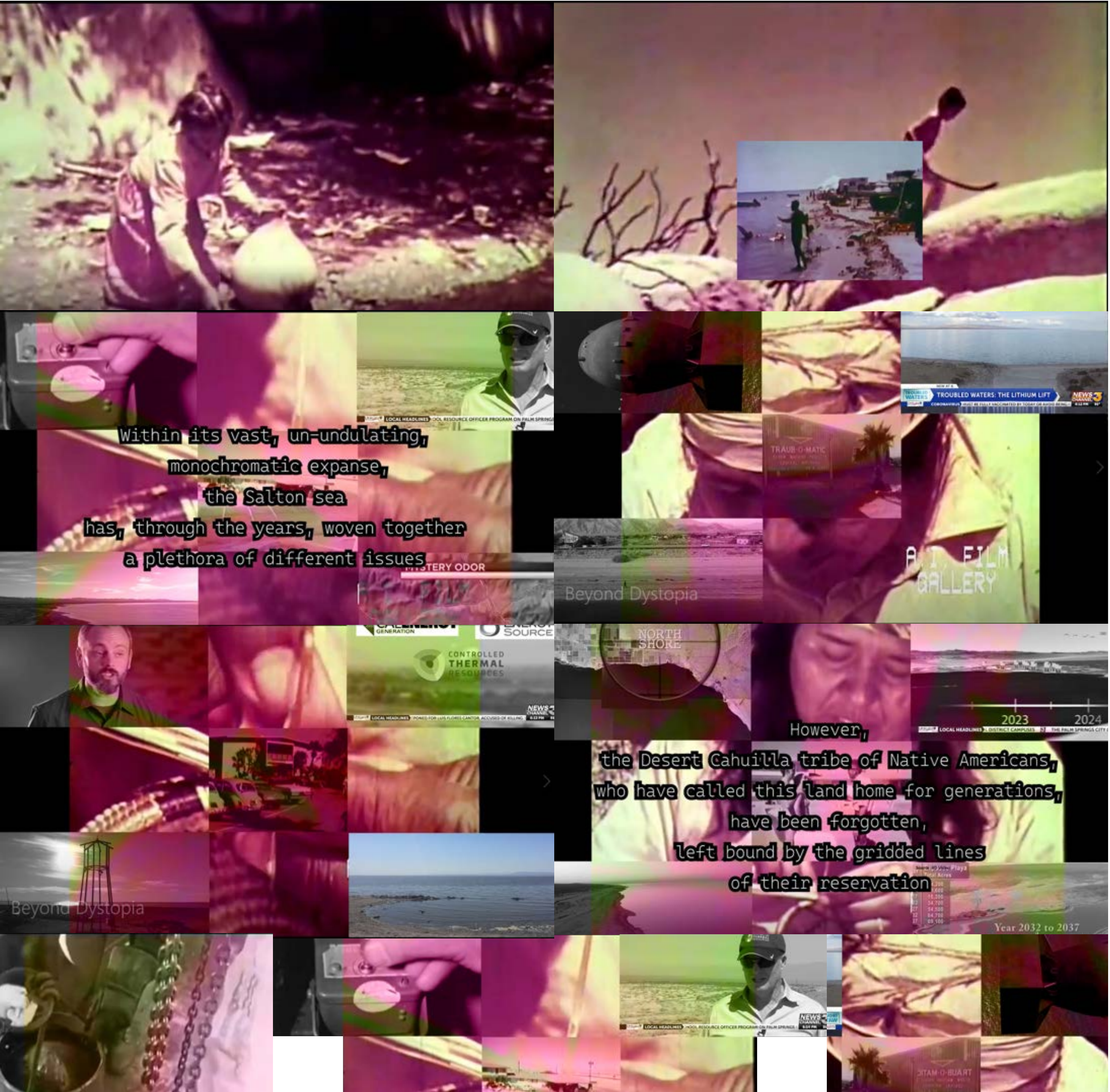



Dystopic Photographs of the ruins at Salton Sea,



Dystopic Photographs of the ruins at Salton Sea,

The Salton Sea is the largest inland lake in California, formed completely by accident when water from the Colorado river was made to rush into Salton, and had no outlet. With time, a tourist attraction slowly started taking shape, immediately monetized through the development of Salton city. The vision for was clear: A bustling, resort community along the crystal blue waters of the Salton Sea. Residents could enjoy their own boat docks and stroll down palm tree-lined streets to the beach. However by the 1980's, after the salinity of the water increased considerably, the city's reality turned more grim. Residents who were thought to live in paradise realized that their elysium was swiftly transitioning to purgatory. A mass exodus materialized, leaving a post-apocalyptic ghost town behind, replete with rotting mid century modern houses, palm tree stumps and a still beautiful, yet very malignant, Salton sea. Today, the Salton sea is frequented sparingly, mostly by photographers and movie makers, to capture the quiet beauty of the rot. However, what about the people that continue to live here?

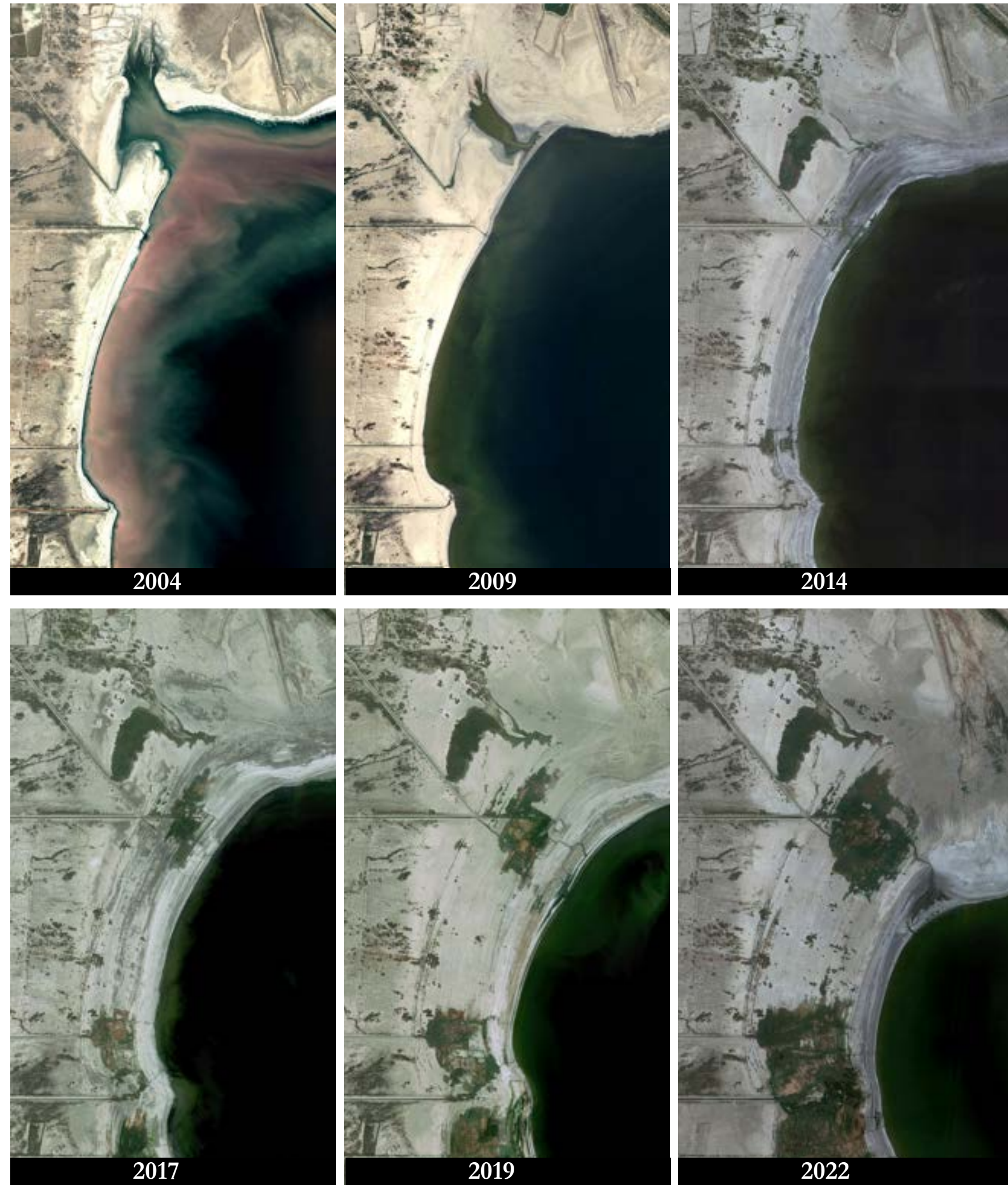

The Torrez-Martinez Indian reservation, half of whose 22000 acre reserved land lies below the “accidental” salton sea, live in abject poverty, with limited access to education, jobs and resources. While these people have lived here for centuries, they still find it difficult to lead lives of comfort and ease. One of the major efforts of the tribe as been to create wetlands along the receding coastline, so as to prevent the exposure of the toxic sea bed. This in turn has facilitated the growth of tiny insects and frogs, while also becoming a major pittstop for migratory birds, making it a complete microcosm of unexpected ecological richness on erstwhile toxic soil. These varied intricacies form myriad entangled layers on the ecosystem that is the Salton Sea. How could we tie all of these together and give the Salton Sea an identity that transcends its Dystopic past or it’s gentrifying future? How could redemption/ rehabilitation in turn be possible for the Torrez Martinez tribe? This is the aim of ‘Beyond Dystopia’



The project begins by augmenting the existing wetlands: excavating the earth and filling the mounds with water. From there, the operations are threefold: to create opportunities of livelihood, housing and food for the Torres Martinez tribe. The dune-like houses are constructed using adobe bricks made from earth excavated to create the wetlands, peppering the expanse with colonies and communities in varied configurations. The opportunities for work are created by the introduction of an upcycling facility on site, that collects construction waste and materials from all the dystopic ruins and repurposes them for more functional applications. Lastly the adoption of community kitchens, as opposed to full fledged kitchens in individual homes not only allows for minimization of food wastes and resources, but also facilitates the strong sense of community and desert Cahuilla pride to be kept alive through mutual interactions on a daily basis. While conventional, gimmicky notions of native American tourism are kept at bay in this project, it could provide tourists a realistic glimpse of the precarity of life at fragile ecosystem, and the meticulous systems the desert Cahuilla people have in place to fight the odds and emerge stronger

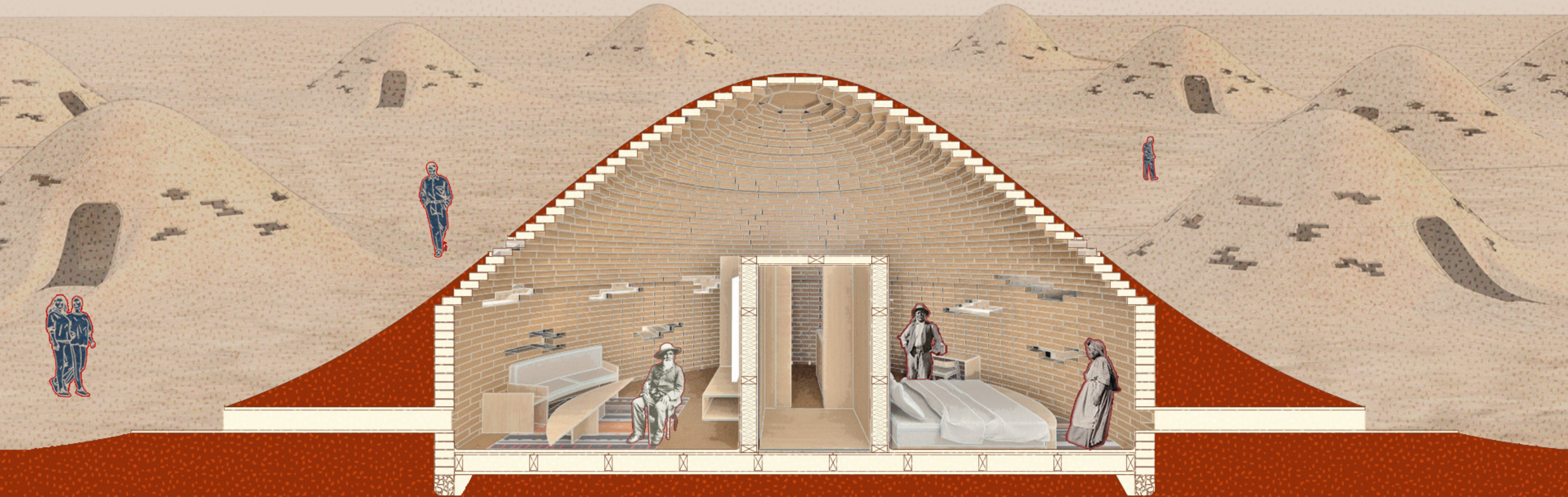



Housing unit plan

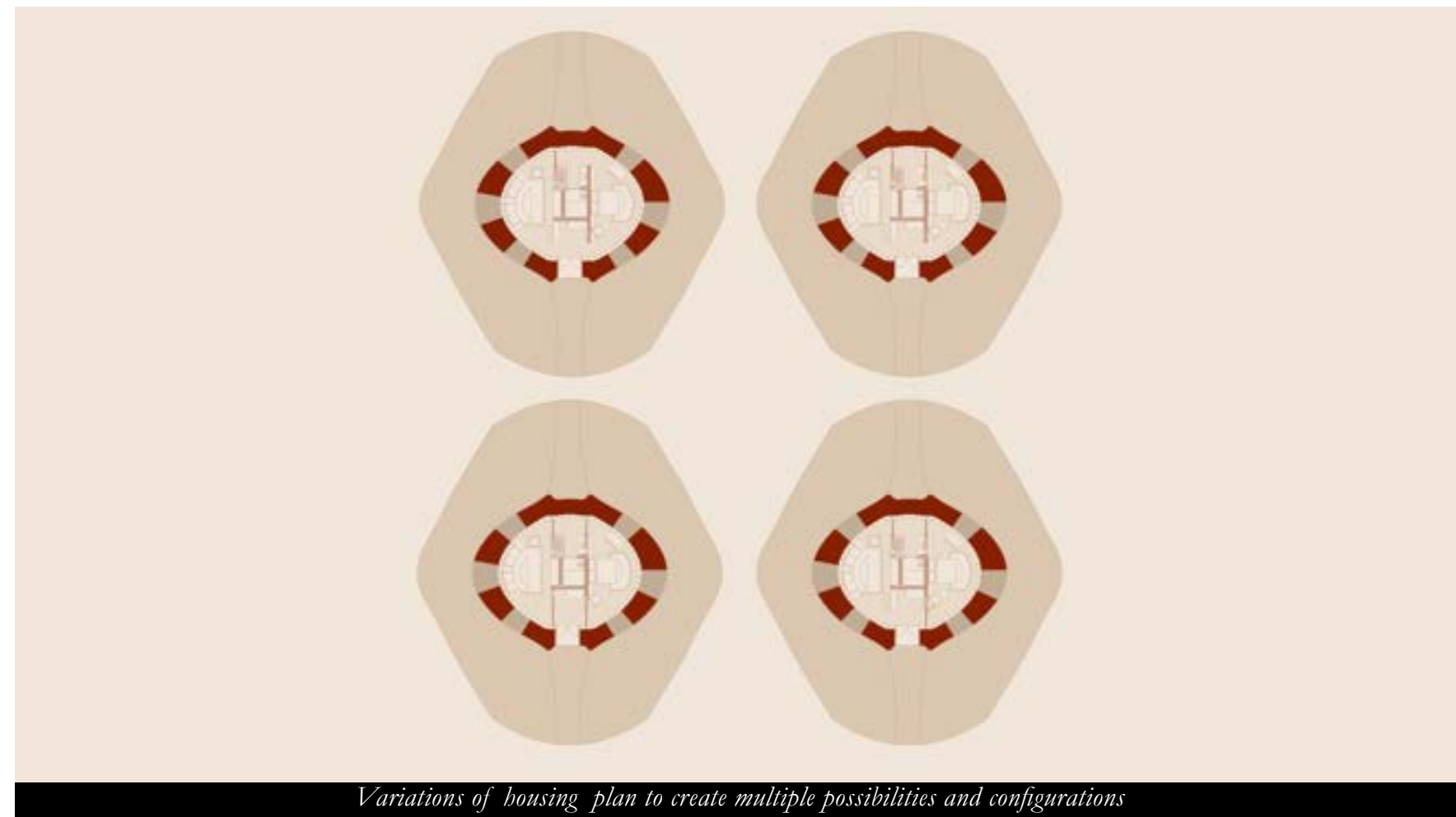

Variations of housing plan to create multiple possibilities and configurations

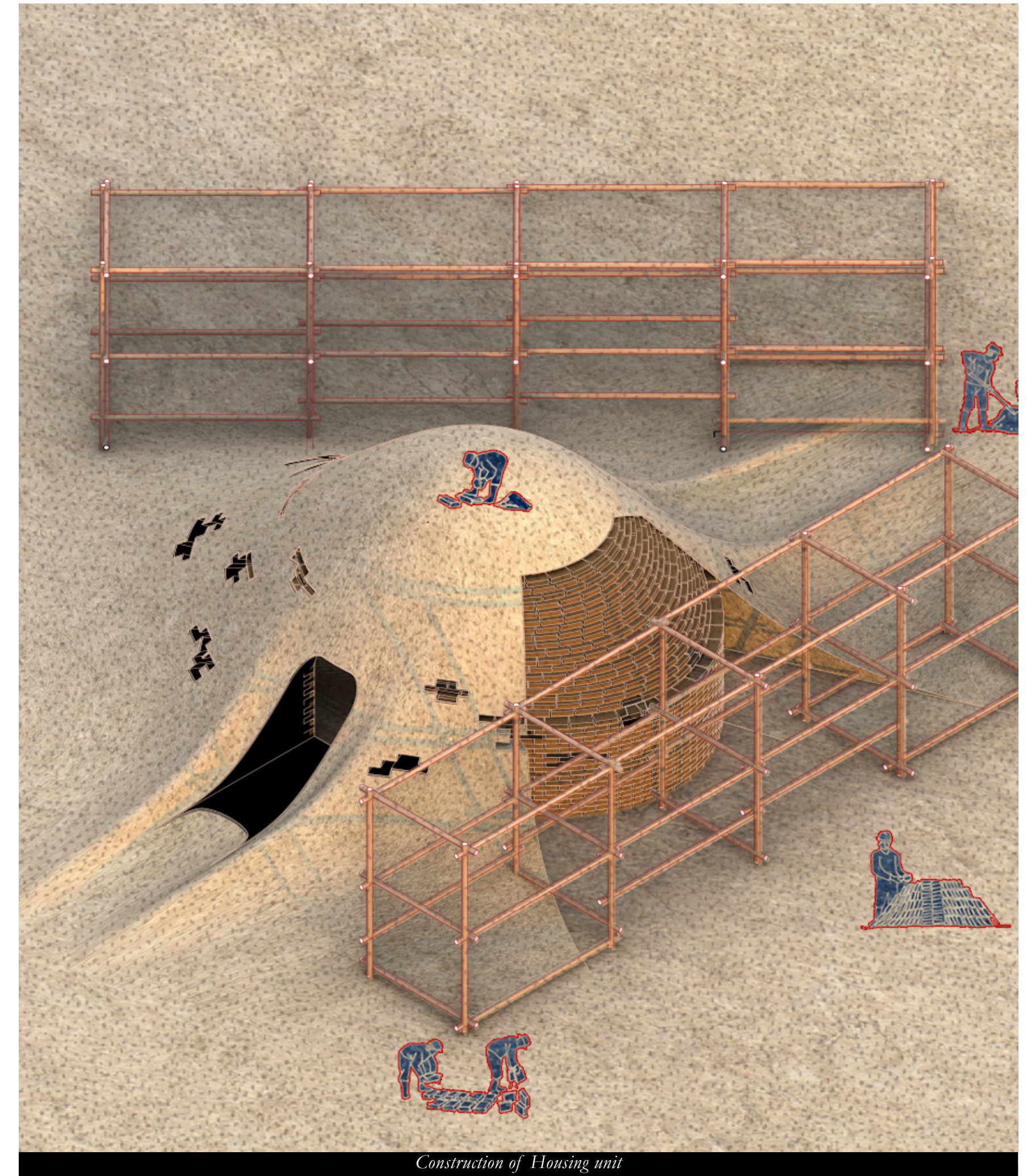

Construction of Housing unit



Exploded Axonometric of Upcycling Factory

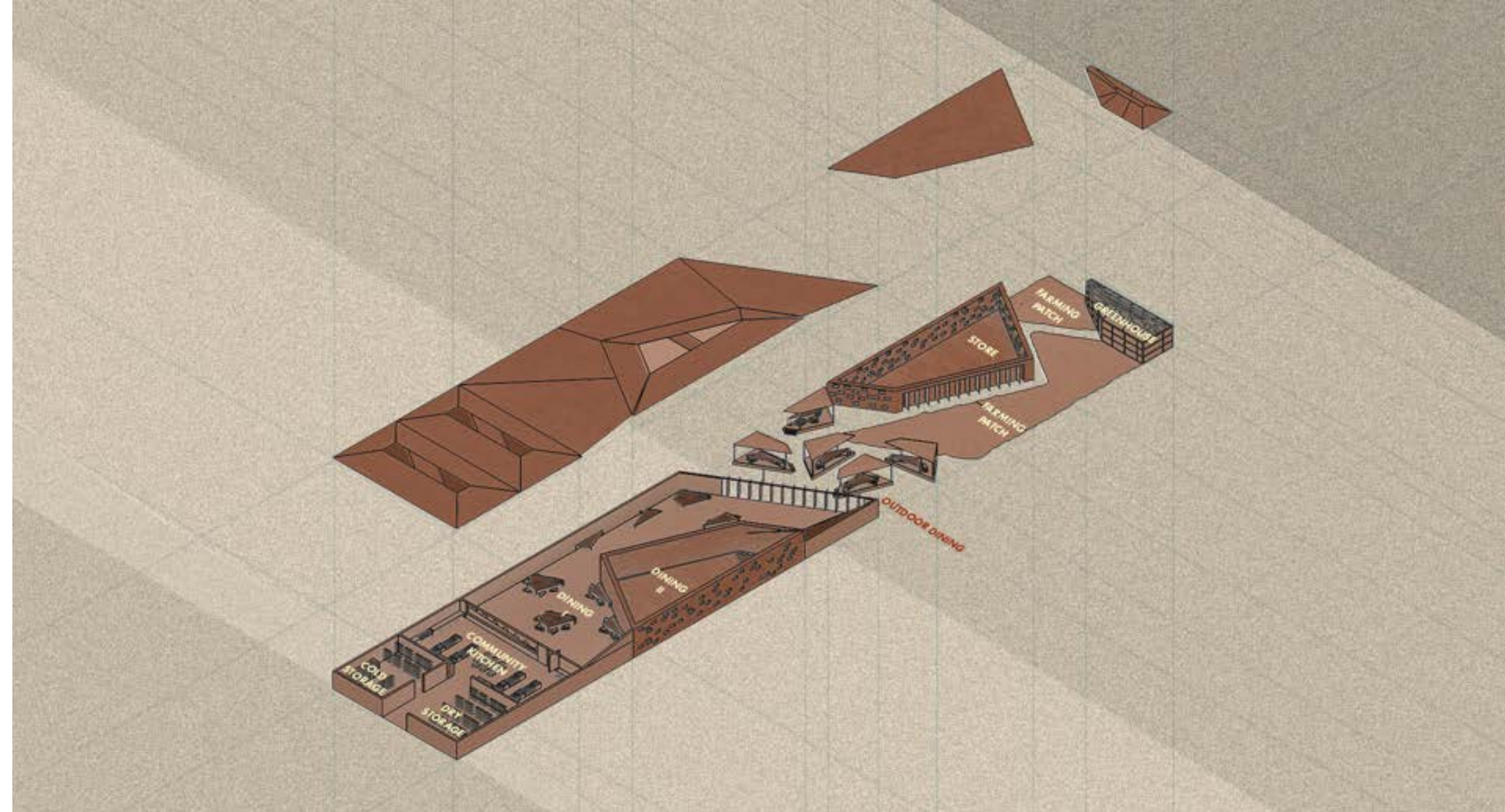

Exploded Axonometric of Community Kitchens and Dining Spaces



Rendering of Upcycling Factory



Rendering of Community Kitchens and Dining Spaces





Clamping plywood to copper



Creating houses by wet bending veneer



Final output

06

Summer 2021
Transscalarities | Assignment I

Can we be Dreamers of a Utopia That Exists Within the Dystopia?

Instructed by Andres Jaque and Malcolm Rio

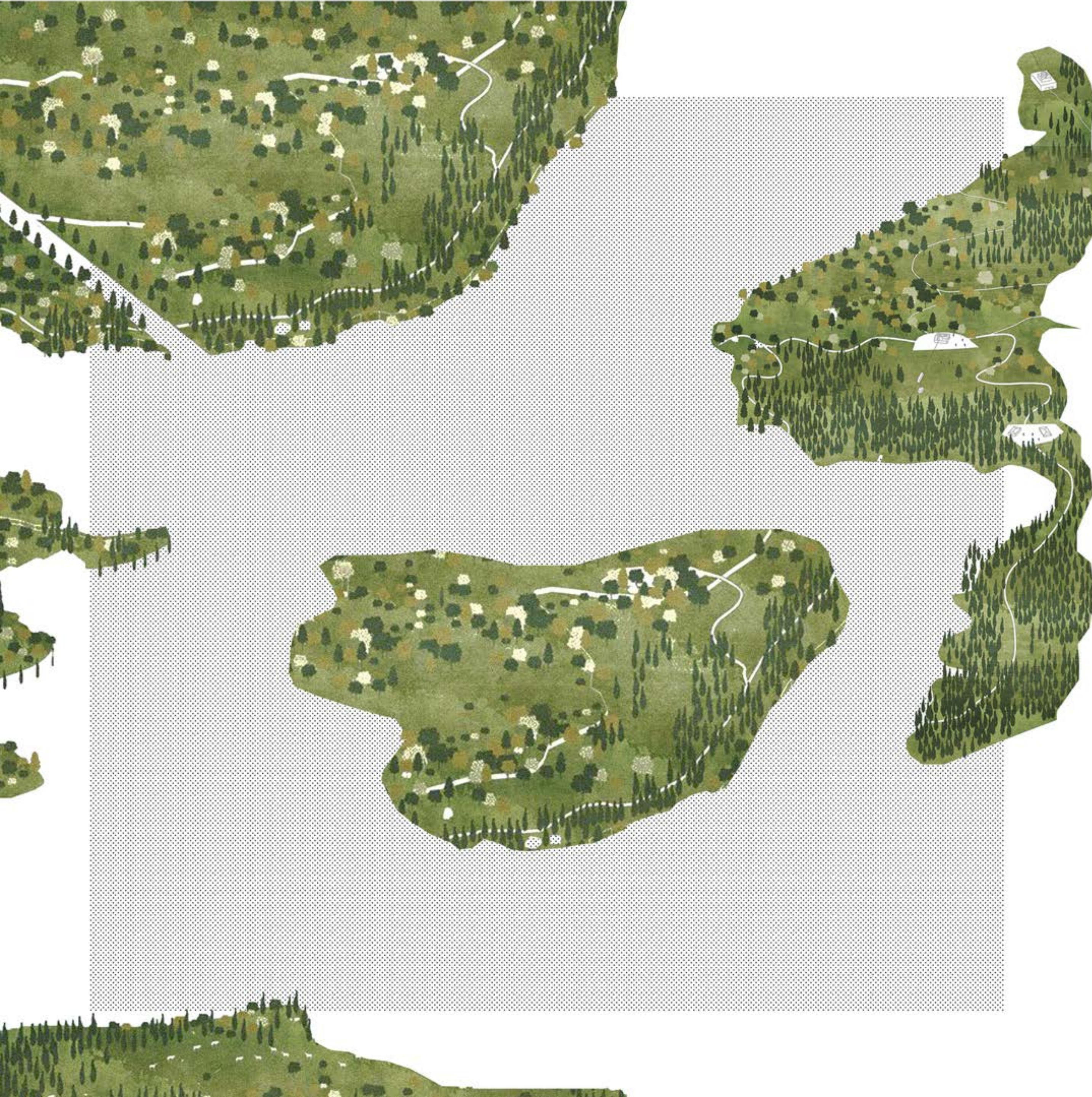



Hieronymus Bosch, "The Garden of Earthly Delights", oil on oak panels, 205.5 cm × 384.9 cm (81 in × 152 in), Museo del Prado, Madrid

As architects, we are constantly striving for utter and absolute perfection. We find ourselves re-designing our work countless times to try and arrive at that much coveted sweet spot, only to find ourselves never fully satisfied or convinced. While the search for utopia never ceases, there always exists an alternative reality that we tend to ignore: of disarray, chaos, calamity and confusion. Not far removed from Sci-Fi Movies, we might visualise a time when relentless wars and epidemics have wiped out the human race in almost its entirety. Bustling metropolises, the towers of which once embellished the night sky, now find themselves in chaotic lifelessness, left to decay in desolation. While culture finds itself caught within the realms of ruin, nature flourishes with the decline of human impact. We find rare flowers blossoming and newly evolved species surfacing with a renewed lease of life; a much-warranted return of the wilderness, to stake claim upon encroached land. Normalcy, as understood presently, has ceased to exist, paving the way for a new normal. A palpable calmness that emanates from the harrowing ruins of mankind taken complete hostage by nature.



An example of the abovementioned *renaissance* of nature, and its looming collapse, was witnessed when an abandoned rainwater basin in Tempelhof, Berlin, surrounded by a 19th century *gartenkolonie*, was tenanted by a peculiar structure. Composed of scaffolded volumes and inflatable rooftops, author George Kafka, defines it as “part-pirate ship, part-Princeton; part-Archigram and part-Burning Man.” Polemics aside, this was the ‘Floating University’ by Raumlabor: an offshore urban laboratory to facilitate networks between disciplines, challenging the monotony of urbanity. The idyllic setting of this project was chosen to serve as a reflection of past bounties, reminiscing a time when people could even drink from the basin, while also mirroring the scarcities and struggles of a not-so-distant future



Raumlabor, “Floating University”, 2019, © Alexander Stumm



Malte Jensen, "Tempela National Park", Digital Montage, 2019

Prior to the university's inception, the isolated water basin and farm had coalesced into an ecosystem of their own, supporting relationships of flora and fauna otherwise unheard of. The artist Malte Jensen went one step further and imagined the site as an extension of the Berlin national park. Almost mimicking teleportation to an African safari, the fascinating montaged images of 'Tempela national park' show hordes of lions, zebras, giraffes, and rare birds that flock towards the basin and interact with each other.



Malte Jensen, "Tempela National Park", Digital Montage, 2019



Dhruba Lakshminarayanan, "Under the Basin", 2021

While one might argue that the Raumlabor interpositional has introduced another layer of complexity to this diorama, it has been detrimental to its earlier workings. Aquatic species are now scared off to deeper rungs by strange hybrid experiments floating alongside them. Come nightfall, the university lights up in bright colours, wreaking havoc for nocturnal species that call this home. What has disturbed status quo the most, however, is the worldwide acclaim of the university, bringing hundreds of thronging visitors into the equation. So where does one draw the line between land-use and disruption? Having arrived this close to rehabilitation, and a sense of obscured redemption for humanity, is this university an adequate tipping point to annihilate new-found equilibrium? Are we on the road back to dystopia?



07

Fall 2021
Studio I

Welcome to
Coddle Critter Crest

Instructed by Ersela Kripa and Stephen Mueller

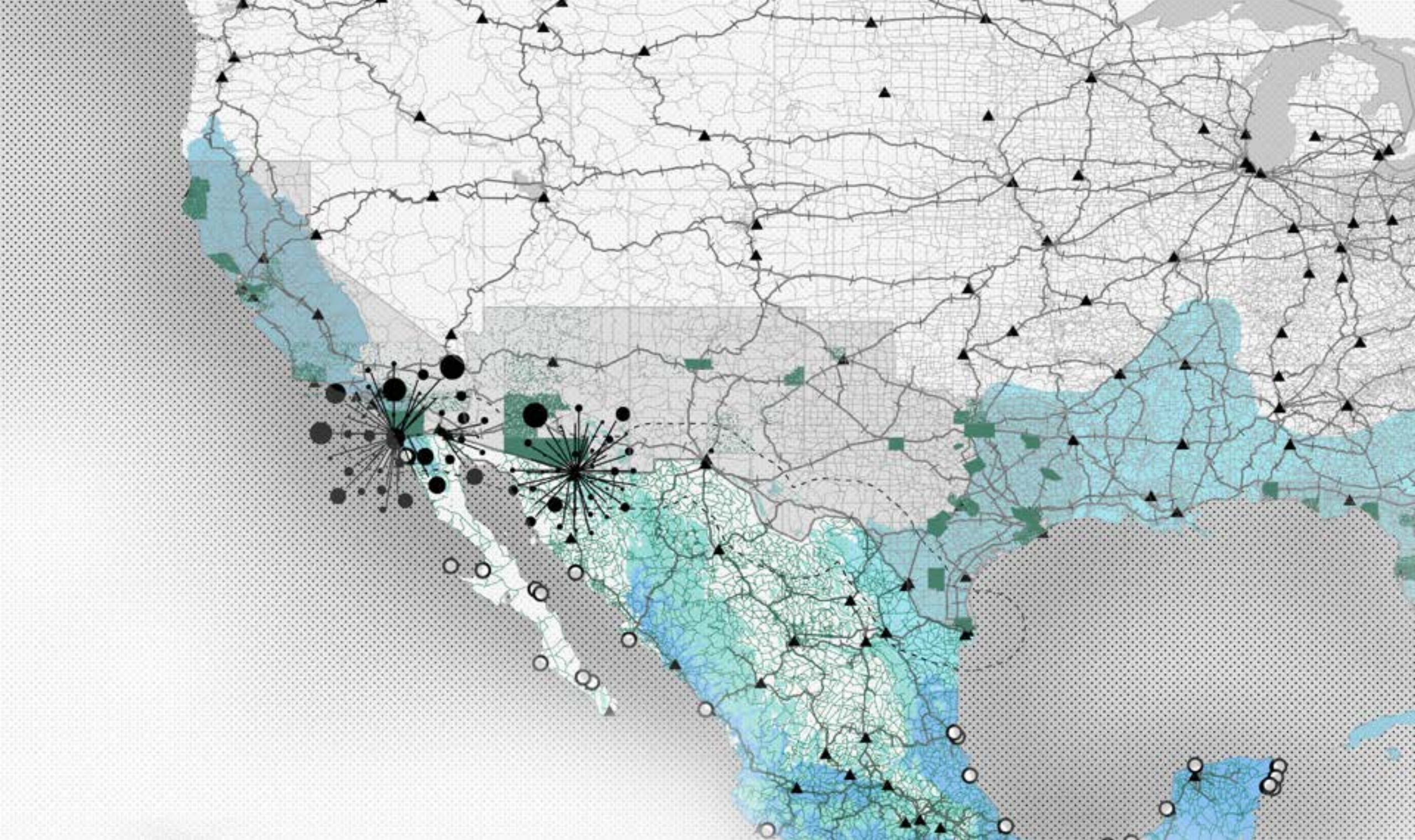

So picture this: There are more tigers in US suburbia than in the wild worldwide. Let that sink in. This obsession with owning an exotic pet to allude to elevated status or to tame the untamable is indelibly rooted to our psyche. Even on TikTok or Instagram, our feeds are often populated with influencers who prance or swim around with their wild pets for pleasure, likes and followers. However, behind this charade lies a clandestine world of pricing, packaging, illegal border crossing, brutal auctioning and much more. Abducted from the wild days into their life, these bottle-raised animals are blissfully unaware of other realities. If released back into the wild, they stand absolutely no chance, endangering their own lives and the lives of fellow humans. Sending them to rescue centres/ shelters is also a risk, as such places often double up as illegal breeding operations, further enabling the exotic pet fetish. So, given the inherent reality of backyard exoticism In US suburbia, and the capitalism that ensues, how can a future where animals live less like status symbols and more for themselves be facilitated?

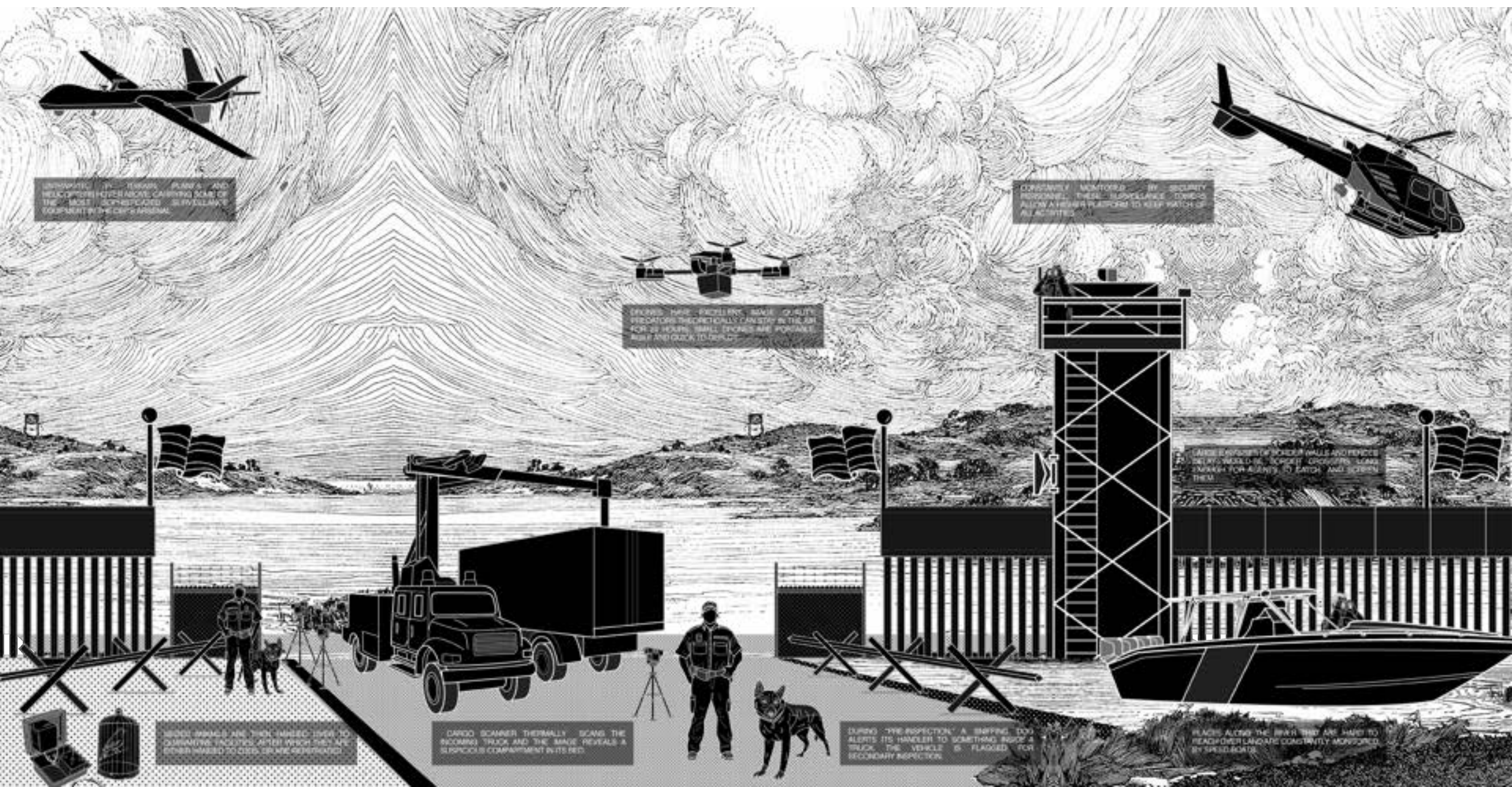

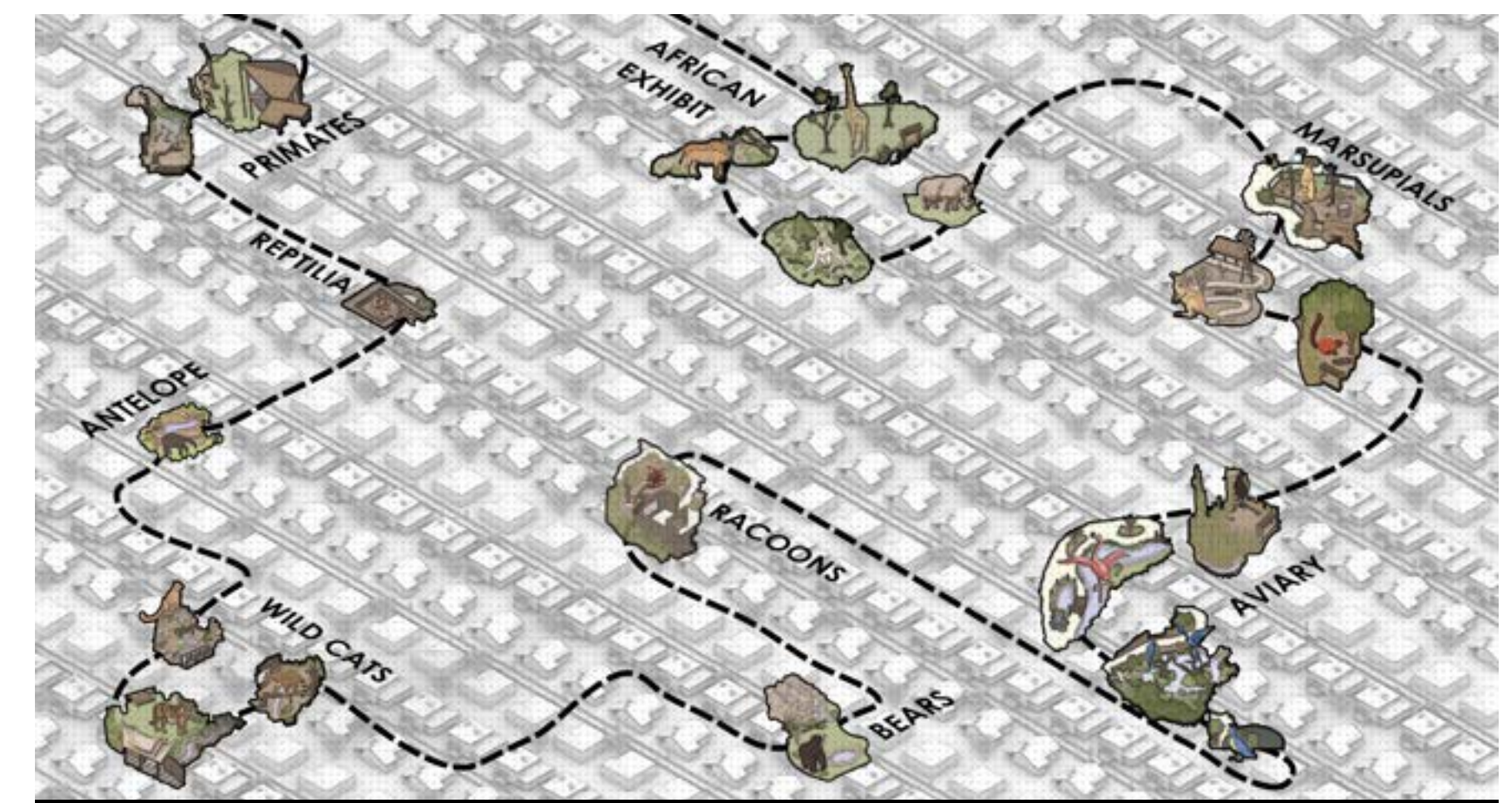
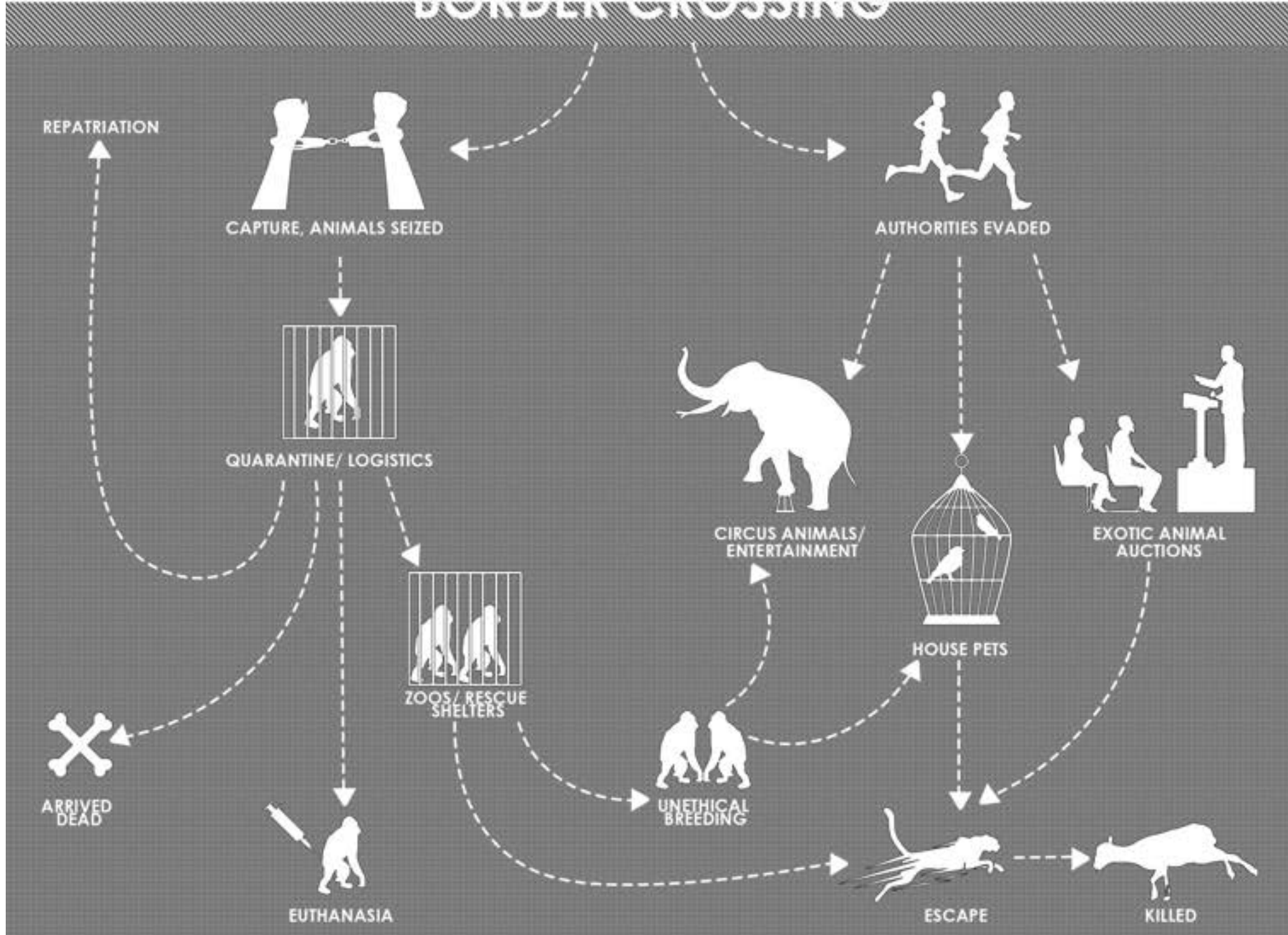
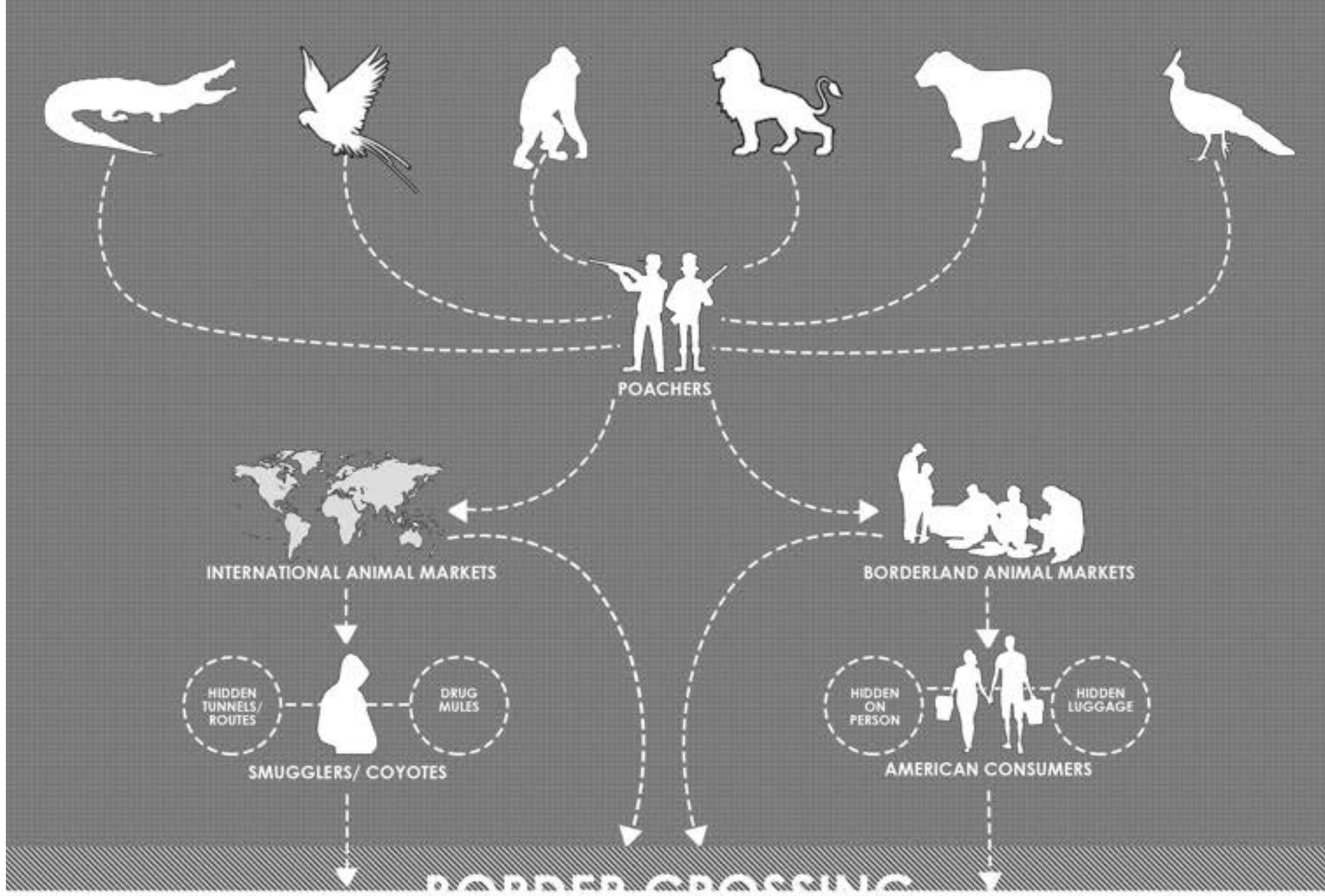

The 'Zooification' of Suburbia visualized at the current rate of illegal wildlife acquisition

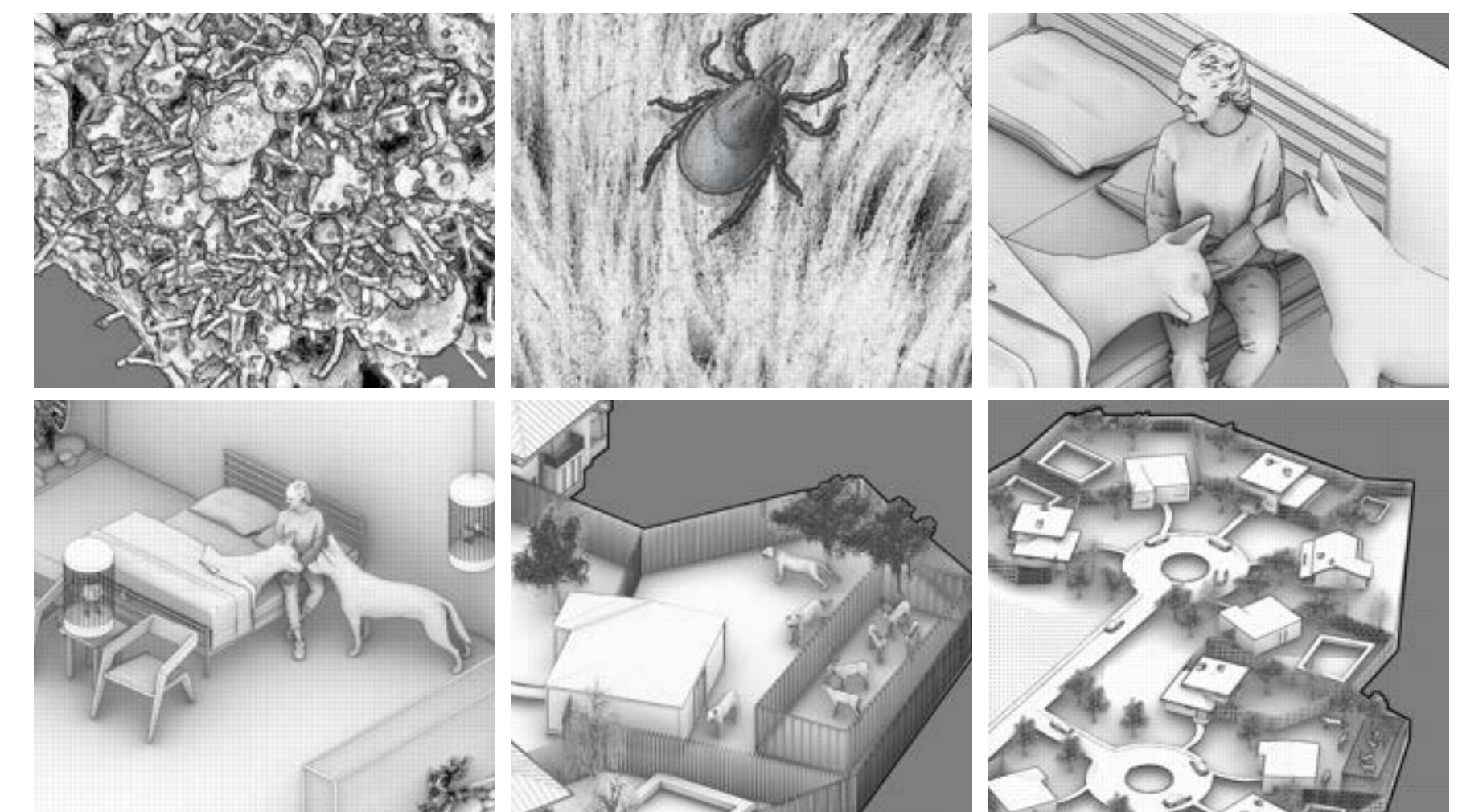

Zooming in and out to see the problems of backyard exoticism at various scales

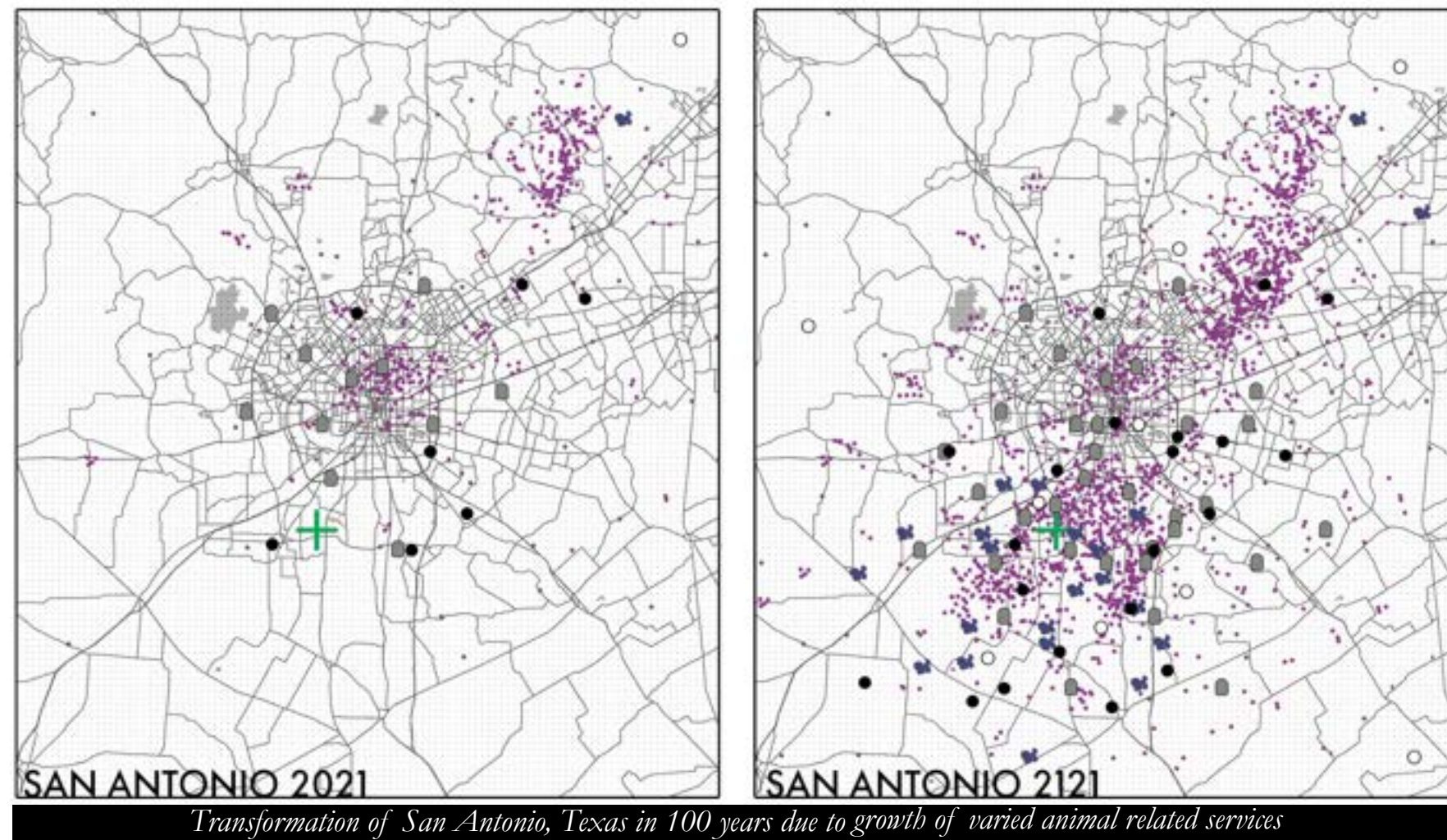
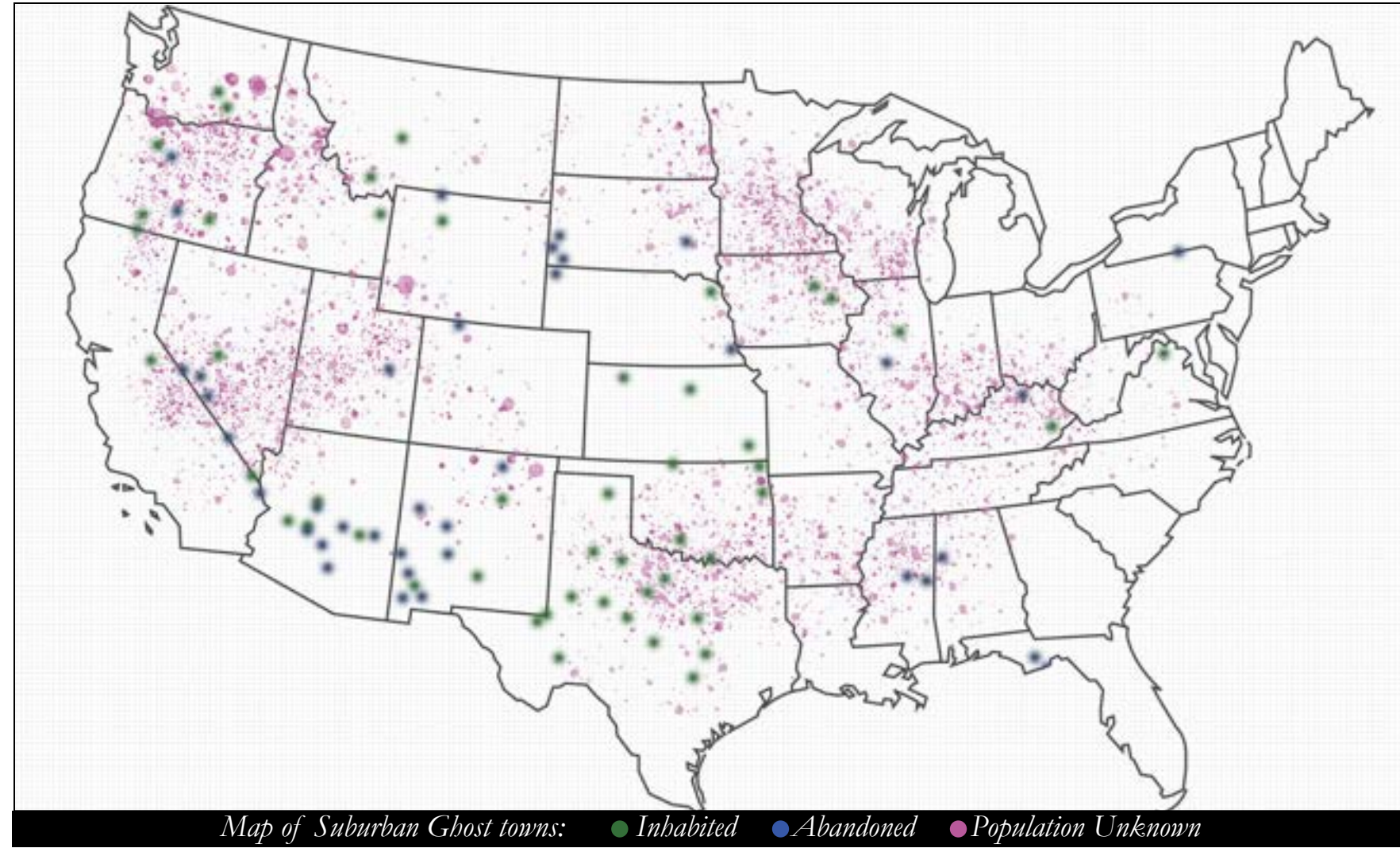

In addition to the exotic pet fetish, the US today also faces an onslaught of abandoned, isolated suburban ghost towns, generally consisting of larger-than-life houses, with tons of backyard space, that the government has no idea what to do with. Therefore, retrofitting these isolated suburbs according to animal needs, could allow for more comfort and autonomy. Pet owners on the other hand could be encouraged through tax incentives, to move here to finally live peacefully with their pets without the constant fear of being caught. Such animal neighbourhoods would also encourage the growth of varied connected services around them, such as slaughterhouses, veterinary services, pet waste disposal, pet cemeteries etc, thereby encouraging more employment. One in ten US homes “own” an exotic pet. While it’s all fun and games for us, in doing so the animals are being stripped off of their true selves, leaving them helpless and vulnerable. Let us therefore cast off our anthropocentric lens for once, to try and provide these animals with the life of dignity they truly deserve.

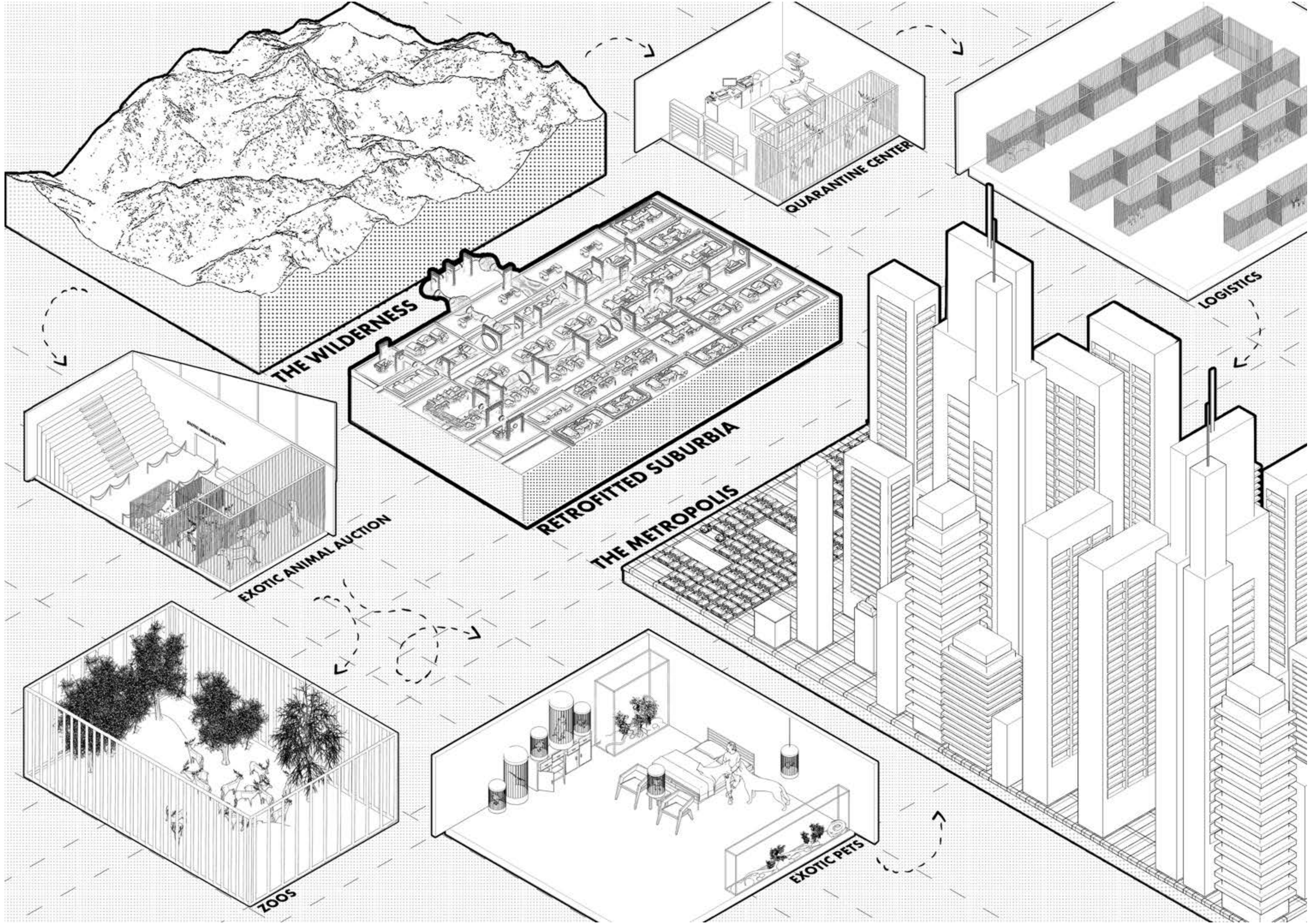

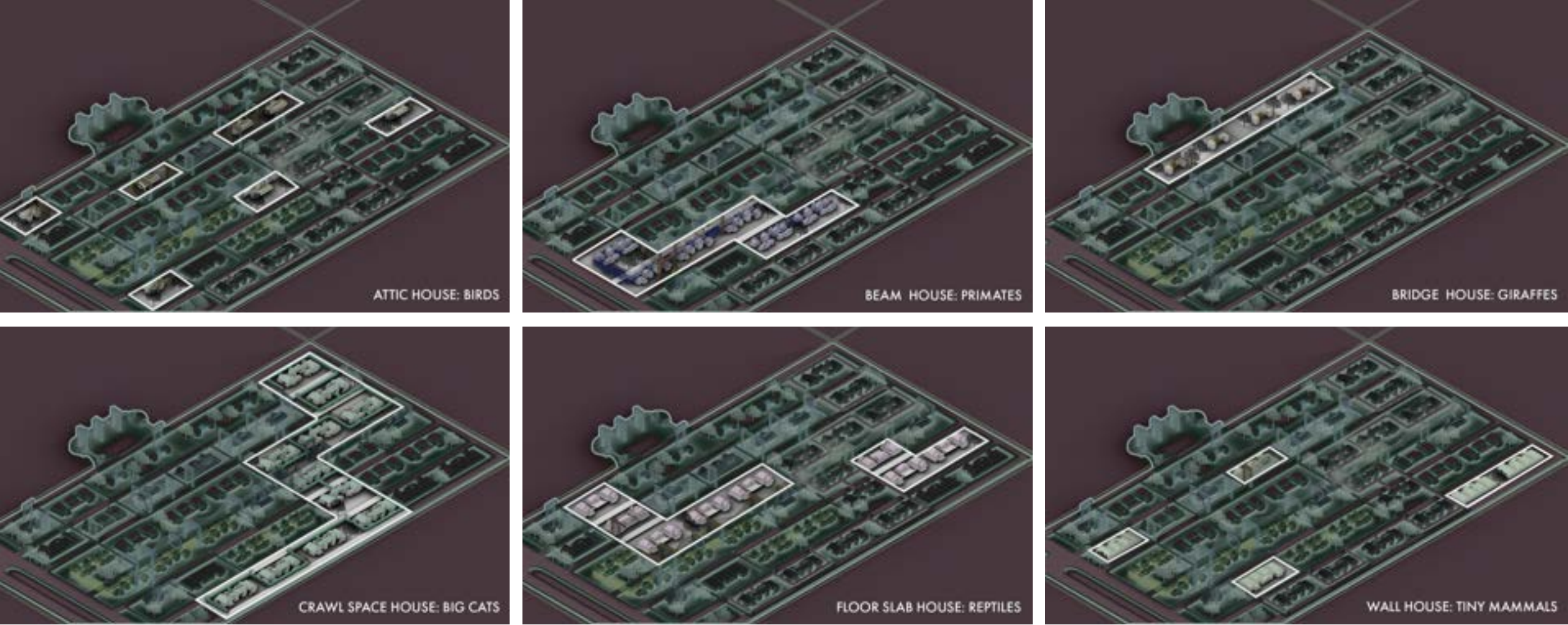

Aerial still from walkthrough film



Close up aerial still from walkthrough film

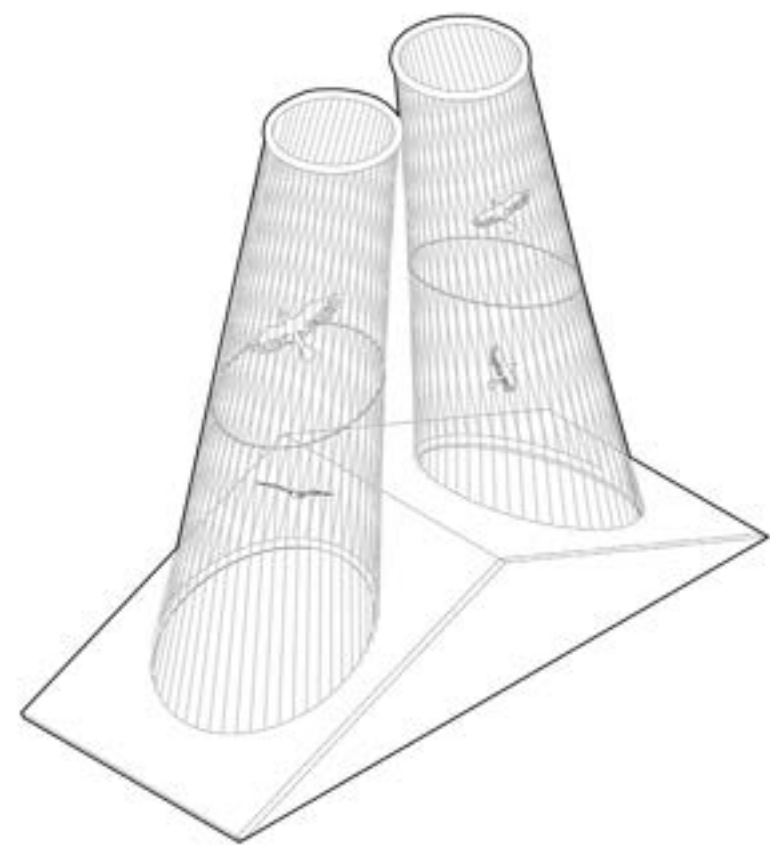

Net to roof connection detail

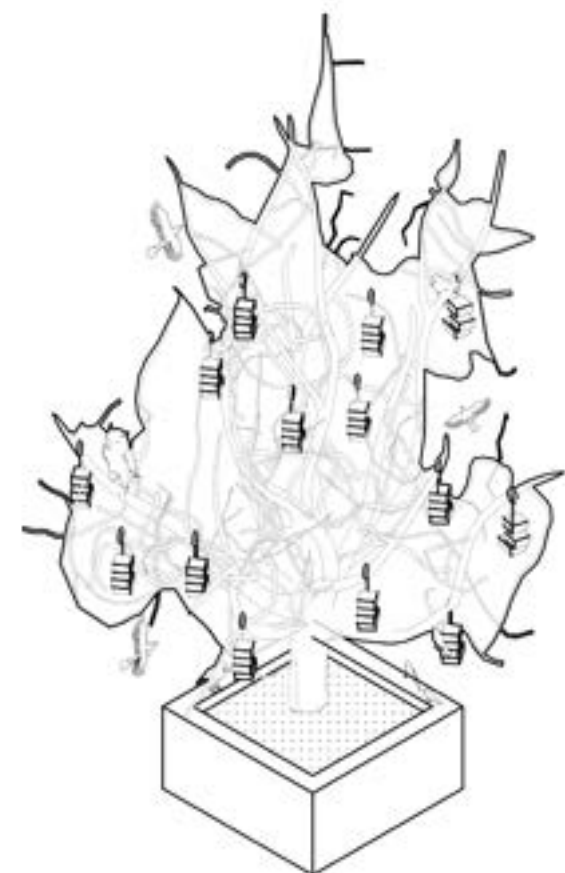

Tree feeder detail

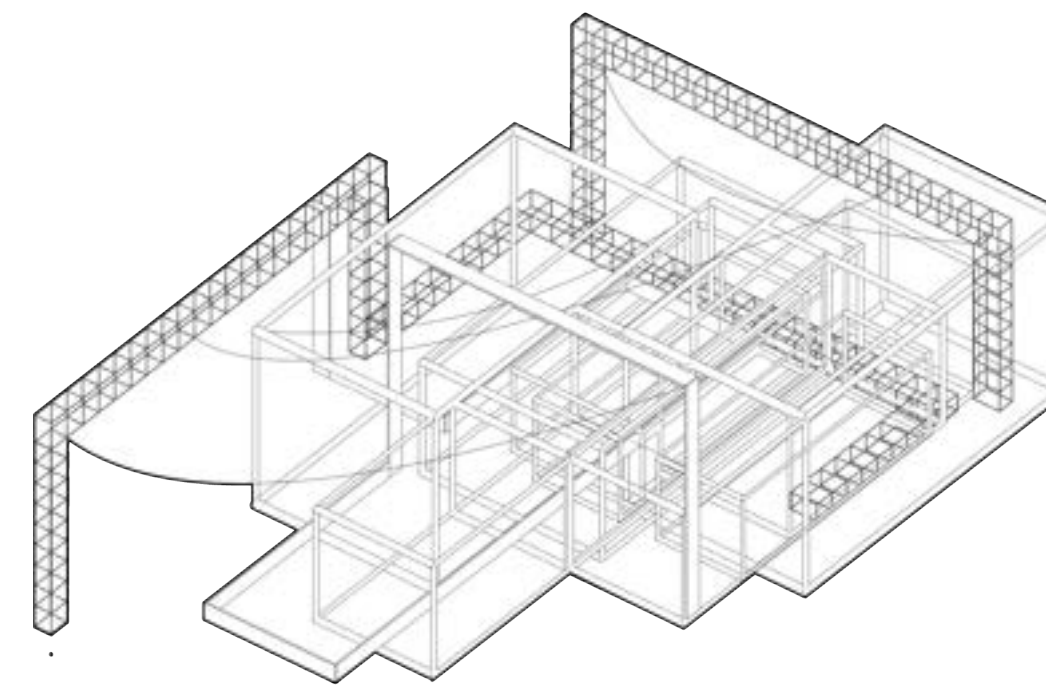

Primate Jungle Gym detail

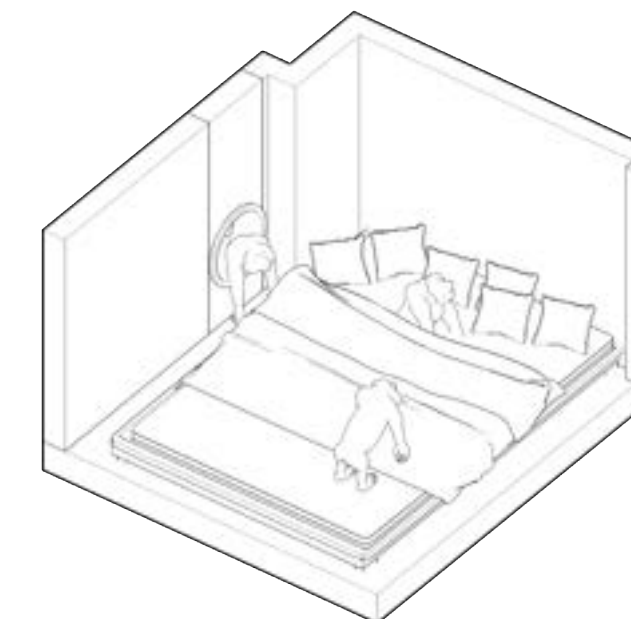

Outside inside connection detail

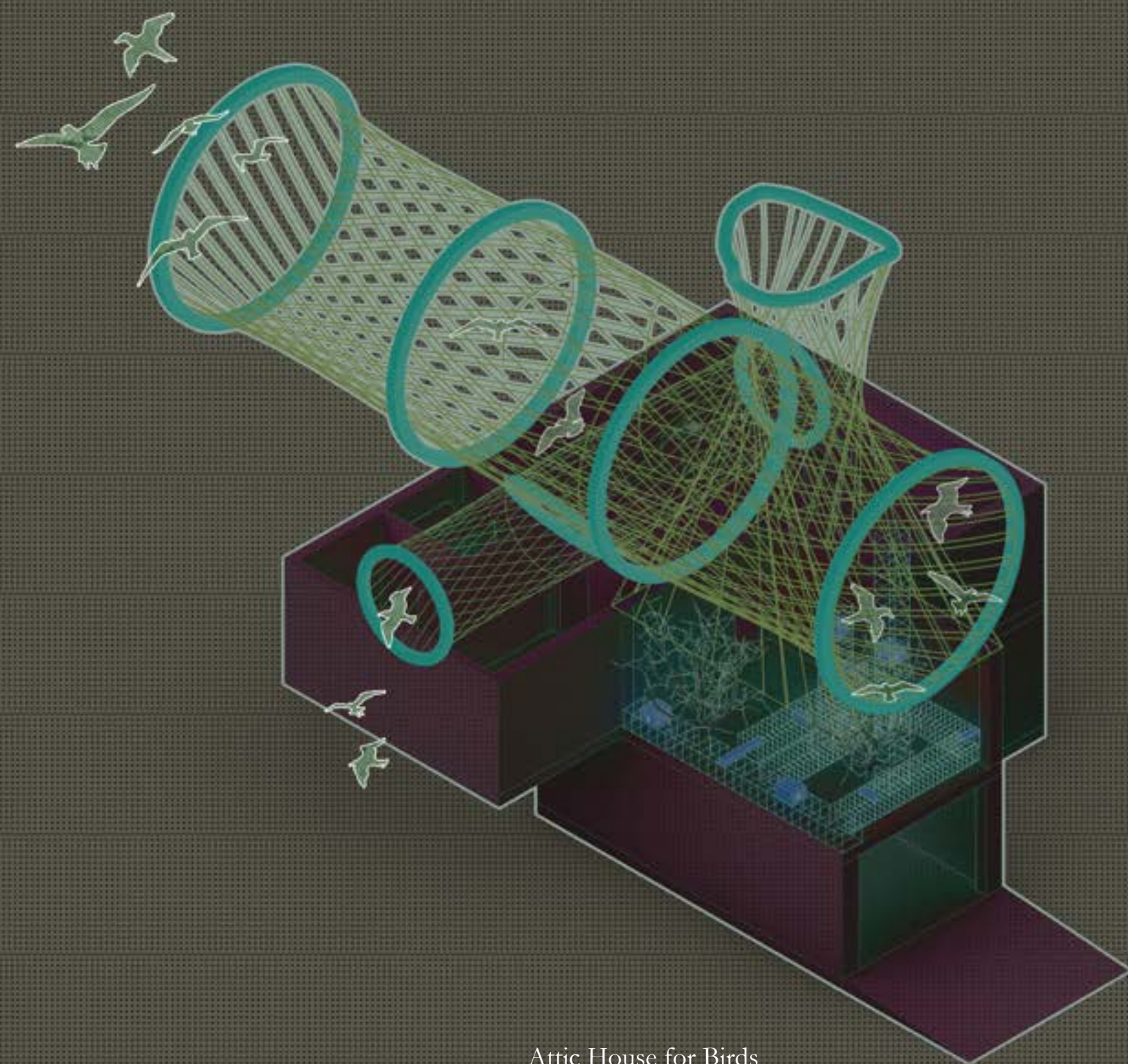

Attic House for Birds



Beam House for Primates

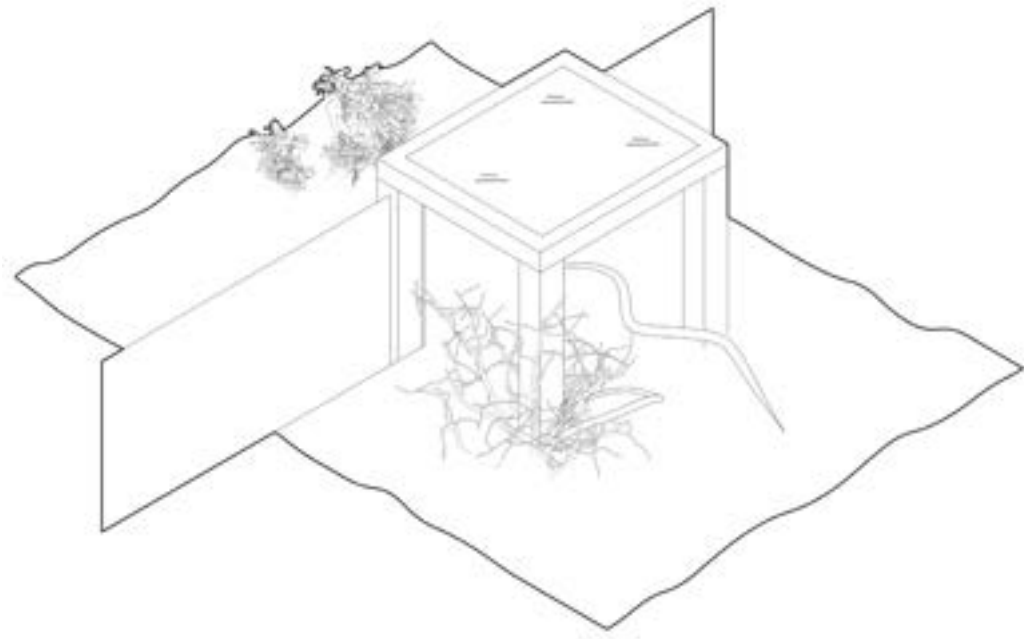

Sub floor microclimate control chamber detail

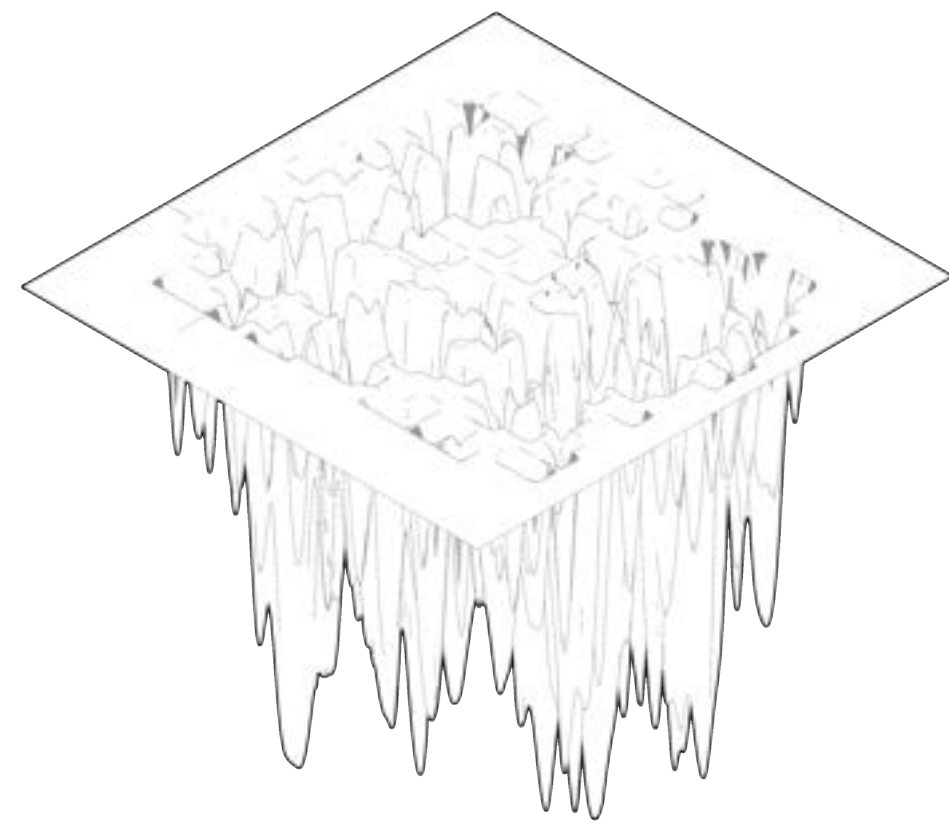

Underground tunnel detail

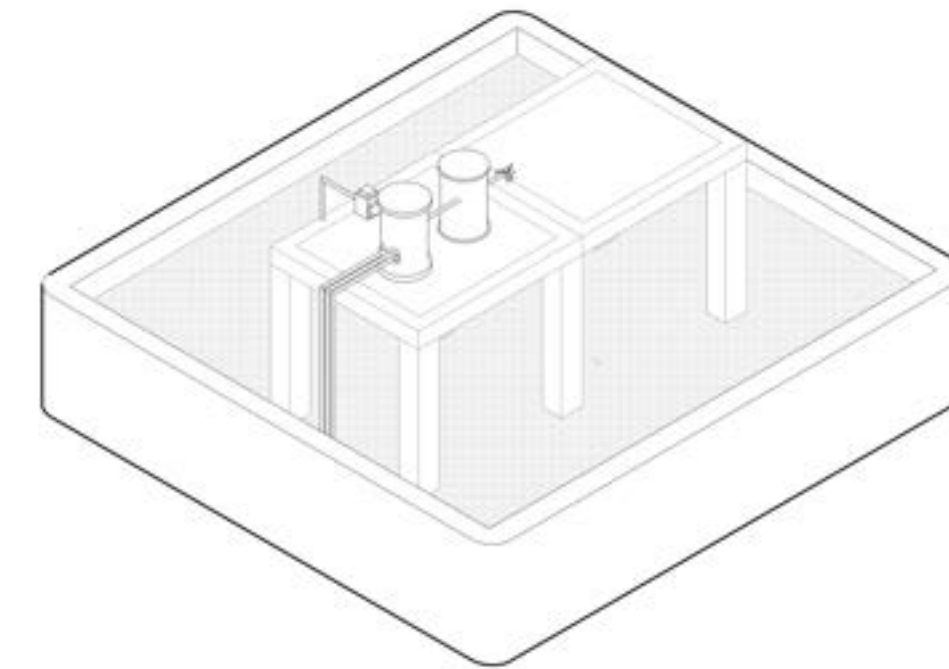

Water Heater Detail

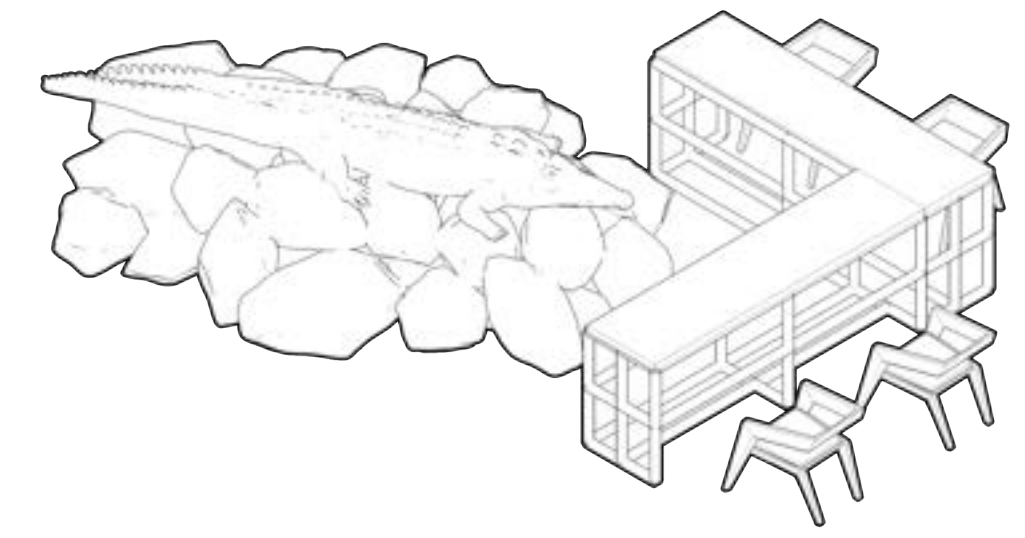

amphibian + human dining table detail



Floor Slab House for Snakes



Deck House for Amphibians

DAYS OF OUR LIVES: PART ONE- ANIMAL
STEP INTO THE LION KINGS BOUDOIR...

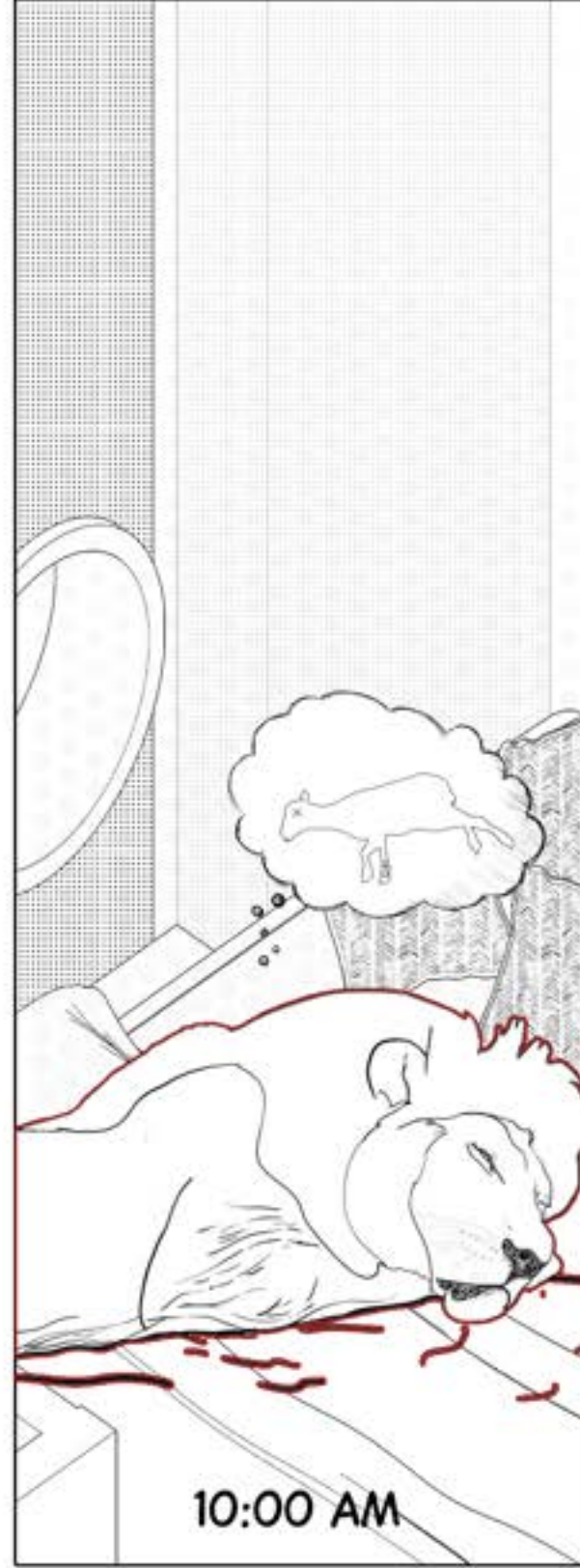

10:00 AM

WASN'T THIS GOAT BIGGER IN MY DREAM?!

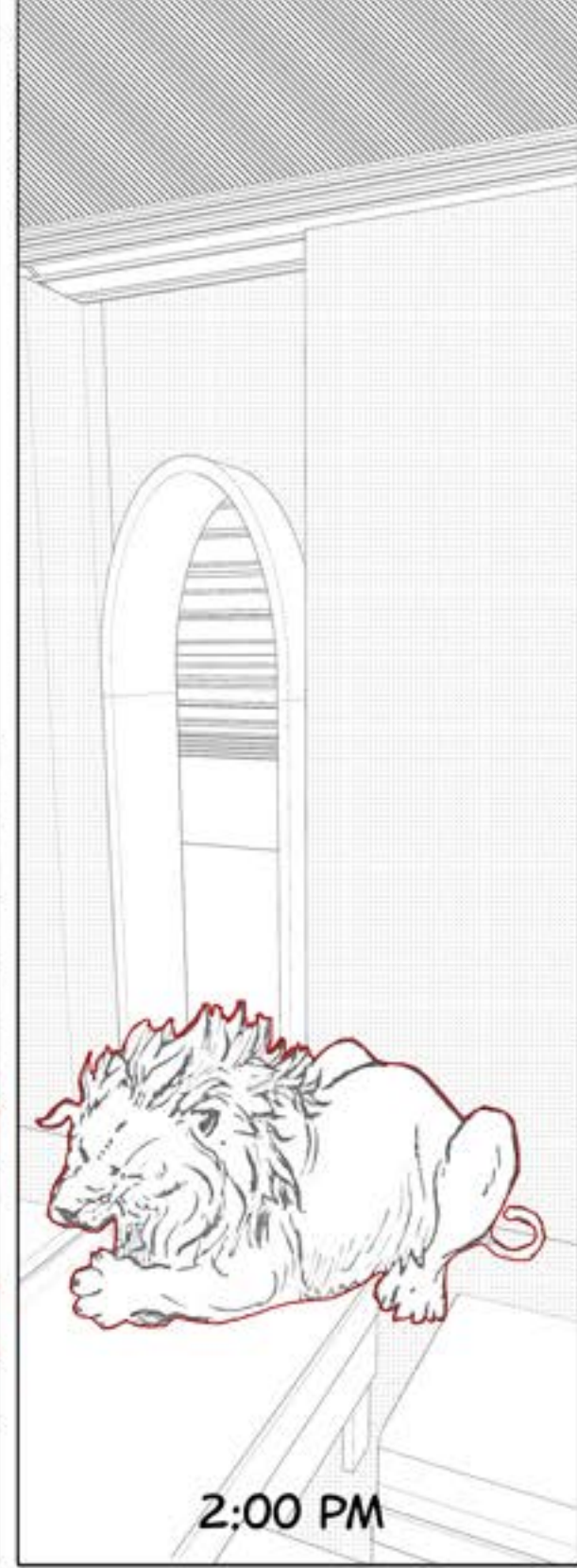

2:00 PM

CURLING UP IN THE CRAWL SPACE...



5:00 PM

MIDNIGHT STROLL TO BE A FLANEUR...



10:00 PM

DAYS OF OUR LIVES:
PART TWO- HUMAN



10:00 AM

MY BABY'S GROWING UP! *SIGH*



2:00 PM

"OMG! 9.8 MILLION FOLLOWERS?!
HIS INSTAGRAM IS BLOWING UP!"



5:00 PM

COME TO BED SOON SON...

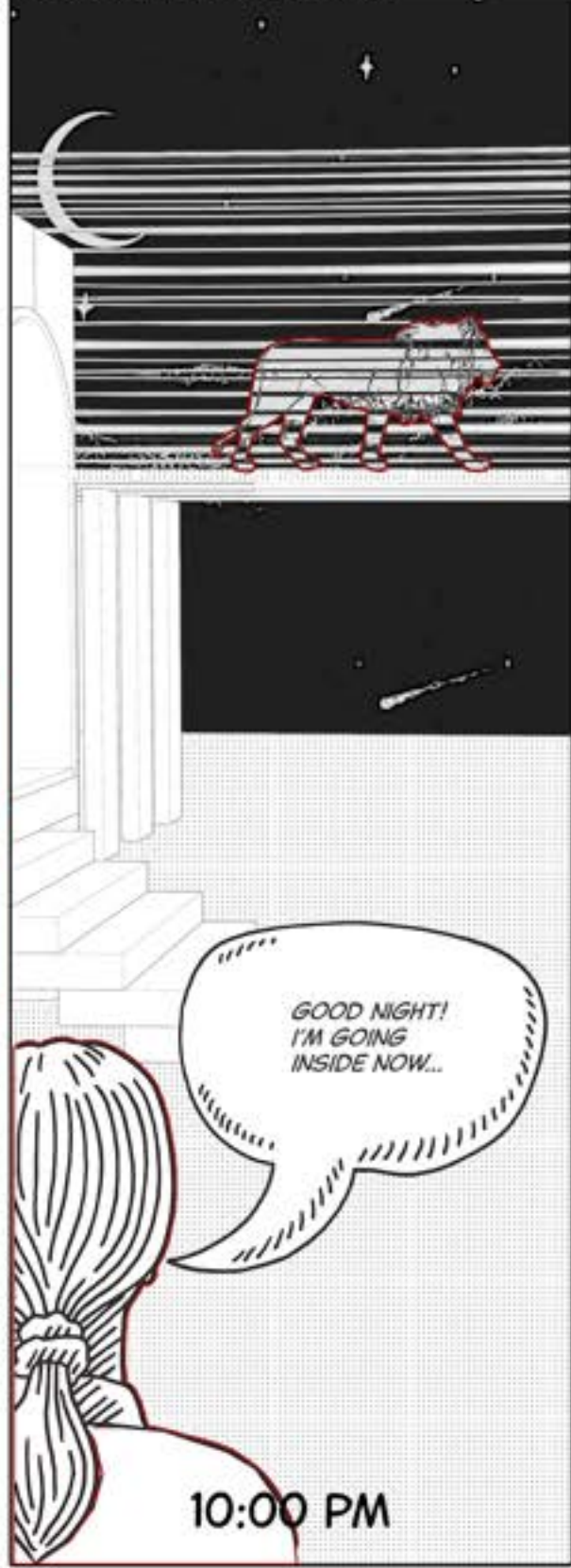

10:00 PM



08

Fall 2021
1:1 Detail | Totem

Anais

In Collaboration with Lina Ramirez
Instructed by Zachary Mulitauaopele

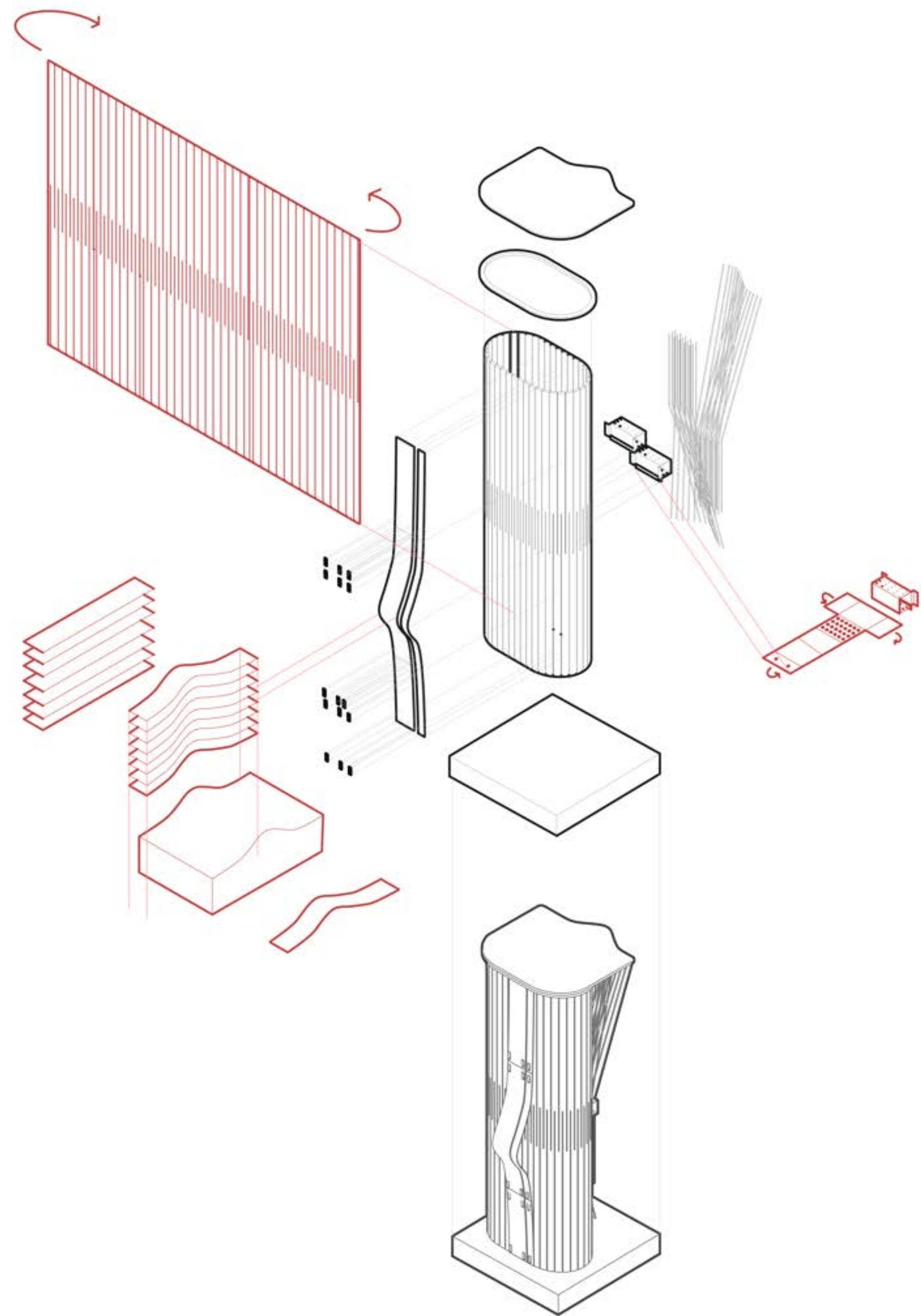

This assignment was thoroughly enjoyable, and a very valuable learning experience as it was instrumental in forcing me to get my hands dirty. Designed as a semester long assignment whereby we were required to design a wall typology element: first a door handle, then a structure, then a skin. A 1:1 prototype, that could then be applied to a larger area. My partner, Lina, and I were keen on one thing right from the start, that we would experiment with a melange of varied materials, allowing us to understand firstly how different materials work on their own, and secondly what detailing needs to be done to allow for materials to come together and function seamlessly. As an overarching design strategy for the semester, we decided to experiment with methods of curving and bending: by laminating and shaping pieces of very thin wood veneer with the use of a plywood jig for the door handle, by creating kerfs on a large piece of 3/4" plywood to make it curve an oval form to create the wall and lastly by bending copper sheet using a metal bender and orchestrating openings within it to pass copper wire to create the skin. Once we were done, we both looked at each other and said, "We should name this! Something French? What about *Anais*?"



Creating the Jig



Clamped Veneers for curved lamination



Nail Gun to fasten wall to base



Transporting plywood sheet

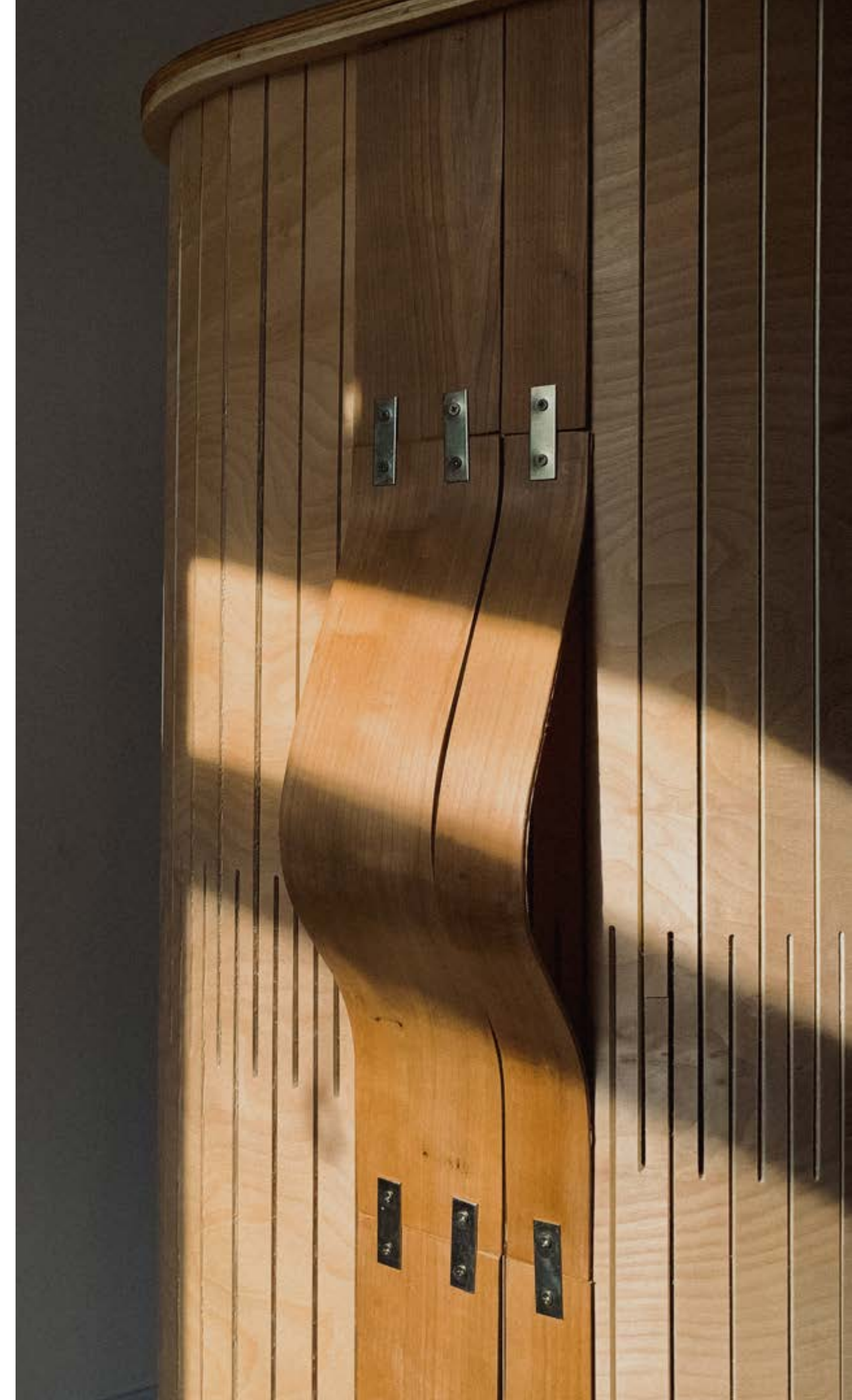

09

2021-2022

**Dissecting Conformity in
Architectural Practice:
RAADio Season 2**

Created by Aahana, Daniela, Dhruva, Hein, Leon, Malavika and Rocio



raadio
raadio
raadio



Aahana: Hi, this is rAADio, a podcast produced by students of the Advanced Architectural Design program in the Graduate School of Architecture, Planning, and Preservation at Columbia University.

Daniela: Welcome to our second season! In the six episodes, we are dissecting conformity in architectural practice.

Dhruva: For us, practice includes designing, writing, teaching, drawing, fabricating, performing...but also, it may include not producing anything, and “just” thinking and learning.

Hein: This is, actually, at the center of this season of raadio: we want to open the conversation about the expectations of architectural practice in academia and the workplace – like being always productive – to show that a non conforming practice has many faces, and can be enacted in many ways. So, what does it mean to practice architecture in a non conforming way?

Leon: We have centered this season around three questions:

Do we need to be sleep deprived to produce good architecture?

Do we really need to accept precariousness to produce good architecture?

And ...Do we need to build at all to be an architect?

Malavika: These are just starting points that connect us to deeper issues that start and finish beyond architecture, but that we think are relevant for contemporary practice.

Rocio: Our best hope is to begin to expose how we play a part in the networks that exploit our bodies, our labor, and our resources in order to fulfill the expectations of an increasingly demanding world. So...join us in this second season of raadio in which we are calling for sleep, resistance and the choice to follow your passion.. in practice.

This is the season opener, episodes releasing shortly

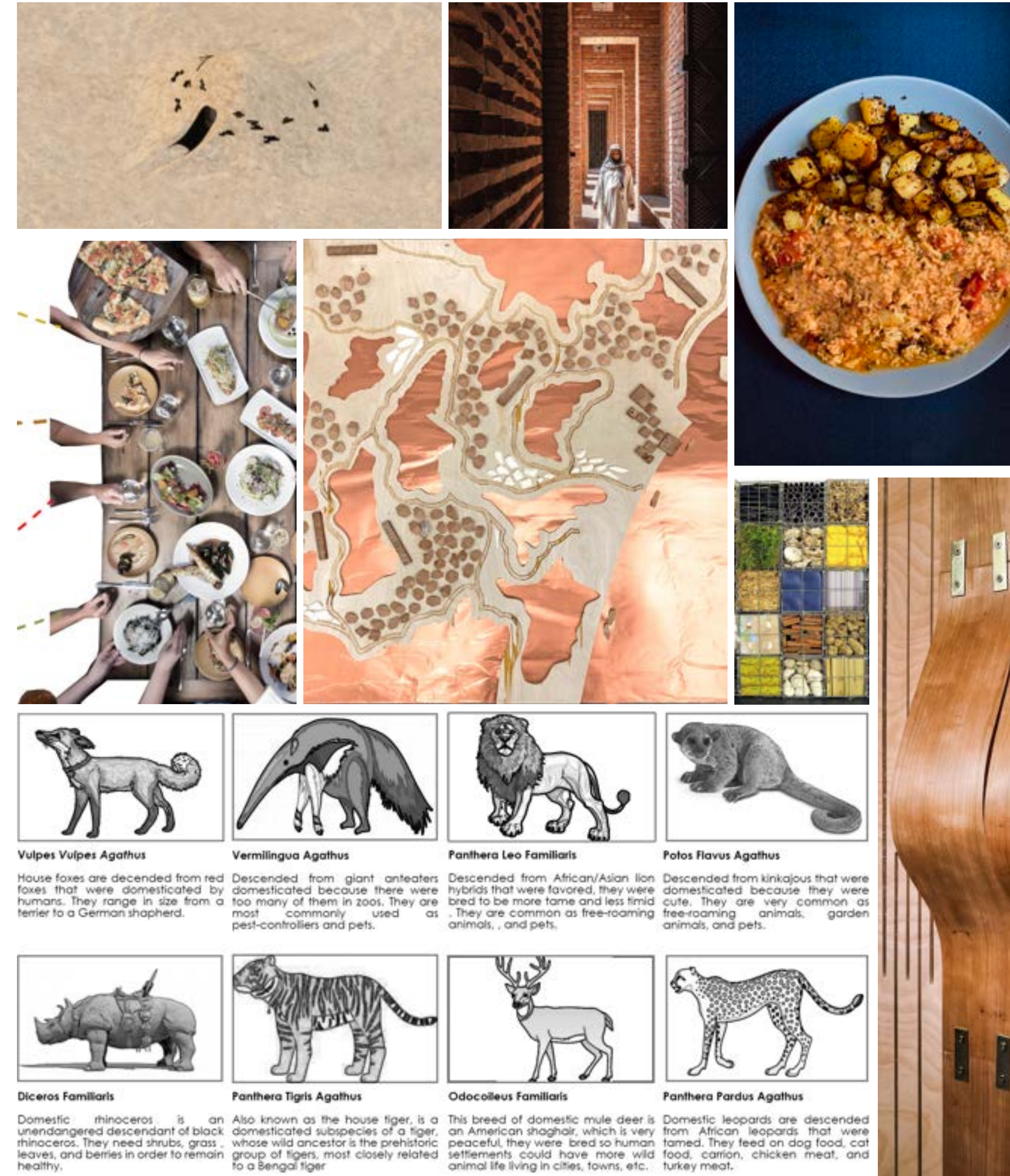

Epilogue

This collection of narratives you just perused through, dear reader, was supposed to be ‘yet another’ portfolio submission. A formality, completing which, 7 years of architecture school would be capped solidly with a Masters Degree. However, to me, it has somehow snowballed into a revelation of immeasurable value. Over the past few weeks, I have spent hours breaking my head over what my stance for this penultimate document should be. Would I find that one precise, minuscule common thread that runs through all my work at GSAPP, perfectly balancing theory and design? Could I not have made life simple by choosing three similar studios that follow the same chain of thought? If I did not find a fitting stance, would I deserve to graduate? Then, a few days ago, by some curious twist of fate, I chanced upon the first few lines of my statement of purpose, the very document that got me here in the first place, which read:

“The question ‘who are you?’ has always caught me unhinged. Born to south Indian parents, raised in post-war Kuwait, I yearned to unravel my identity, constantly seeking some semblance of singularity, until one summer in Istanbul. I stood transfixed before the Hagia Sophia, which had been unabashedly altered through history, becoming different things to different people. Despite its obscured tenure, it stood tall, proudly exhibiting its multiplicity, making me cognize that my identity was not constrained by singularity, but composed of myriad layers, each of which enriched my psyche in a way ‘sameness’ seldom could.”

Reading this, I realized what I have always known: that conformity is just not my color. Sticking to one project theme or one train of thought all year long would not have given me the richness and the texture that I have been bequeathed today. As I assembled these nine chapters together, and reflected upon them carefully, I felt kernels of my values embedded deeply in each of them: In the helpless eyes of the homebound exotic pet. In the phlegm filled coughs of the Cahuilla. In the fragrance of *Amma’s sambar*, and in the sinuous curves *Anaïs’* beholds.

I laughed enigmatically to myself as the haze had finally cleared! It became inherently clear that for this unique tapestry, the common thread I so yearned for none other than me.

I am the weaver, and I am the weaved

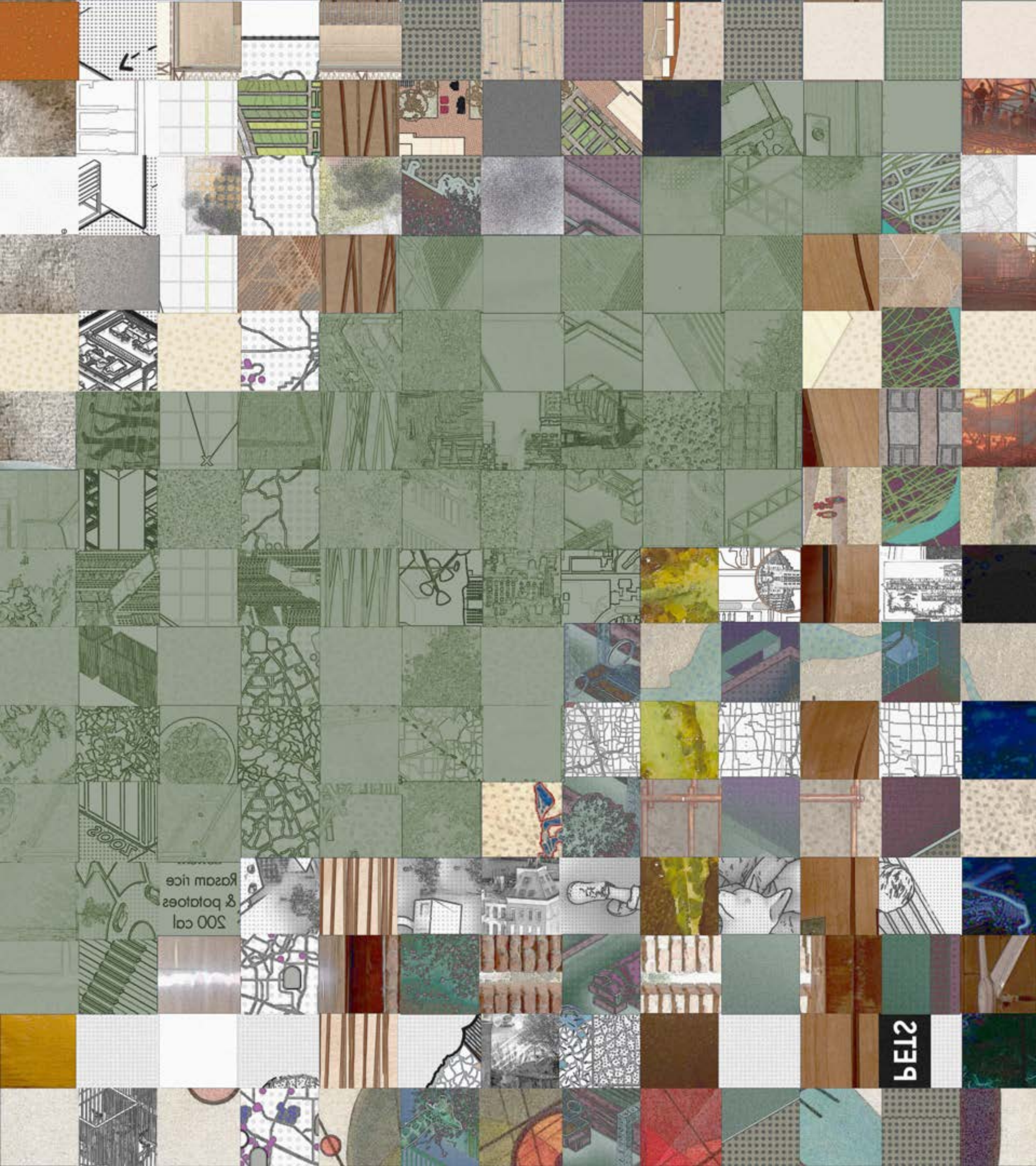

Rasam rice
& potatoes
200 cal

2199