

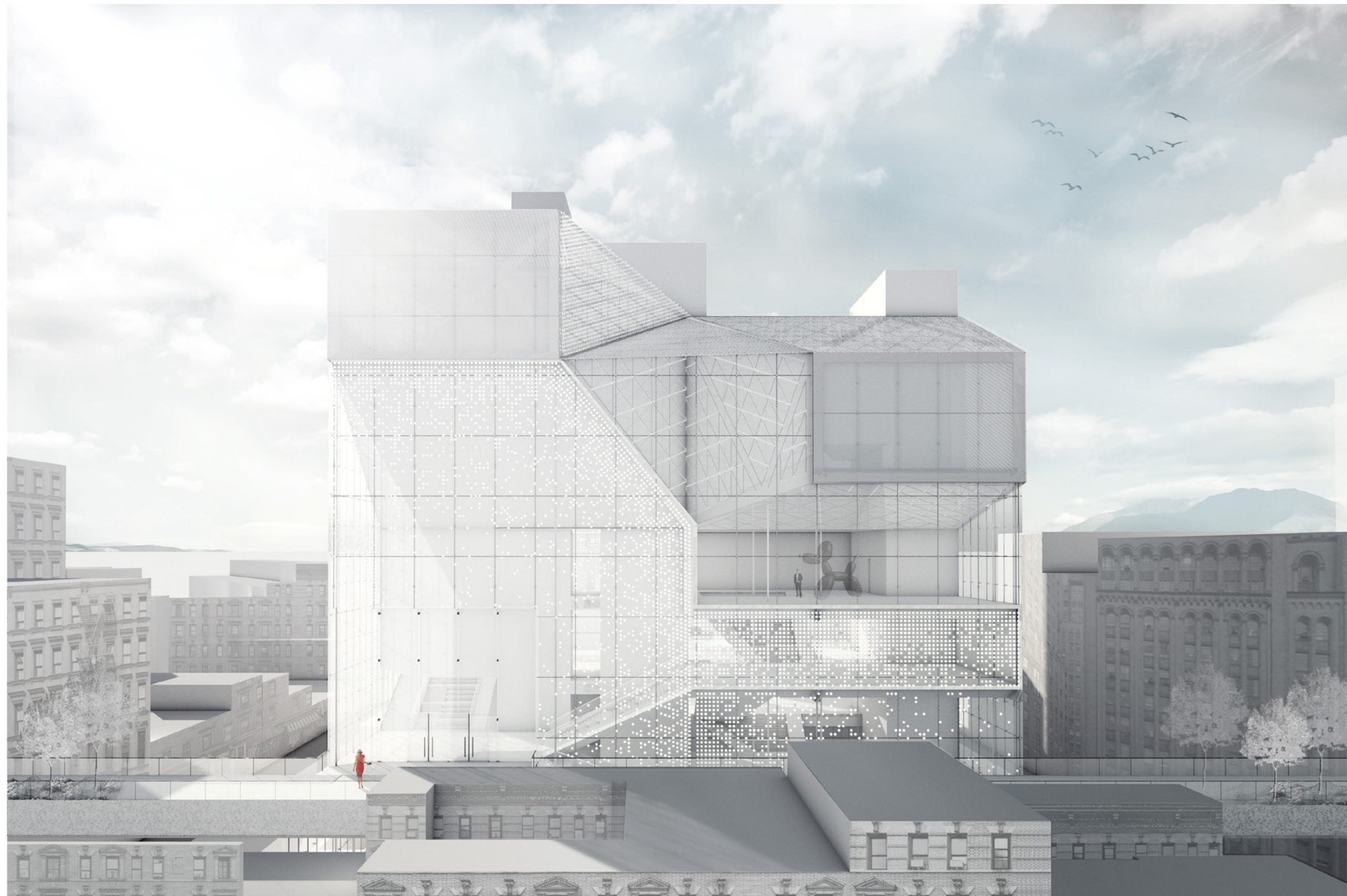

CERAMIC 3D PRINTING STOOL
Spring 2018 | Directed by Rhett Russo

MENGZHE ZHANG

ARCHITECTURE PORFOLIO



01

WEST CHELSEA CULTURAL CENTER

Team partner | Yiqi Song
RPI Design Development Studio | Spring 2017
Instructor | Lonn Combs, Gaby Brainard
Site | West Chelsea, NYC
Individual Effort | Scheme design, Construction design, Model making, Diagram making

This IDD studio is combined with the IDS studio which I basically designed an overall scheme which continued to be developed in spring 2017. The site is in Chelsea NYC and this project is designed as a cultural center.

Chelsea, as being a historical and artistic city, has many piers, subways, and parks which spread all over the area. These kinds of places give a birth of a bunch of events. Considering the site is in the center among these places, the idea is to make a new hotpot event center in West Chelsea which corresponds to the prosperous atmosphere. In order to create a grand civic space for holding multiple events, INDIGENOUS, ICONIC and PIVOTAL are three important factors which are mainly presented in the project.

Providing great spaces for events area requires the building to have a certain amount of outdoor terraces and public indoor spaces. Piercing an irregular geometry into a cube helps to create identical shape and also provides various possibilities for different types of programs. The circulation is designed as multivariable and flexible especially on the ground floor which is regarded as a vital transportation center among the site area. As the structure of the building is a bright spot, the exposed structure parts will be a unique language of this project when people browse among these large public spaces and have an extraordinary experience.

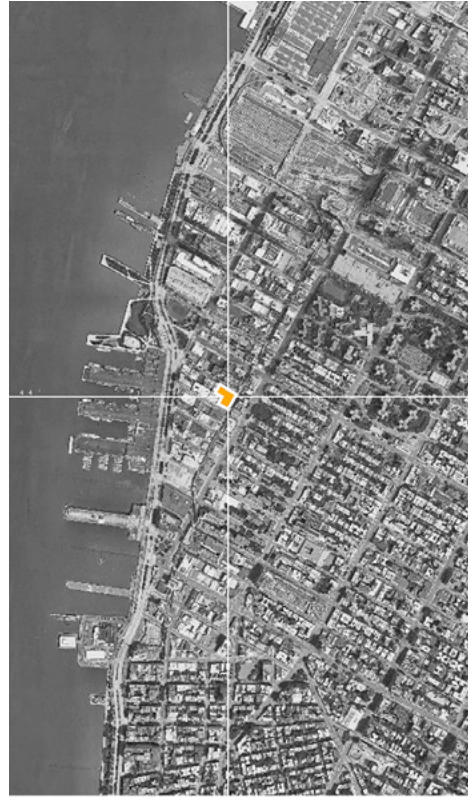

WEST CHELSEA, NY, NY



PIER 62 AREA OF WEST CHELSEA



PARK CENTER OF WEST CHELSEA

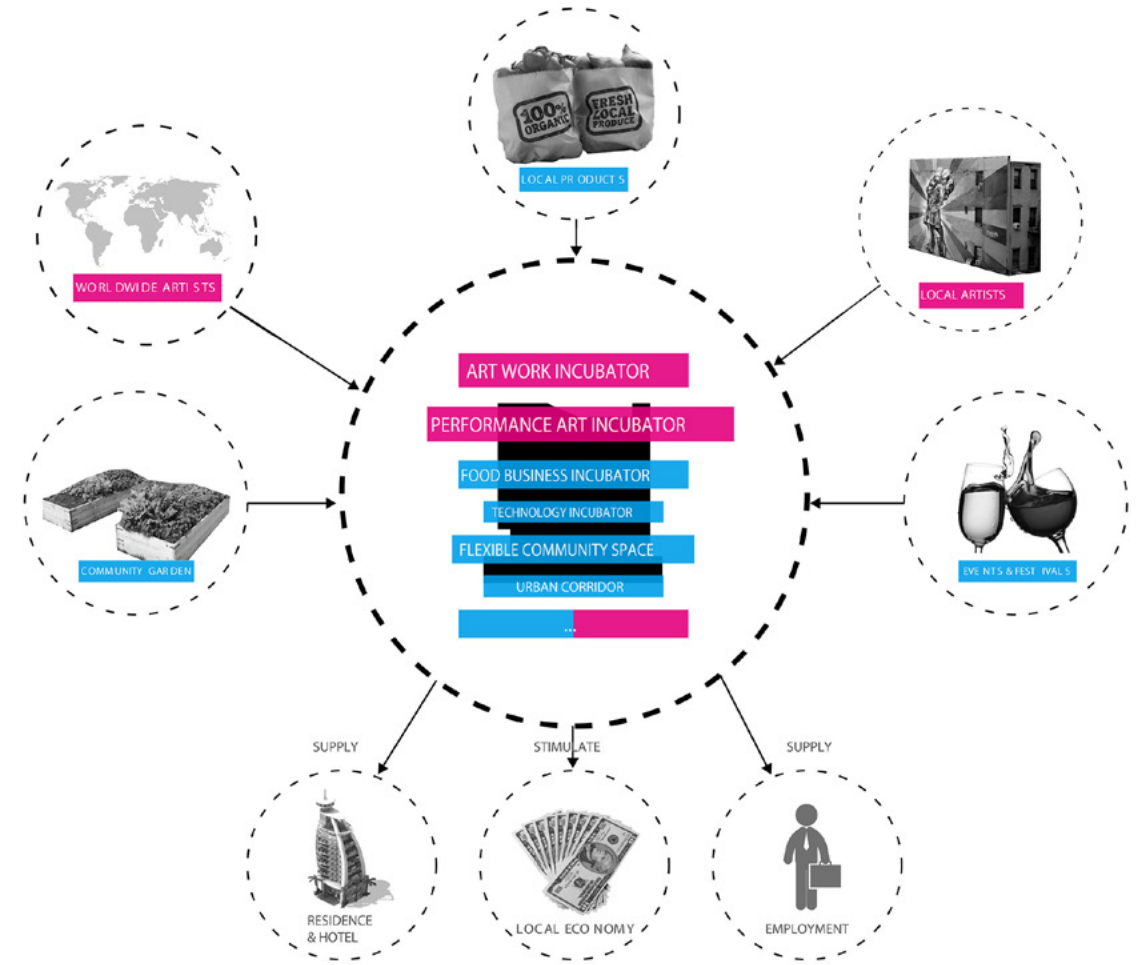

ACTIVITIES

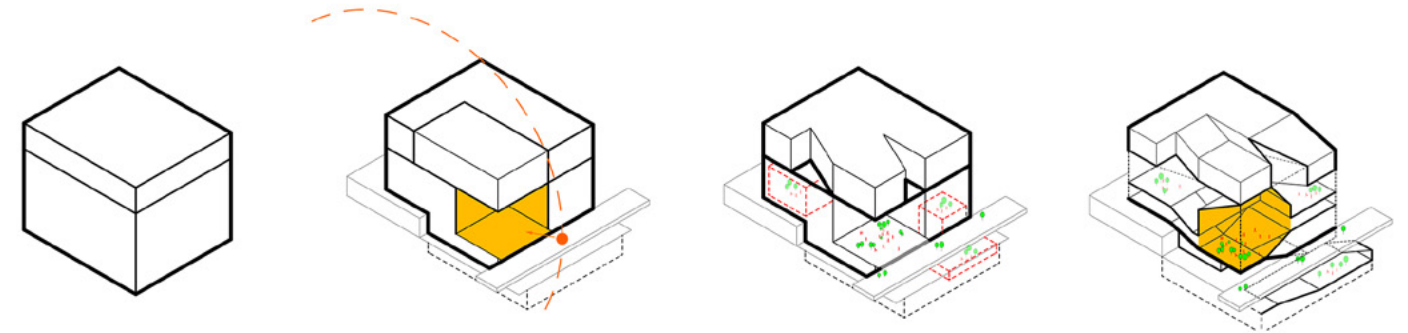

CREATE A NEW HOT SPOT IN CHELSEA

Chelsea as being a place where full of cultural events and artistic activities, has hot spots which exist everywhere among the city are super attractive not only for the native but also for outsiders. Start analyzing the hot spots' location, we tried to bring them connected to our site and recreate a new grand civic space for public.

This project covers two semesters' effort: begin with the first one: Integrated Design Studio which I mostly focus on massing and concept development. Then my project was taken to the second studio which is Integrated Design Development Studio. In that semester, I teamed up with one of my classmates and deeply

any continue to develop this project deeper to achieve DD level. The design approach is largely related with the highline which just near the site. By bringing the role of highline into the project, the building starts to have a direct connection with the city physically and also a conceptual relationship with the social events. The massing is designed in a way opening more to the highline side and continue the language up to the top of the building. The folding-like building language is another character which introduces the building in some certain sense that it is an iconic signature of that area but also a "landscape" form which cannot live without the highline and surrounding environment.



TWO MAIN PROGRAMS



TWO STRUCTURAL SYSTEMS

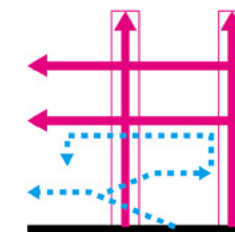

TWO CIRCULATION SYSTEMS



TWO MATERIALS

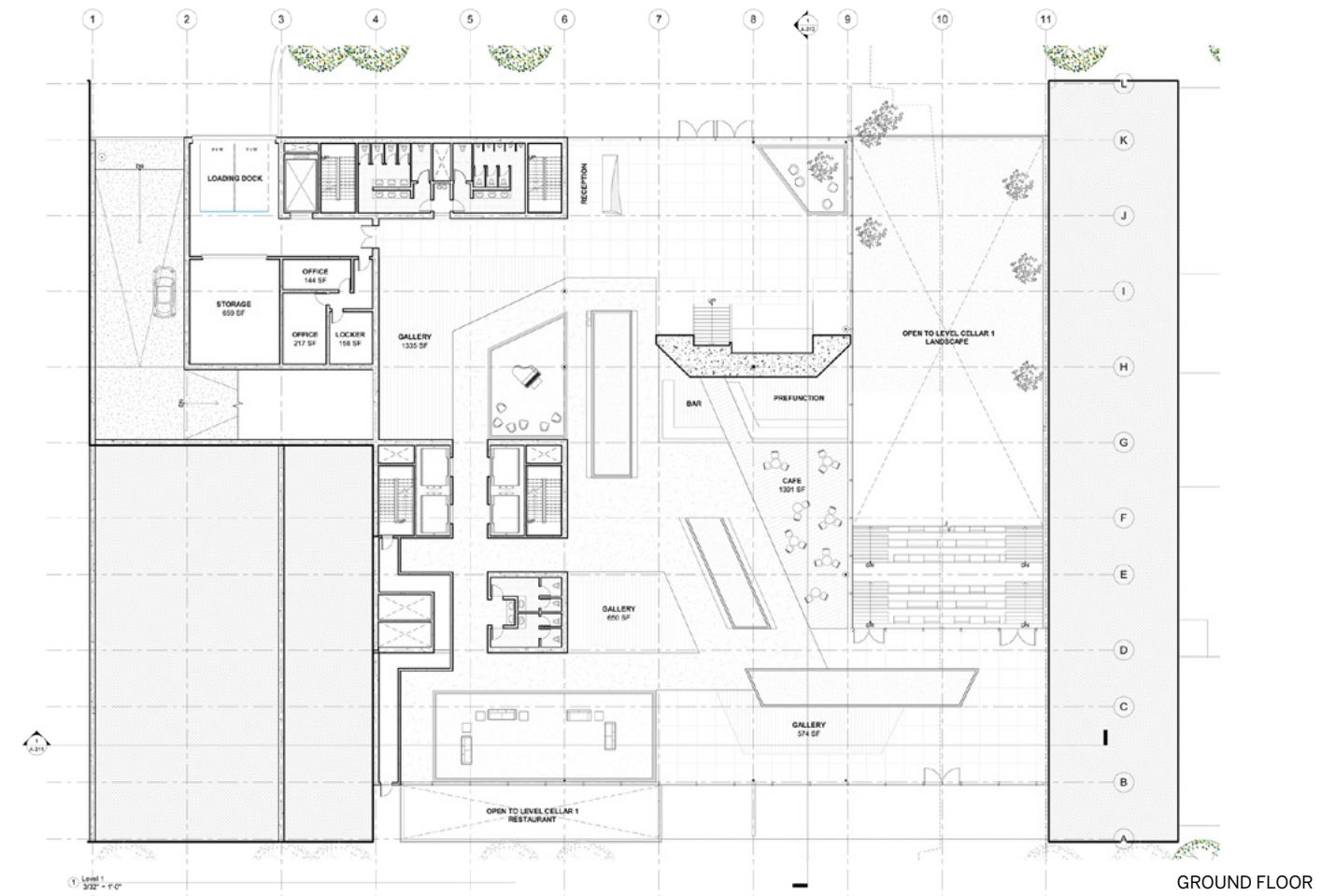
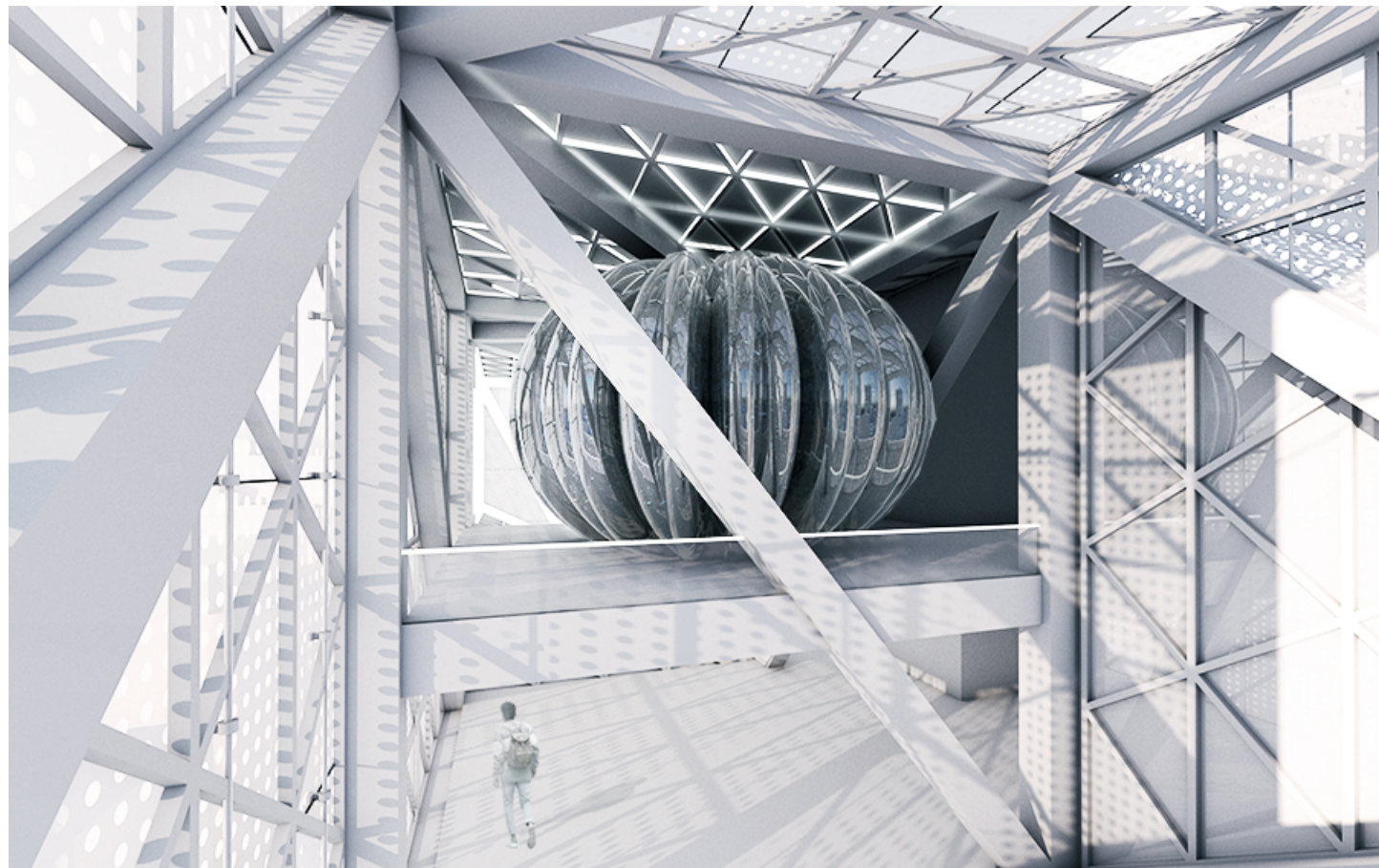
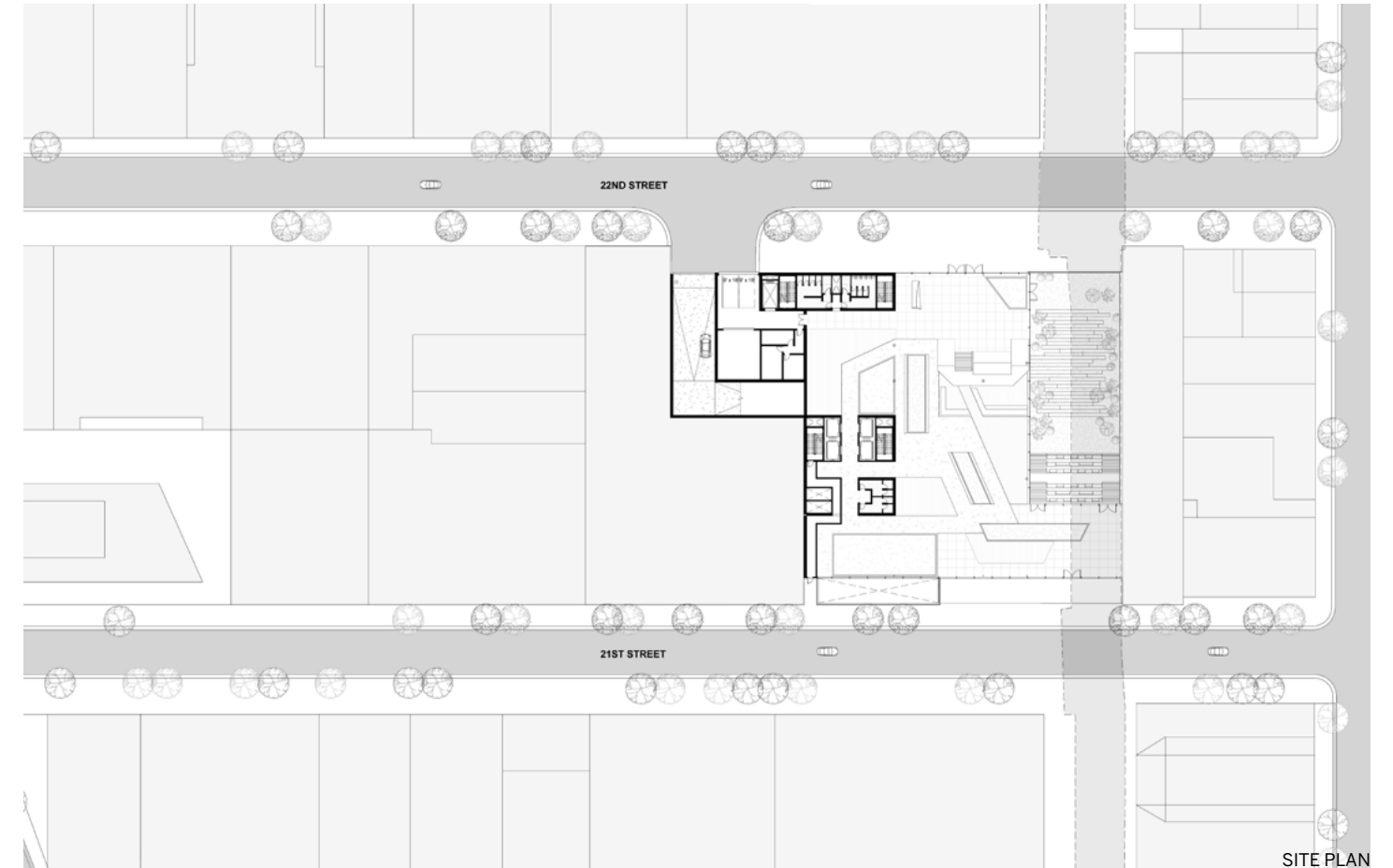
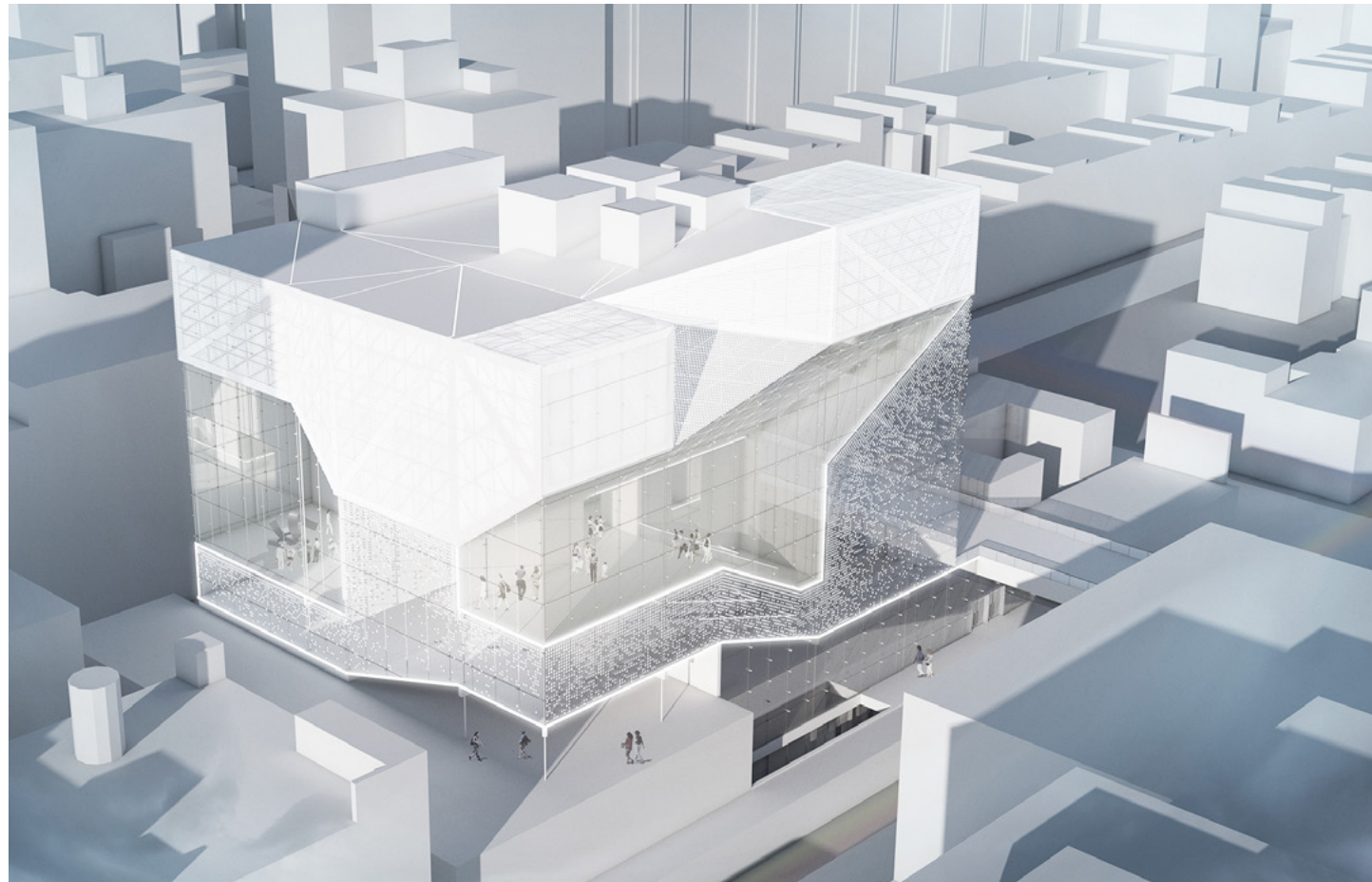

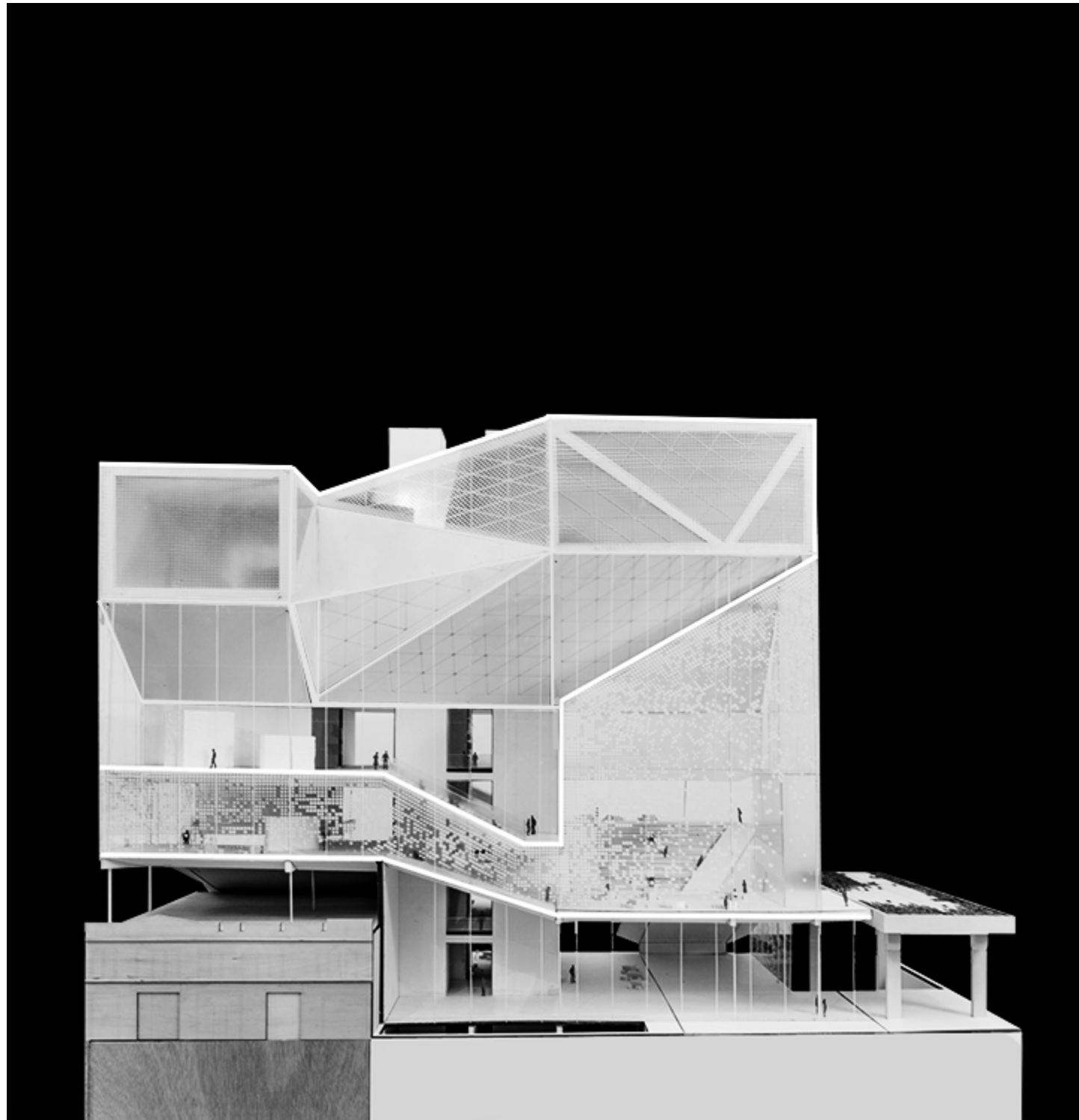

FOLDING LANGUAGE

The folding language appears mainly around the elevations of the building which grows from floor to the wall. Why using this strategy which seems like much costly than the normal one? The idea is to describe the top theater as the main core of the building which is like a huge cloud floating in the sky. The rest of the parts which beneath the theater become public and highly flexible space. The connection between the rigid one and the lower floor plates can have a coherent representation when using the folding strategy. The building in this way is like an onion whose skin peels off from top to the bottom.

The bottom and the skin which falls down separates into walls and floors. So that although the massing is originally formed from the combination of a regular object and irregular one, the way they combined helps them become a unity.

Furthermore, the imagination of the building is not only as a rigid, conventional project, but brings me much more flexible and fluid conceptual idea of this culture center: seeing it as a pure white giant object sitting in the most flourishing district in the city.

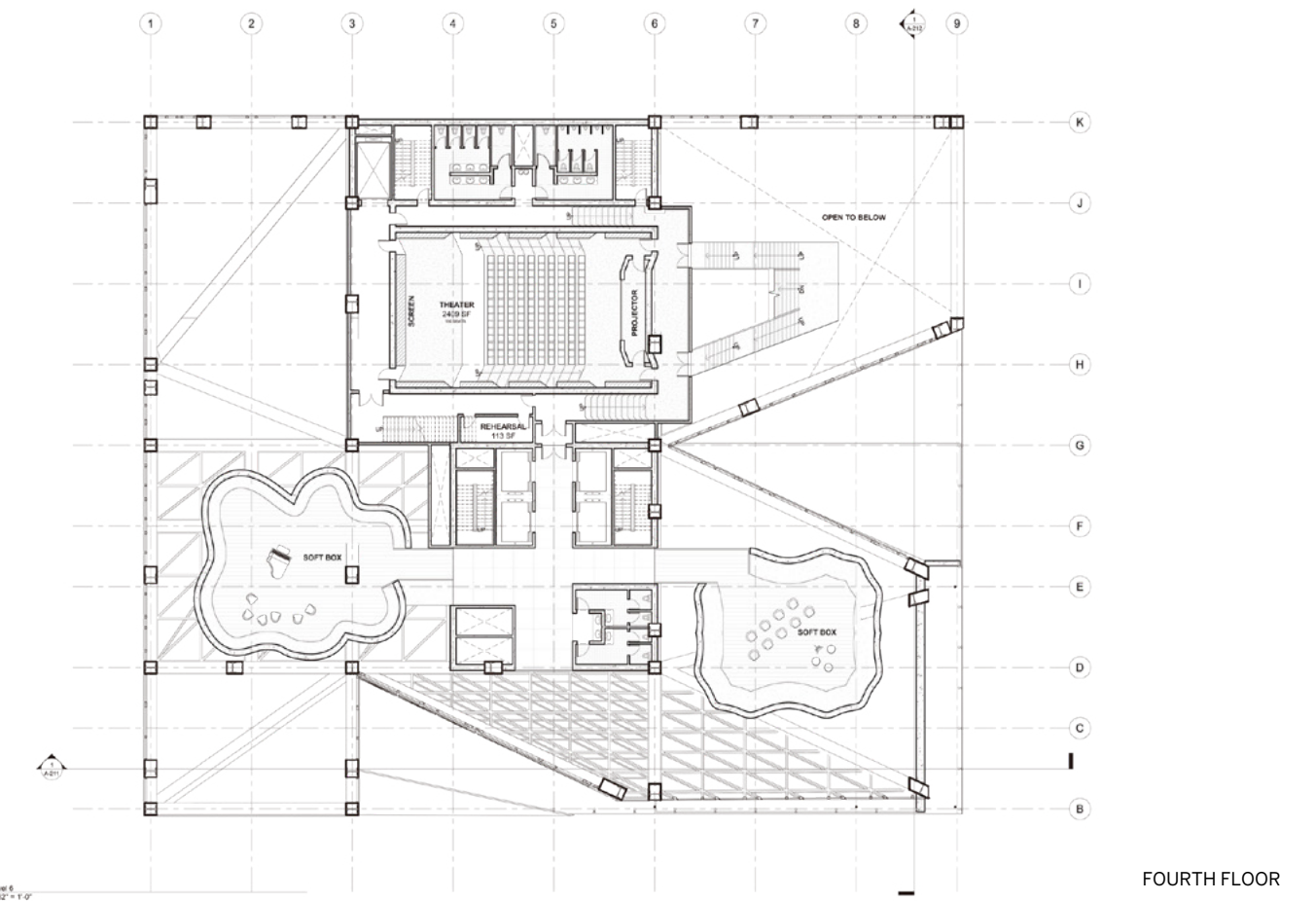
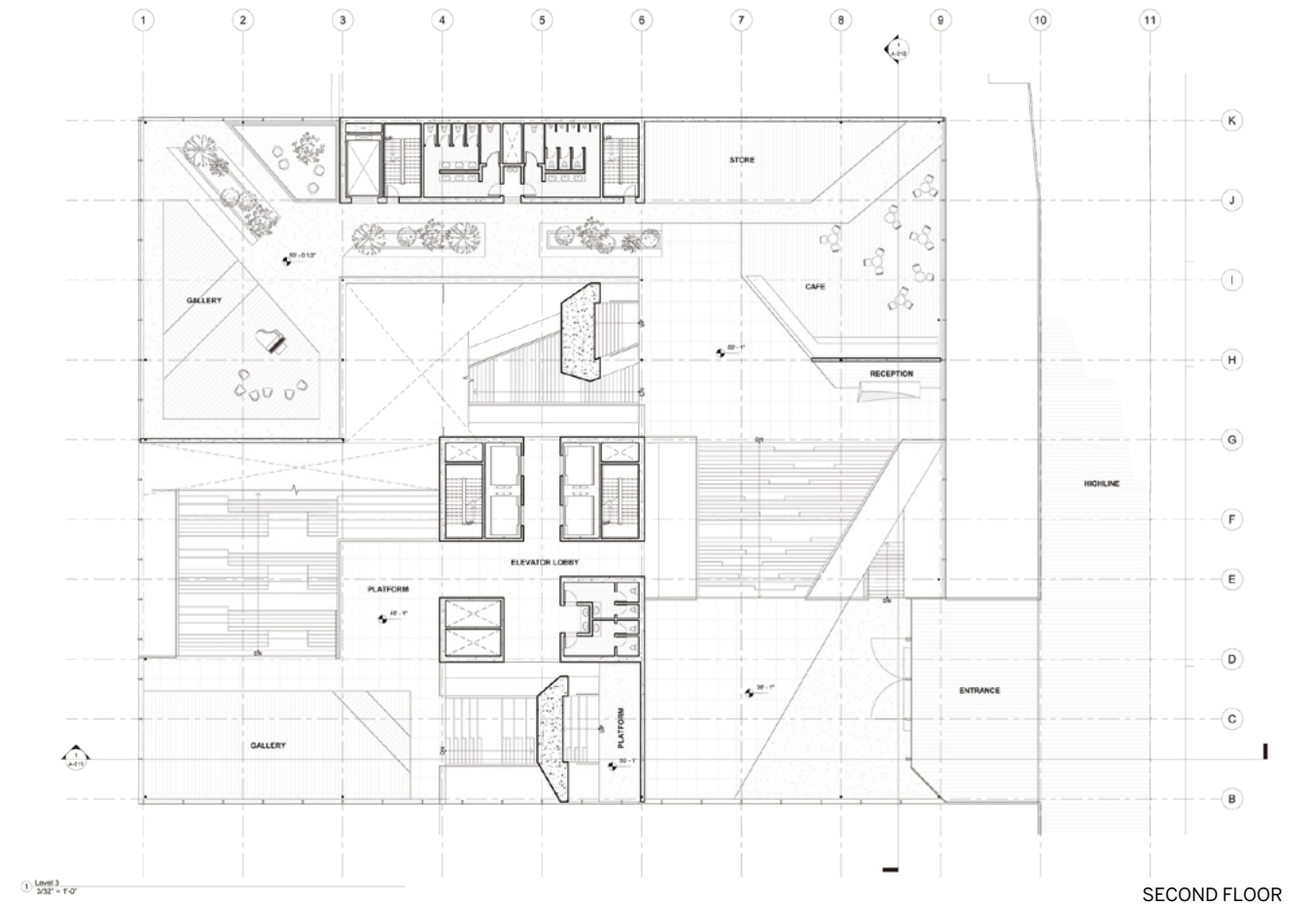

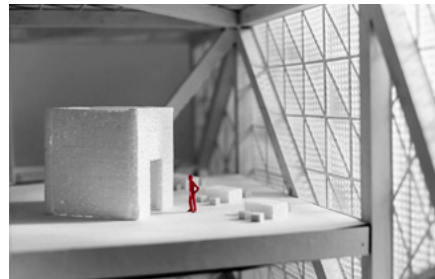
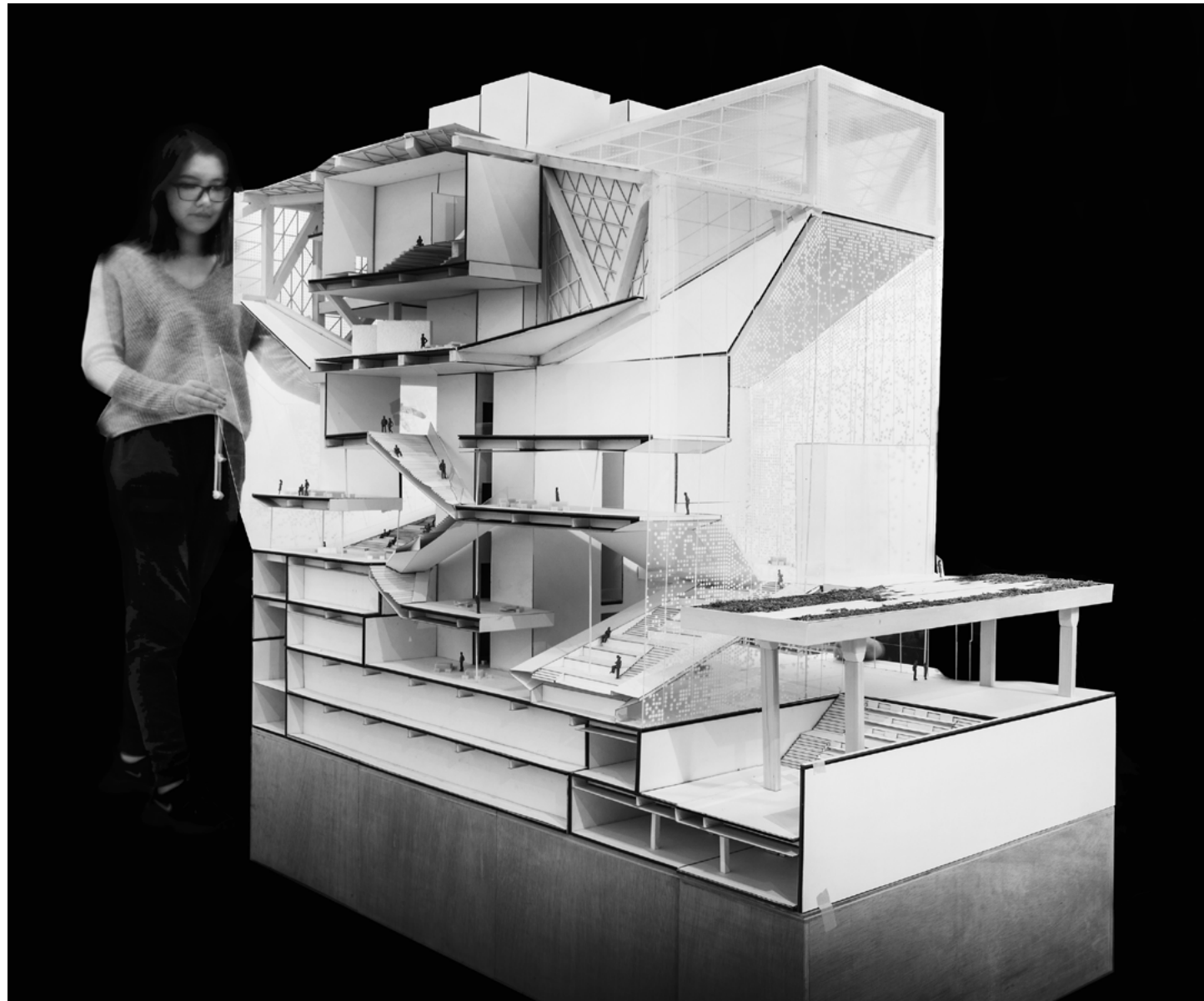

1' = 4" MODEL

A big section model is built in the scale of 1' = 4" to show better space condition inside the building and also be a practice of model making. The model is up to 5.5' which close to a human height and took about one and a half weeks to build.

Model is not only a simple representation of the digital model but actually a new process to rethink the scheme. Especially through the construction process, which most school project always ignore the importance of the structural components but for this studio,

the construction part plays a vital part. The importance of the two cores is very obvious which they are built at first. The truss system helps the upper theatre volume stable and strong. How the cores support the truss system is also designed by adding more connection when they meet each other. The rest of the floor plates can be added on and the outside facade is assembled at the end. Model making is not only making something that appeals exactly the same as it appears on the computer but is a testing process of the structure we design works or not.

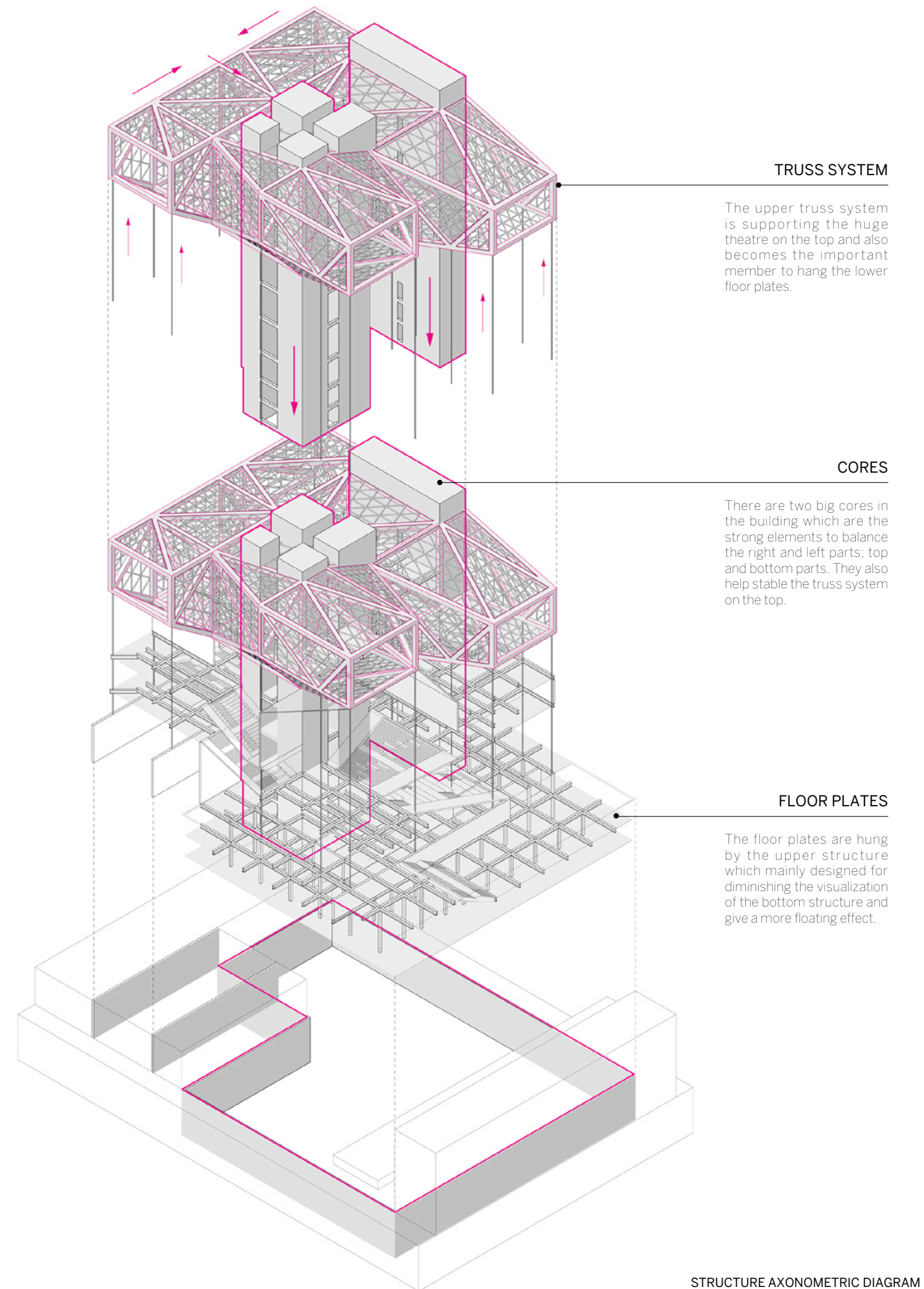

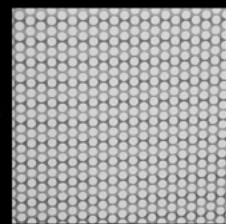
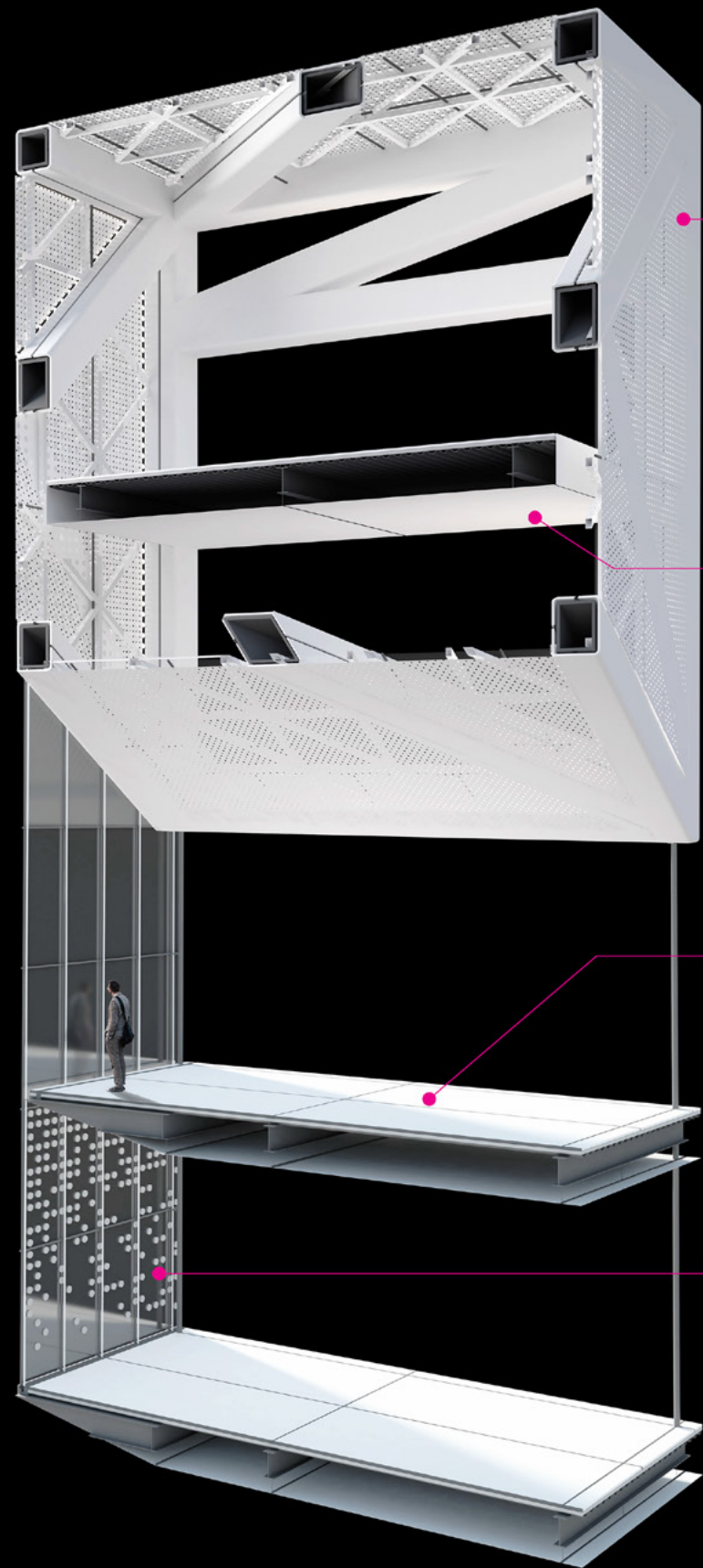

CERAMIC FRITTED GLASS

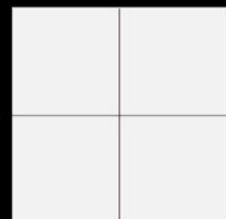

WHITE ALUMINUM PANEL



WHITE CONCRETE PANEL



GRADIENT CERAMIC FRITTED GLASS

FACADE DETAIL

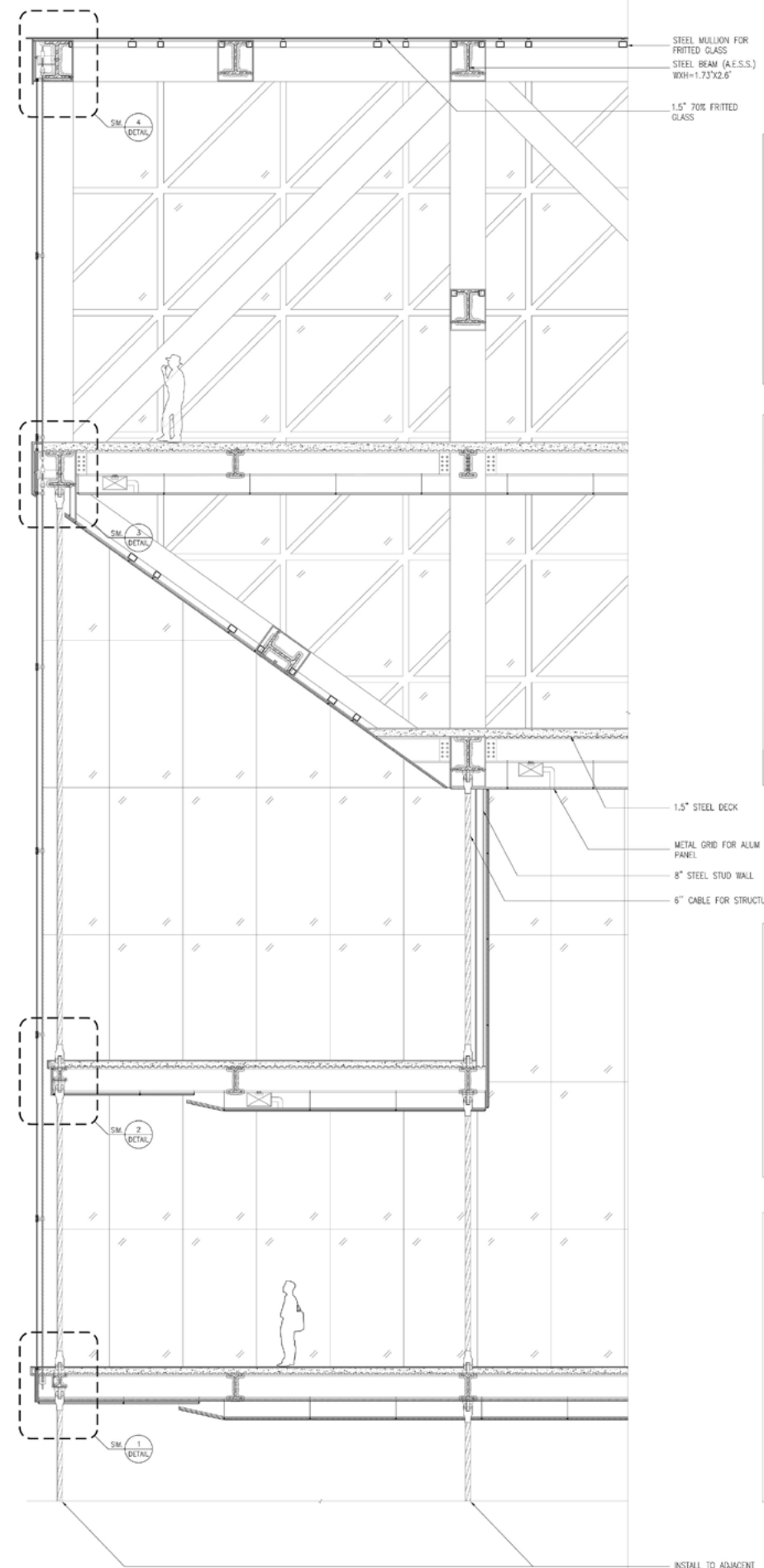

WALL SECTION

ANTI-432 PARK AVE

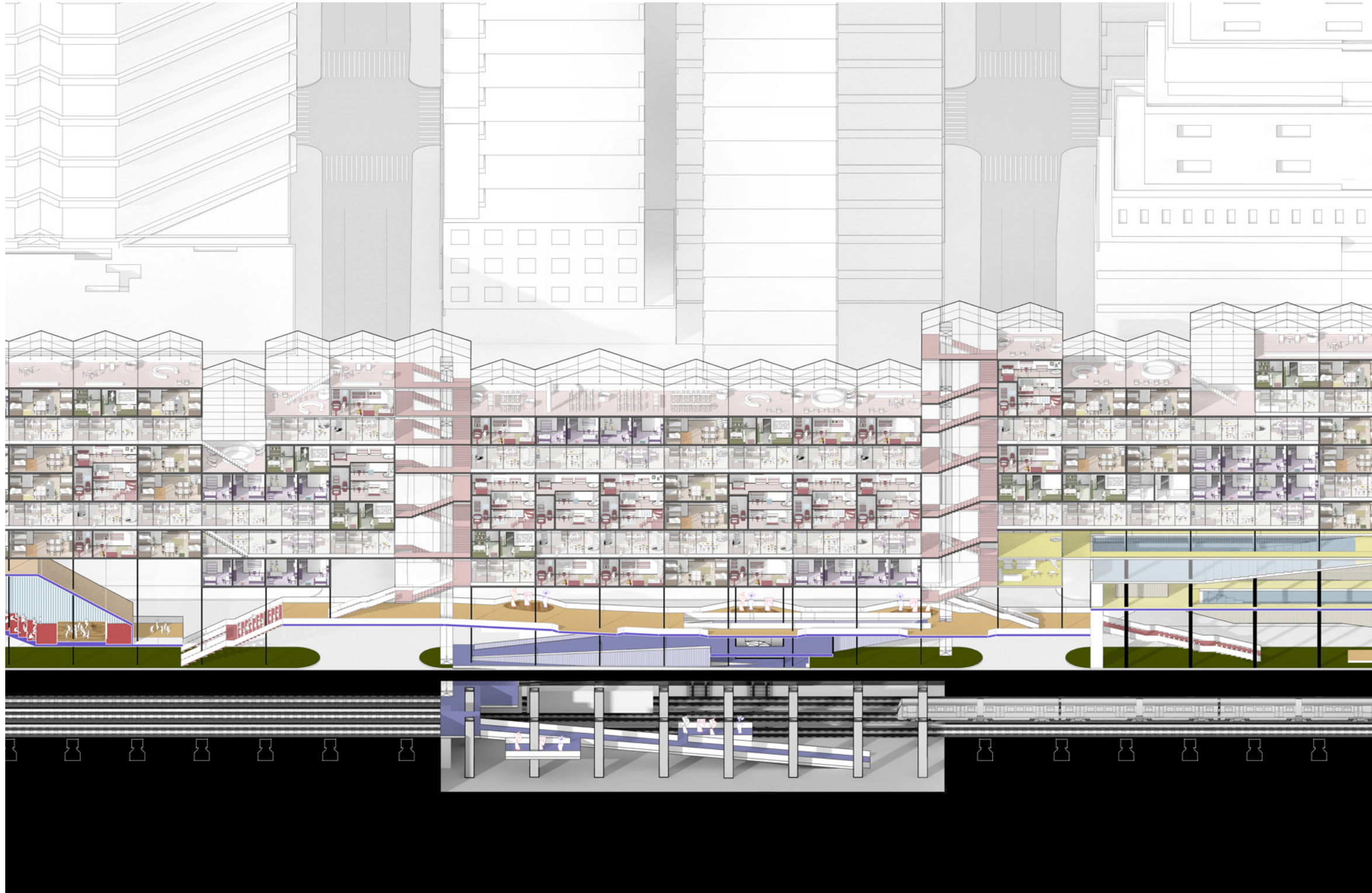

Team partner | Lu Xu
 GSAPP Studio | Summer 2019
 Instructor | Nahyun Huang, David Moon
 Site | Park Ave, NYC
 Individual Effort | Scheme design, Construction design, Model making, Diagram making

This project focuses on developing an inverse version of 432 Park Ave which has been largely criticked for its luxury price and low occupation. Taking Park Avenue from 51st to 56th St as the site, we "flipped" the pencil tower in 90 degrees and lay down it in the middle of the road which used to be open-cut space for steam engine trains, now replaced with green infrastructure. The horizontal long-distance crossing 5 blocks express our idea about establishing a more open project to the public. We also took the same programs from the pencil tower placing them at the ground level of our building to express "everyone is welcomed to entering this building". The upper part is the residential area which all the units will share the kitchen space and four types of these shared units help adapt to different sizes of the people group and lower-income group.

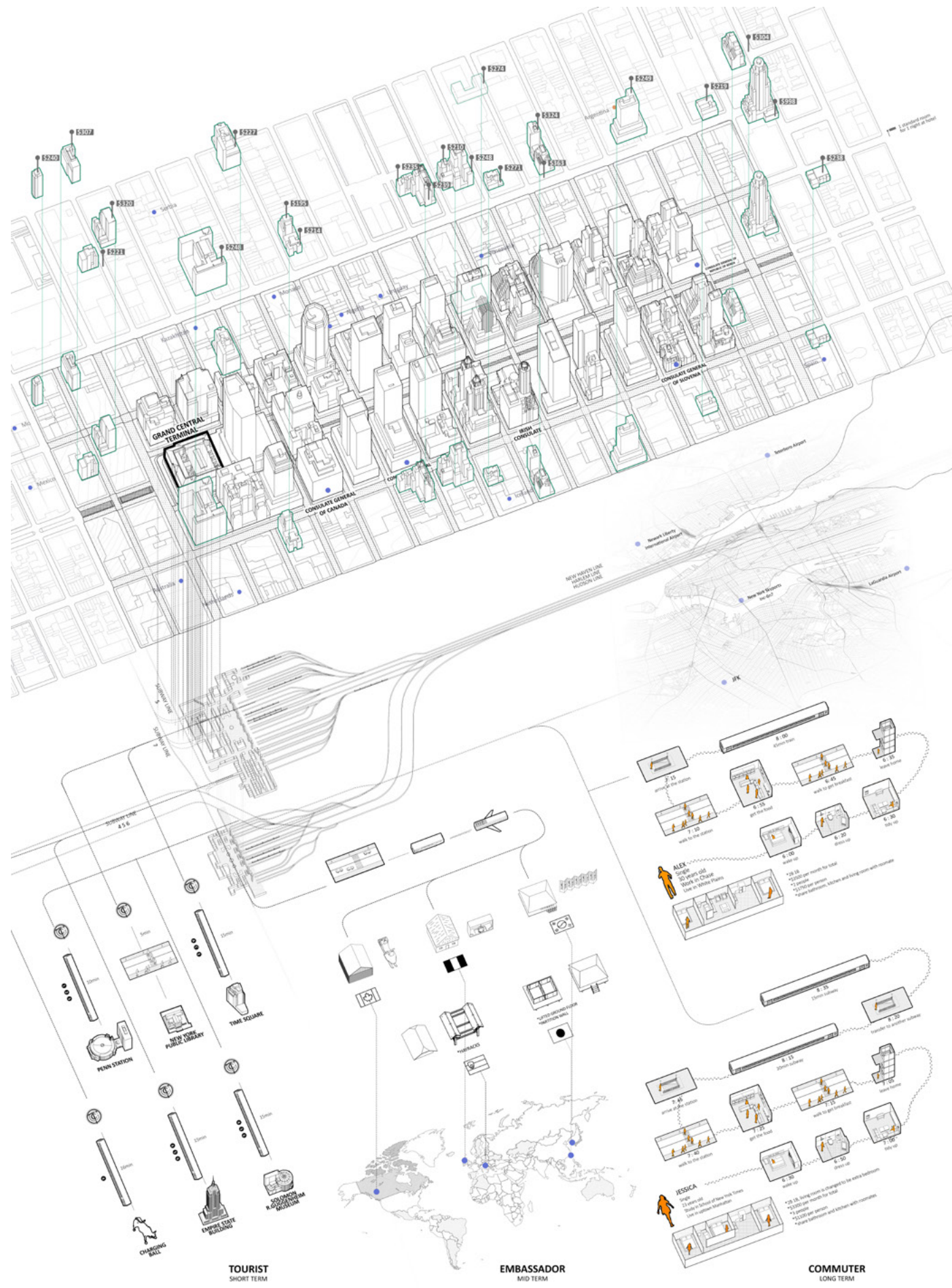

RESEARCH DIAGRAM

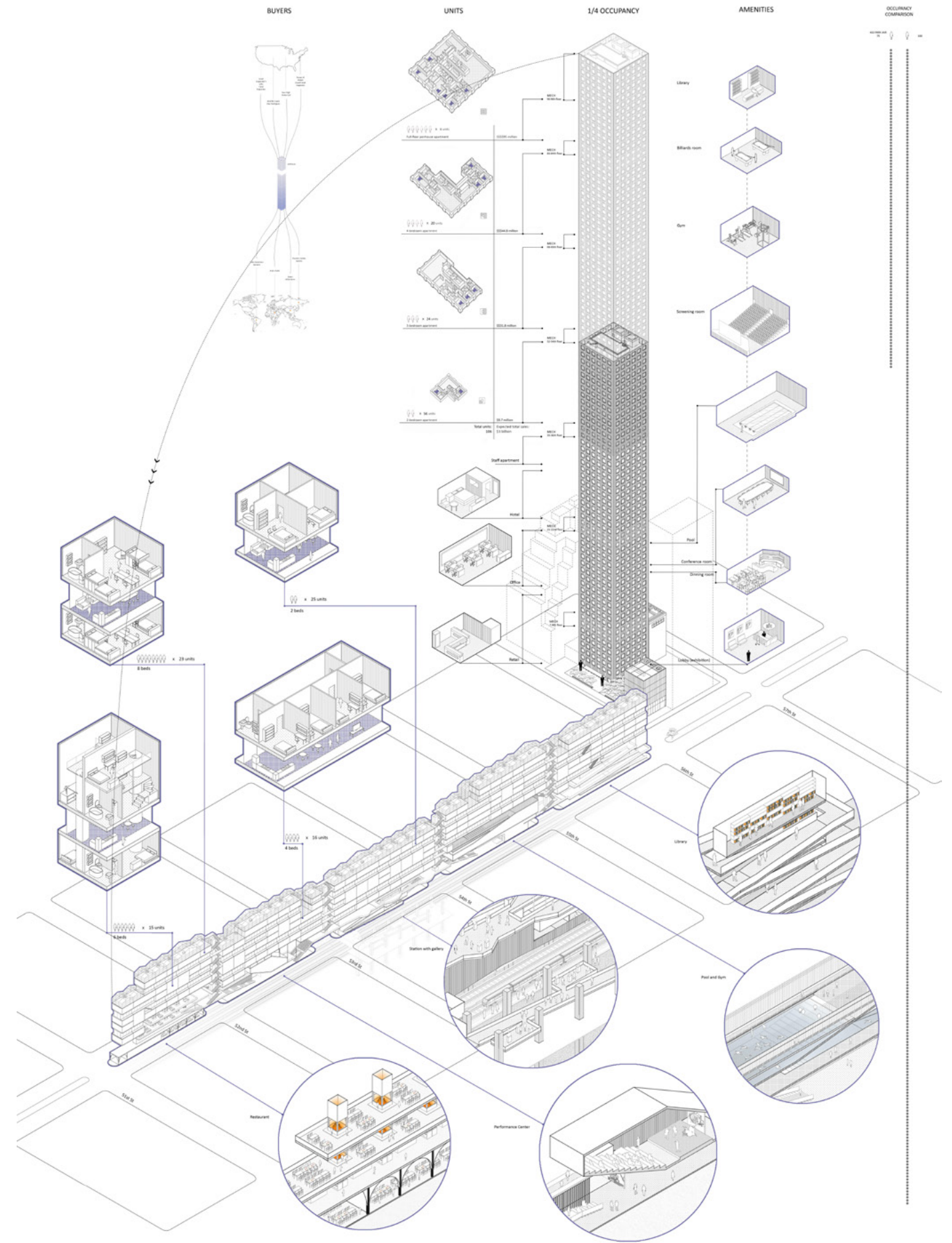

THESIS DIAGRAM

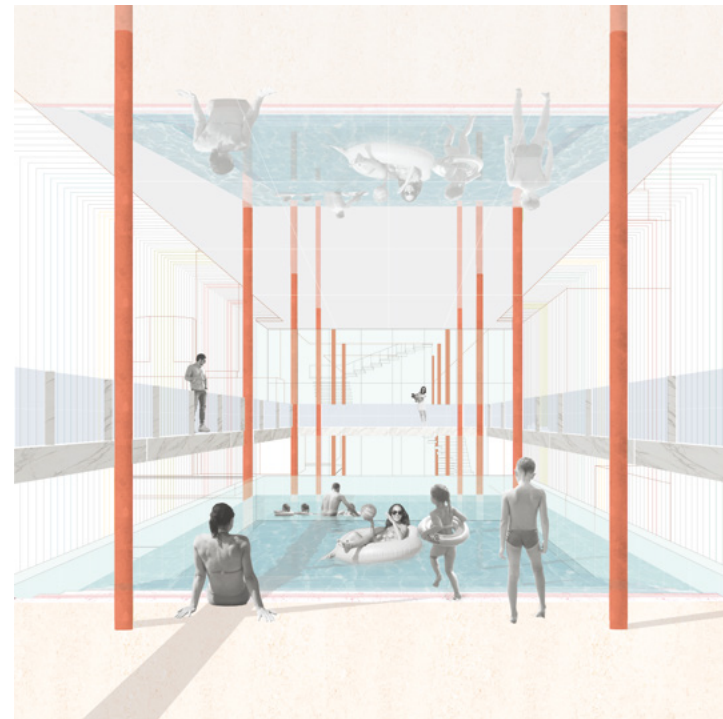
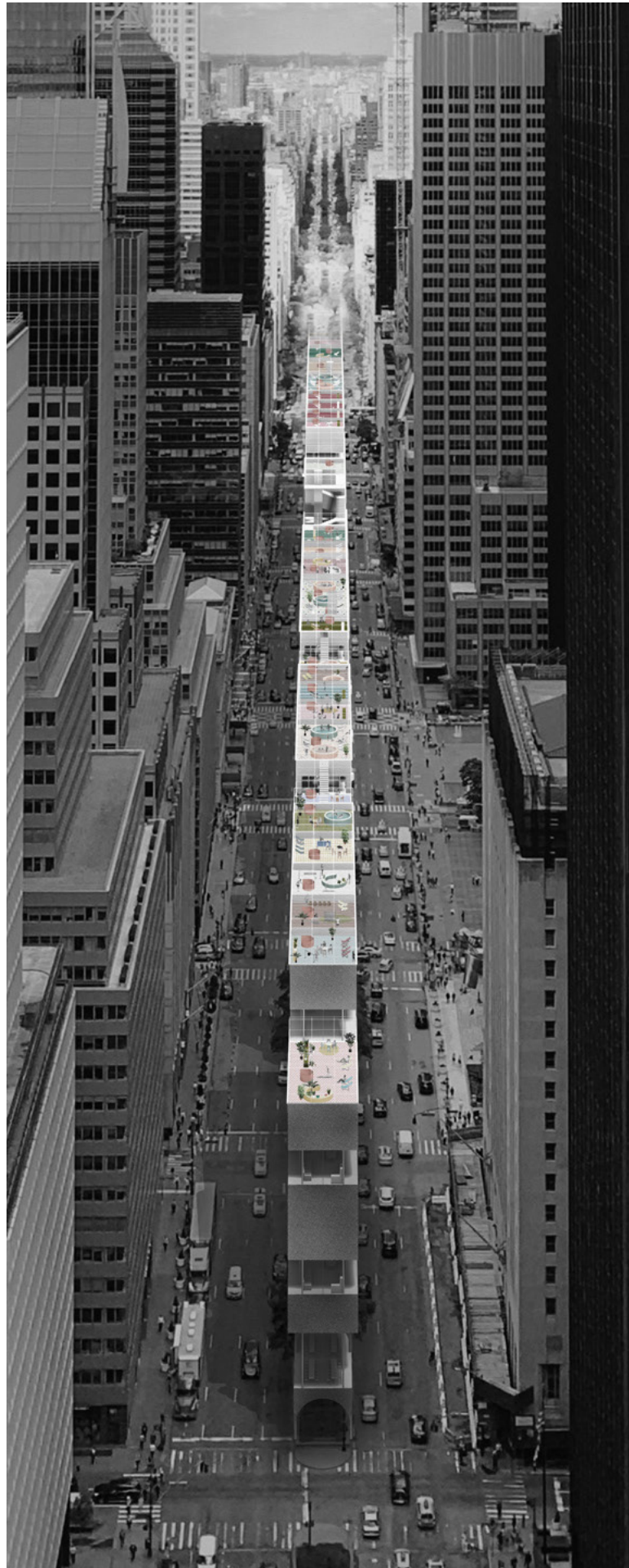

GRAND CENTRAL TERMINAL

As the site is quite close to the Grand Central Terminal at 42nd St, another important idea is to connect the building with Grand Central subway station. Starting from the 51st St to the north, the public programs at the ground floor are a restaurant which is more like an open kitchen: neighborhoods can bring their food to cook there or the communities will provide low price but delicious food for them. The second one is a big concert hall which is different from the luxury Broadway concert hall: it provides a stage for independent artists and film-maker. The middle block is occupied by the subway station which

& NARROW LIVING SPACE

used to be a discarded station, but we decided to reuse it as being a new stop supporting the public transportation and also set up a few small galleries at the sides, which helps independent artists present their artwork without spending a high exhibition fee. The fourth one is a swimming pool which is surrounded by the glass wall so that when people are swimming, they can also see the street view and gyms which contains various work out activities. The last one is a public library in which the bookshelf is in the middle of the surrounding slope platforms. People can walk up and down, and may also relax or have a seat on these platforms. All these public programs not only at the ground level, but the upper levels all contain exciting activity space. Although the building is in a long and narrow shape, it does not influence the normal life and the beautiful story happening in this anti-432 building.

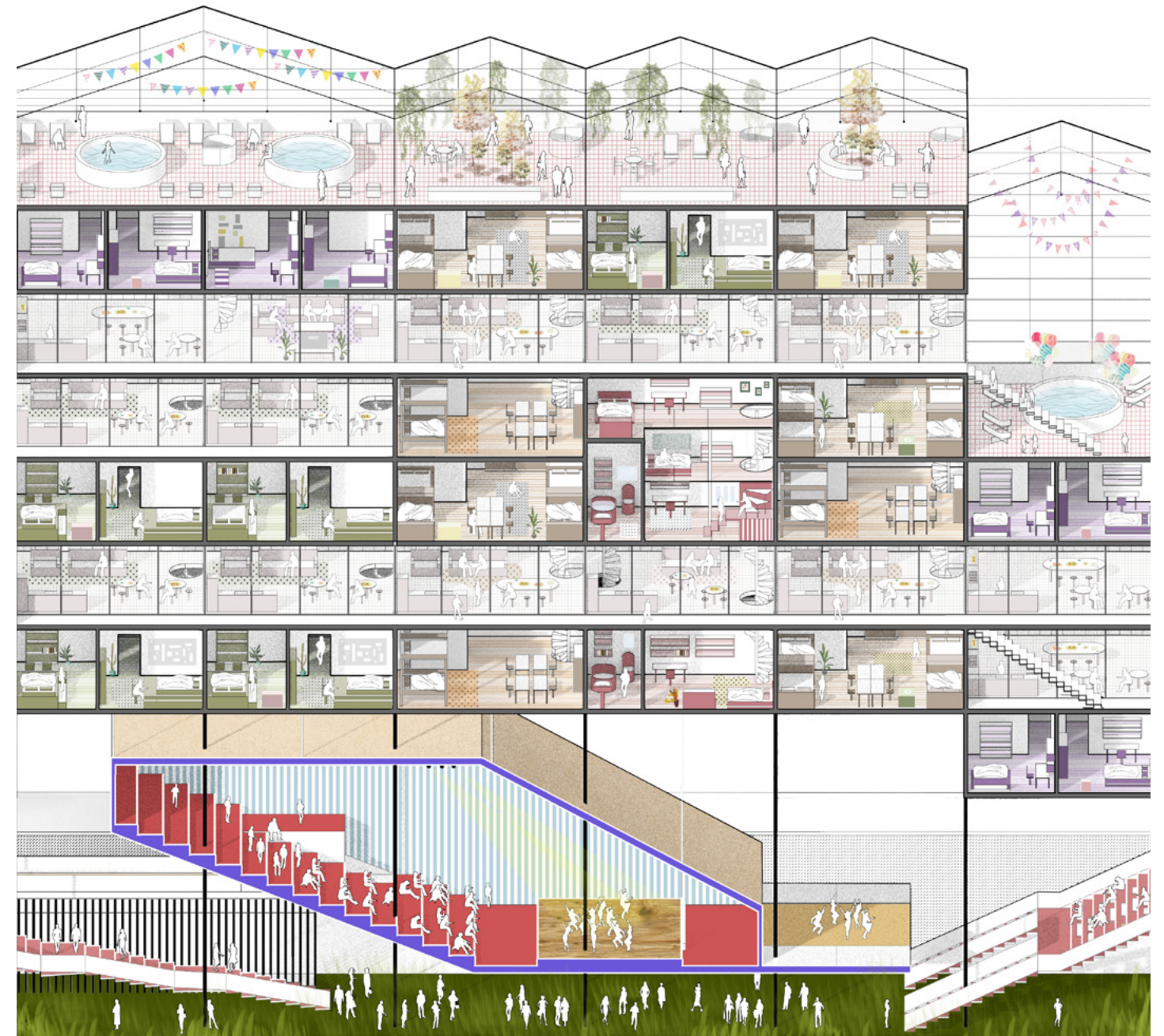
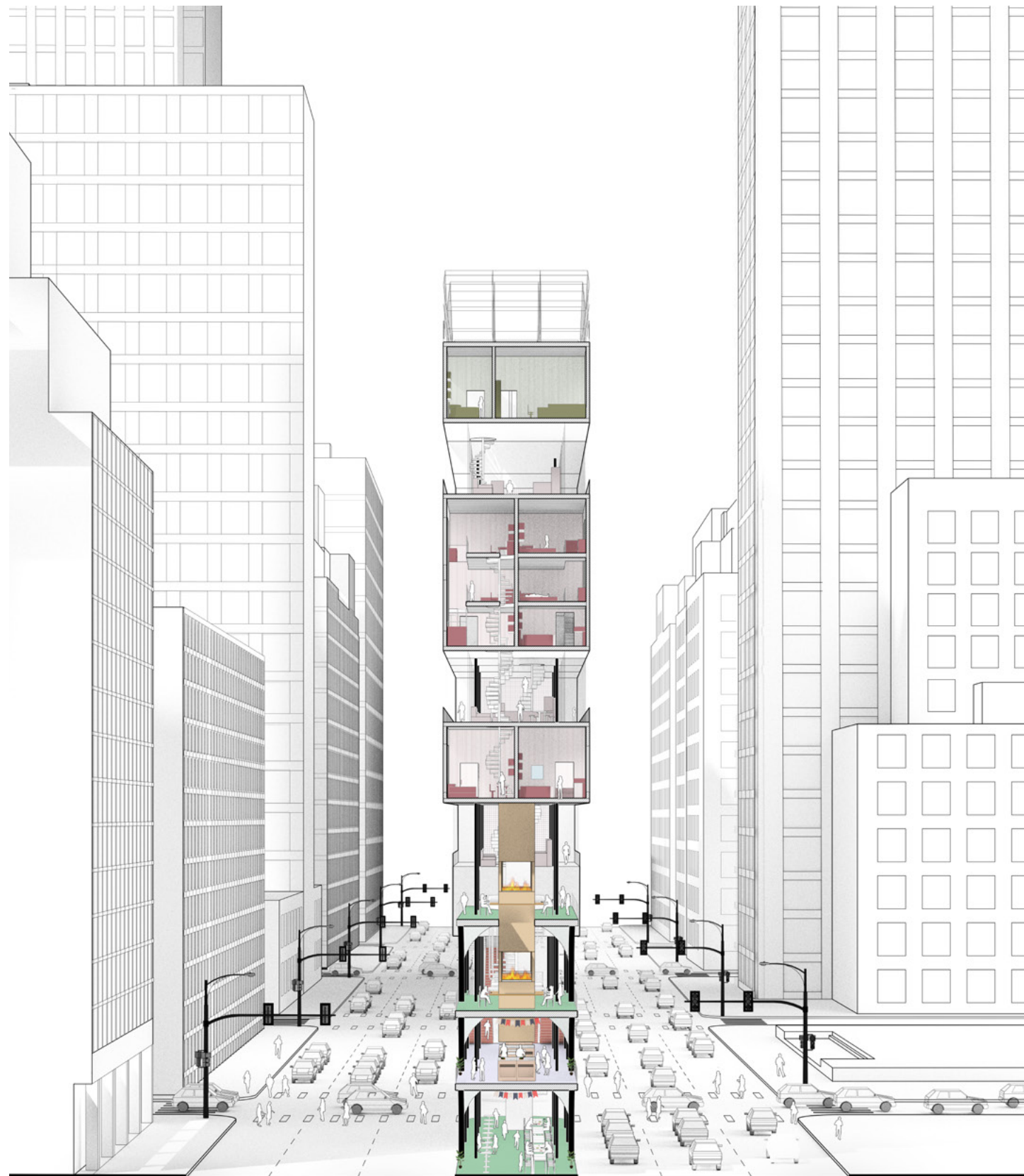

GRAND CENTRAL TERMINAL & PEOPLE

As Grand Central Terminal being an important role in this project, we start researching what it brings to the site. This district used to be a residency area when Grand Central finally established after a few times' design adjustments. However, time goes by, nowadays, although there are many hotels seat around it, this district becomes a commercial center which causes the people to work here have to choose far away from living areas and spend a lot of time on the traffic. Except for the offices, there are up to 10 embassies on Park Ave from 51st St to 56th St. For this type of special officers, they may need a temporary living space since they may need to go back to their country at certain frequencies. This is why we come up with the idea of building a new residency that can provide affordable houses for this group.

Furthermore, Grand Central also brings a lot of people from a different country as it is a terminal for many subway lines, not a simple station. The visitors from all over the world gather around here since it is not only a center of traffic hotspot but there are also many tourist spots and historic sites around it. Combining all these data we found, it would be great to set up a high-density residential building.



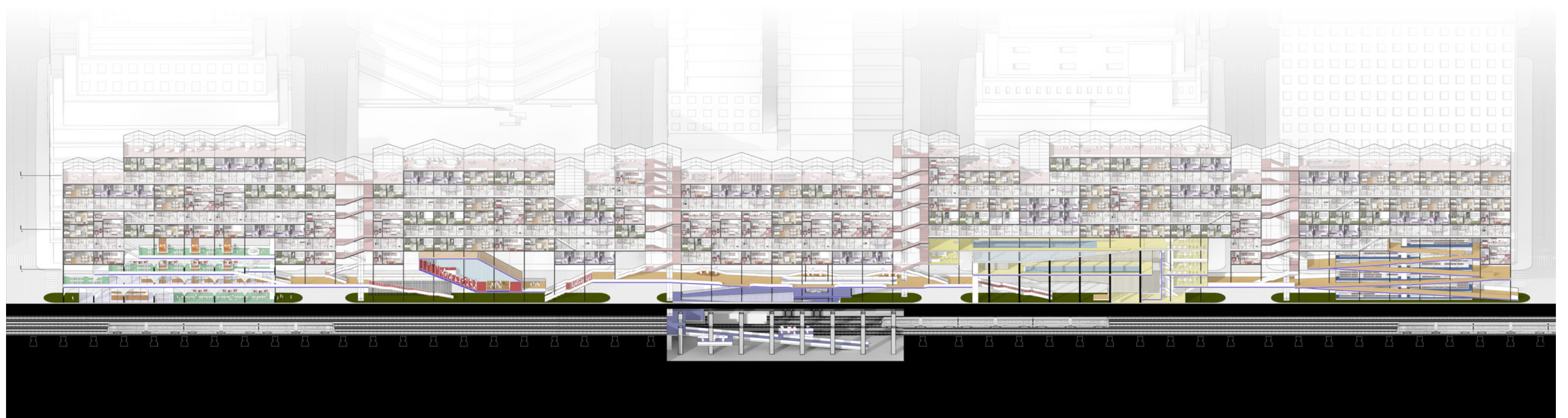
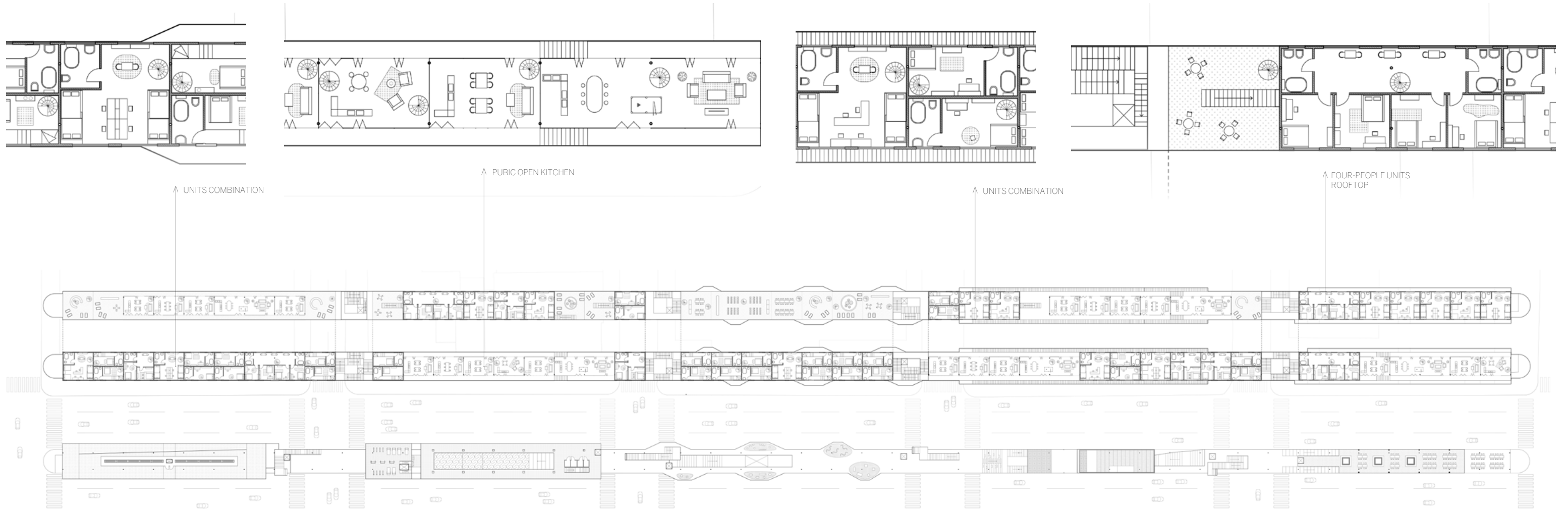

NEW RURAL-URBAN CULTURE Facing Depopulation

Team partner | Zihan Yu
GSAPP Studio | Summer 2020
Instructor | Juan Herreros
Site | Sacedon, Spain
Individual Effort | Scheme design, Construction design, Diagram making

This project focuses on developing a self-sufficient new rural-urban culture in Spain. Since nowadays, about 80% of the population live in cities rather than villages in Spain, the rural area is facing the severe problem of depopulation. The goal of this project is to bring people back from the city and repopulate the rural area.

Since people are moving to larger cities for community purpose and the opportunity to be part of something greater than themselves, the idea is to mix the city elements and rural elements in the villages to create a kind of new rural-urban culture, at meanwhile, try to achieve a self-sufficient circle to help form a new community. In this way, create more job opportunities in which young people can work remotely and start their own business and also can work for their community.

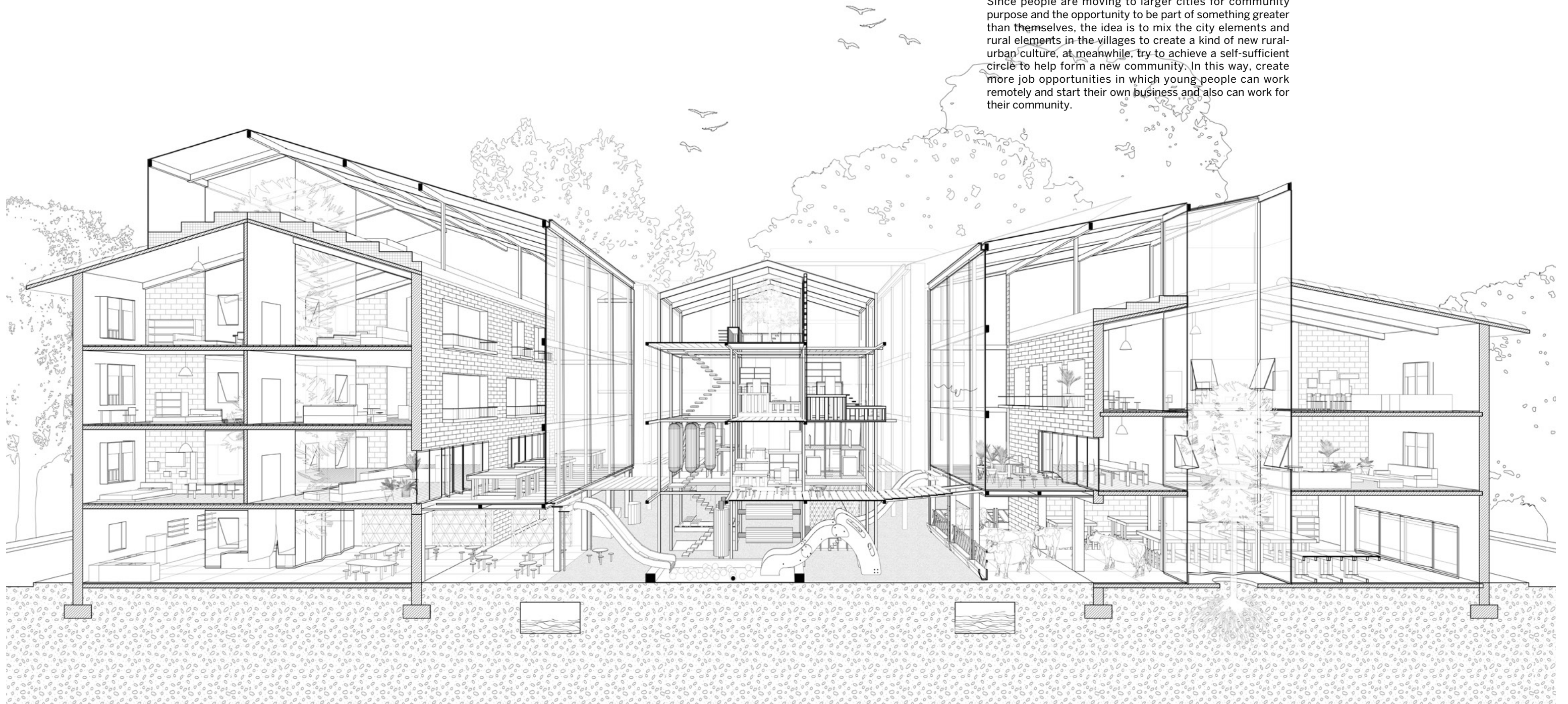

In Spain, roughly **81%** of the population now living in cities.

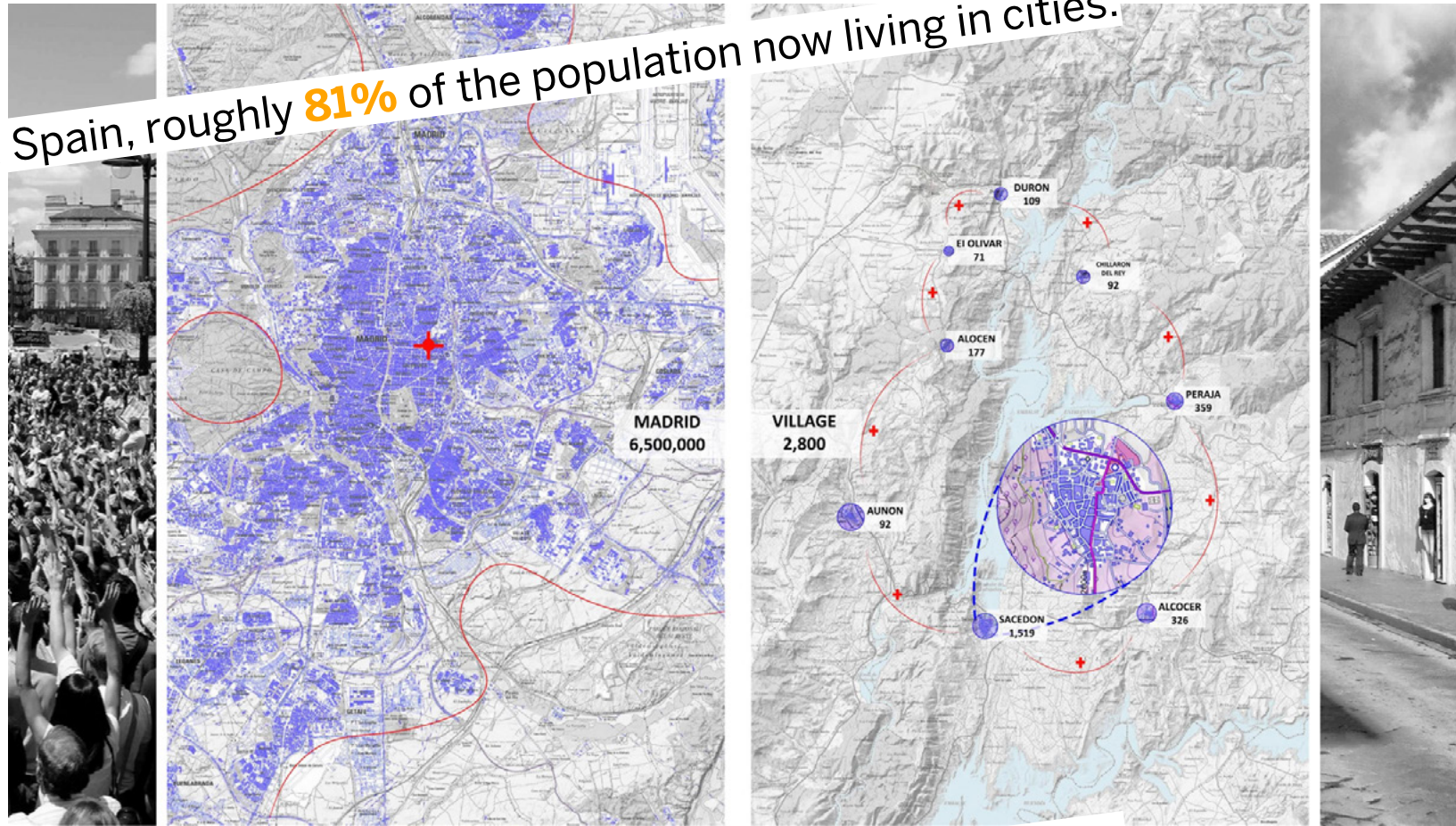

Original

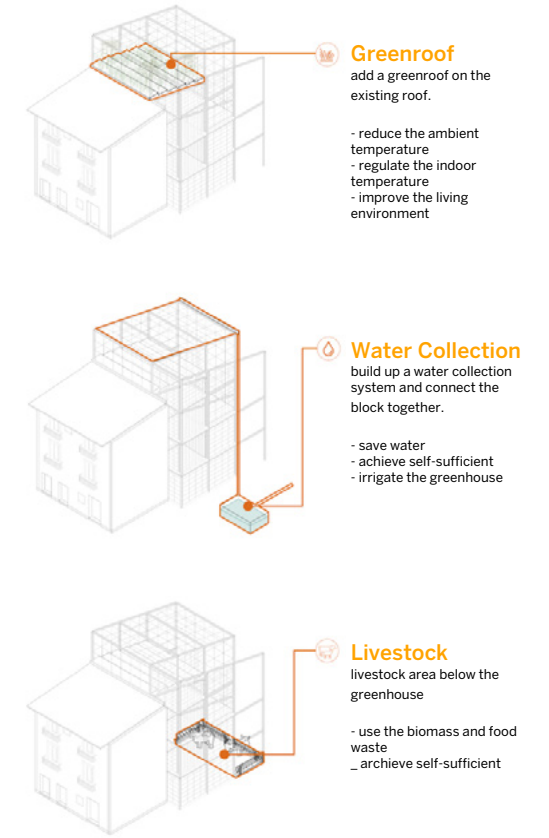
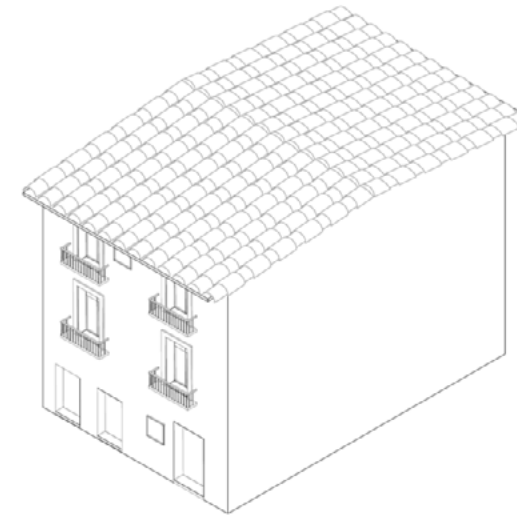

Renovated

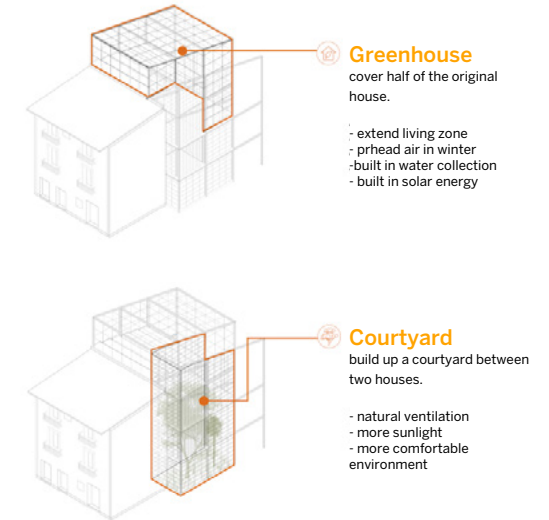

People are **moving to cities**, seeking **community purpose**.

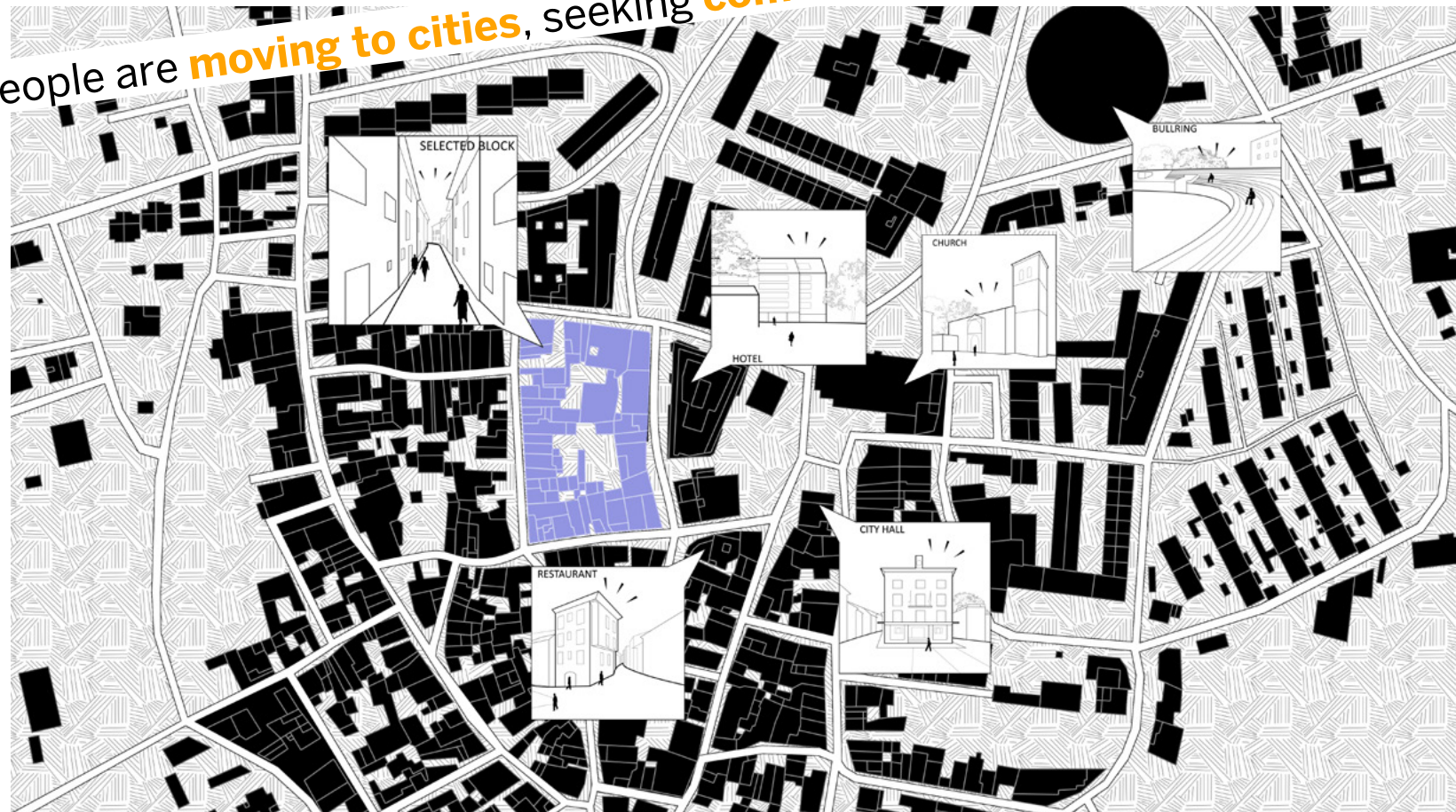

SACEDON: Renovating the Existing Building

We chose Sacedon as our site since, among most of the villages near the Tagus River, it has a typical Spanish village layout and both the population and occupation sizes are proper to work with. It is a place full of residential buildings and a few public buildings like city hall, church, and small stores. This amount of existing old residential buildings gives us great potential for further development. Inside the village, we chose the area which is highlighted in color. From the site plan, we can see it is an old residential block in which all the buildings are nested together and leaving the center area as vacant space.

The occupation for this block is about 60 people and only a small portion of the area is used for commercial stores. Based on that, we want to enrich the programs here by bringing what is happening in the city to this place, so that bringing people back from the city. Except for living space, working and commercial spaces need to be infilled and we also have the idea to develop this block into a self-sufficiency community in which the work opportunities will be largely increased and people not only work for the outside world but also their community.

- wood floor
- concrete on metal deck
- steel beam
- steel girder
- wood floor
- timber girder
- timber beam

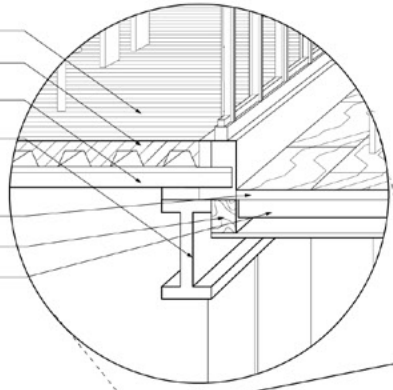

ROOF GARDEN

It serves the purpose of providing architectural enhancement, temperature control, habitats for wildlife and food.

COURTYARD

It brings the natural ventilation and sunlight to the house and provide a more comfortable living condition.

GREENHOUSE EXENTION

It not only provide planting area for the residents, but also extends the living area.

PORTICO

It enhances the social connection of the neighbourhood and provides a social area.

LIVESTOCK

SLOP ROOF

Keep the slop roof to remain the local elements of the village.

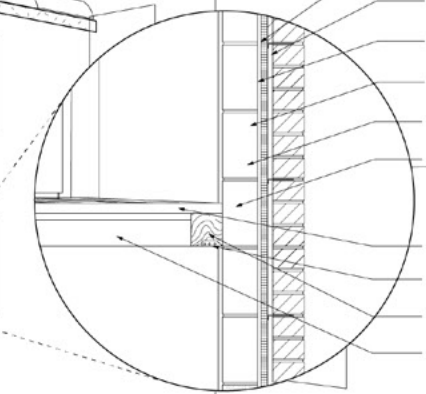

- anchor
- brick unit
- air space
- board insulation
- air barrier
- masonry unit
- wood floor
- steel joist anchor
- timber girder
- timber beam

TRADITIONAL FACADE

Keep the traditional facade to remain the local elements of the village.

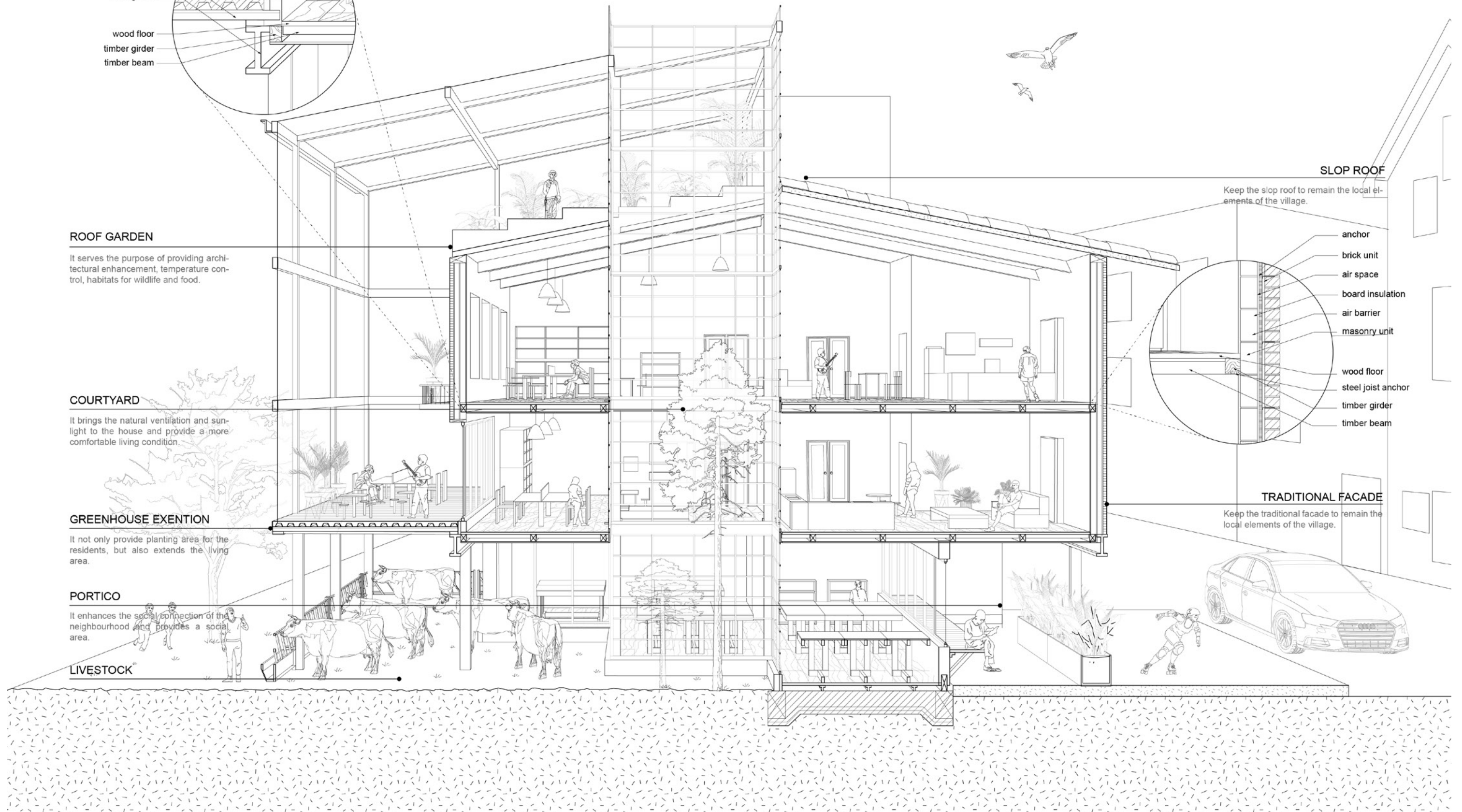

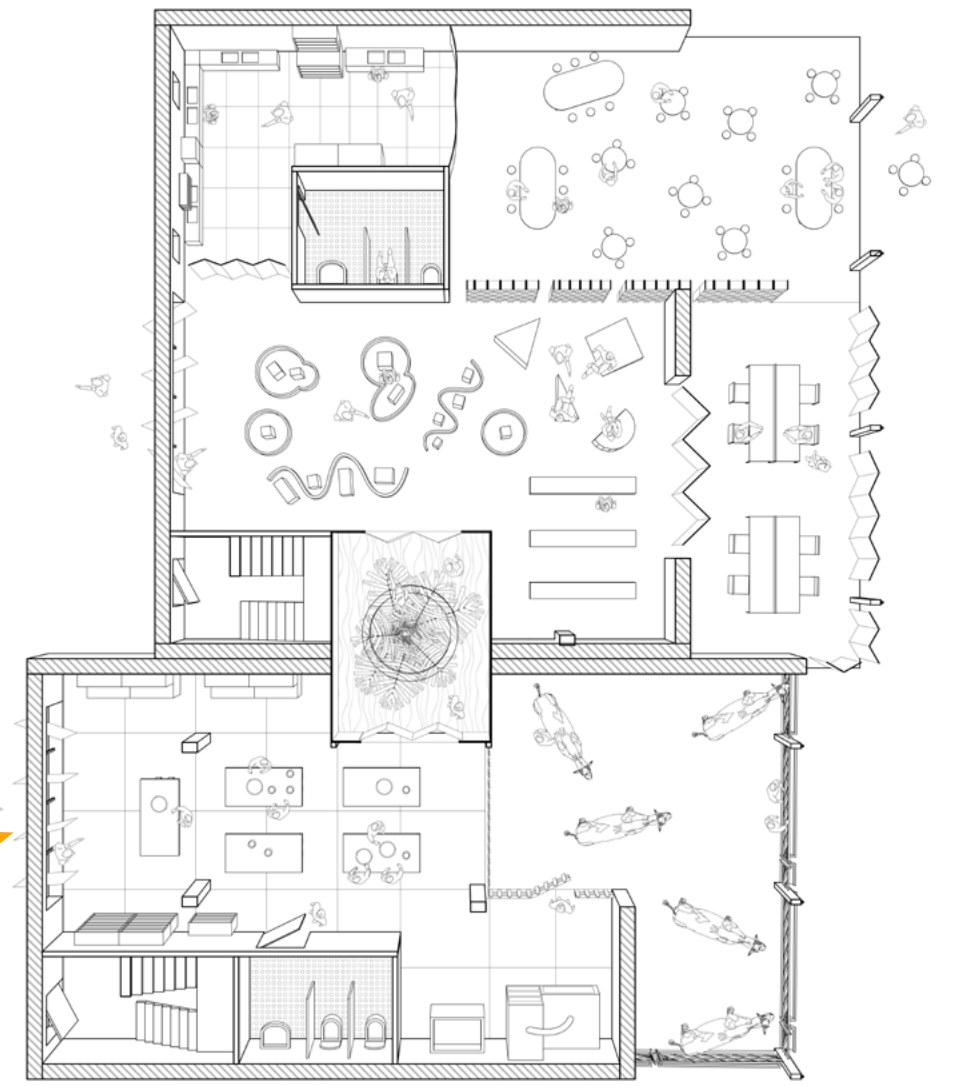
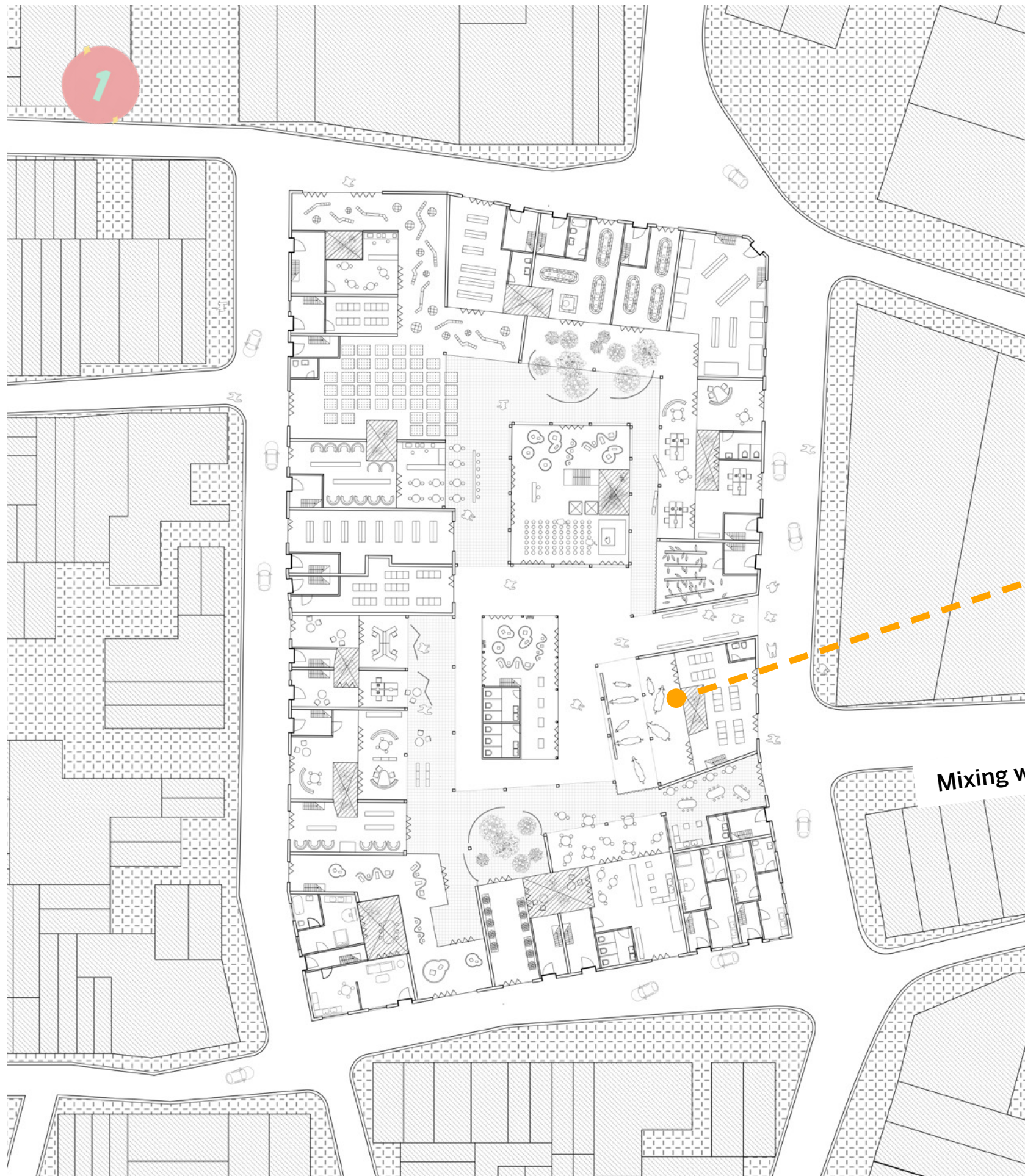

Mixing with Rural and Urban; Working and Living

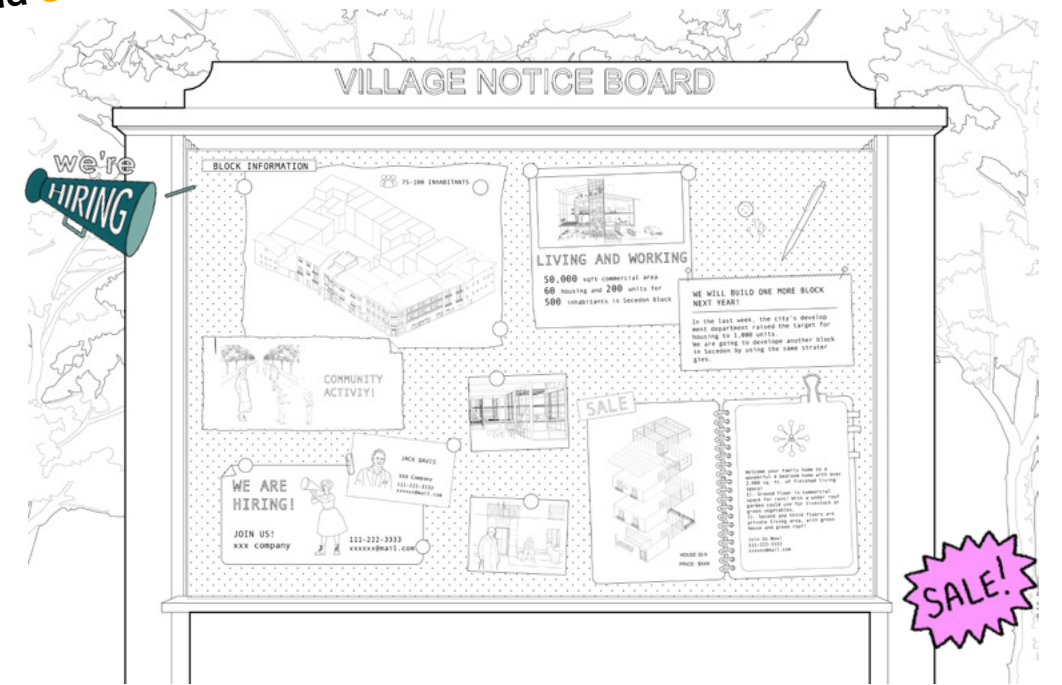

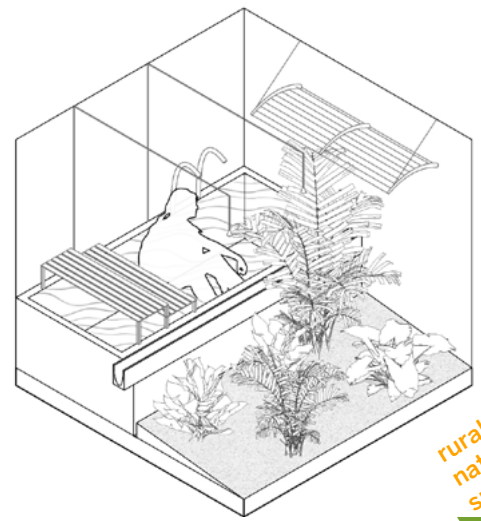

rural bath with
nature...
spa...

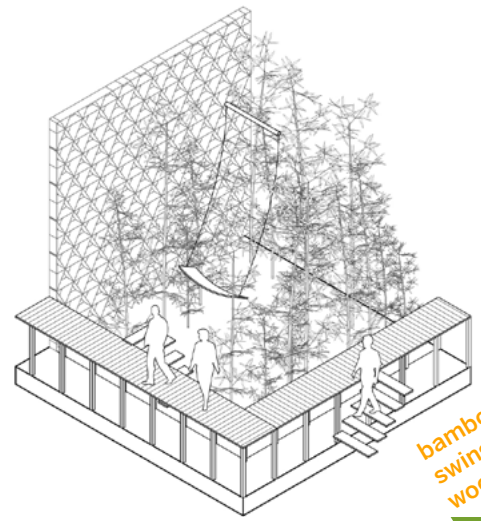

bamboo garden
swing...
wood bridge...

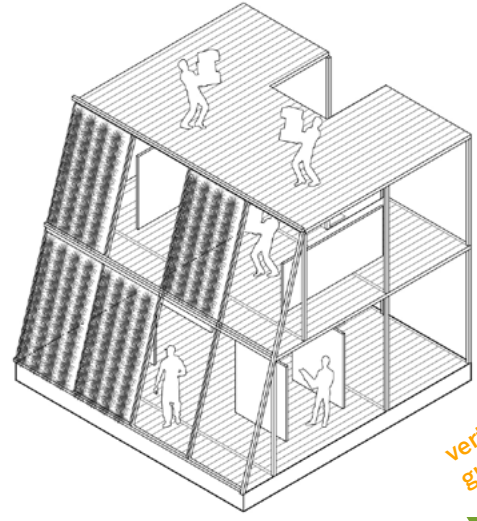

vertical farm
green plants...
organic food...

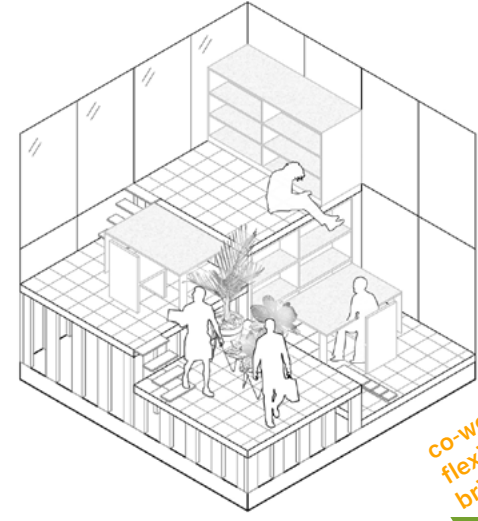

co-work space...
flexible...
bright...

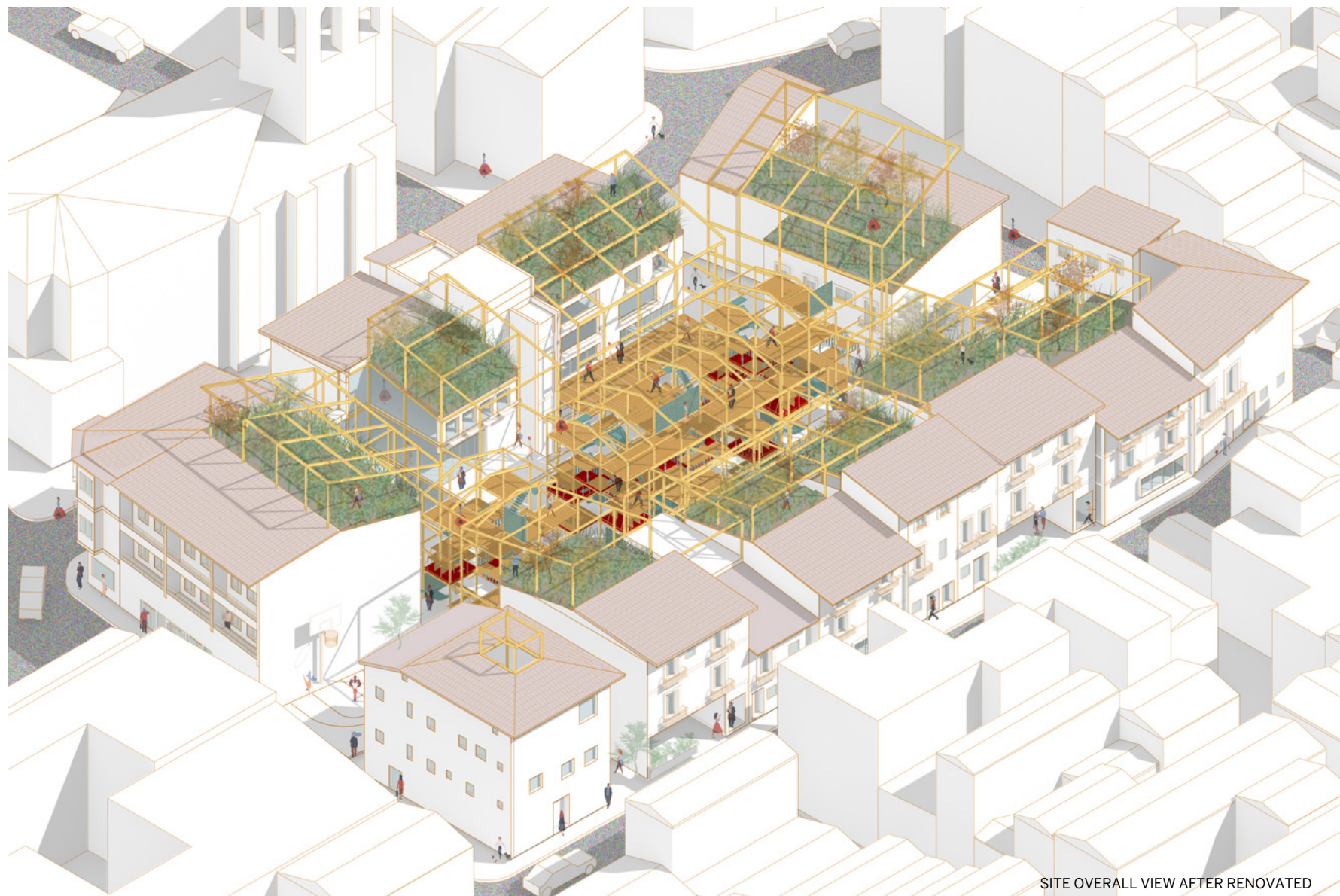

SITE OVERALL VIEW AFTER RENOVATED

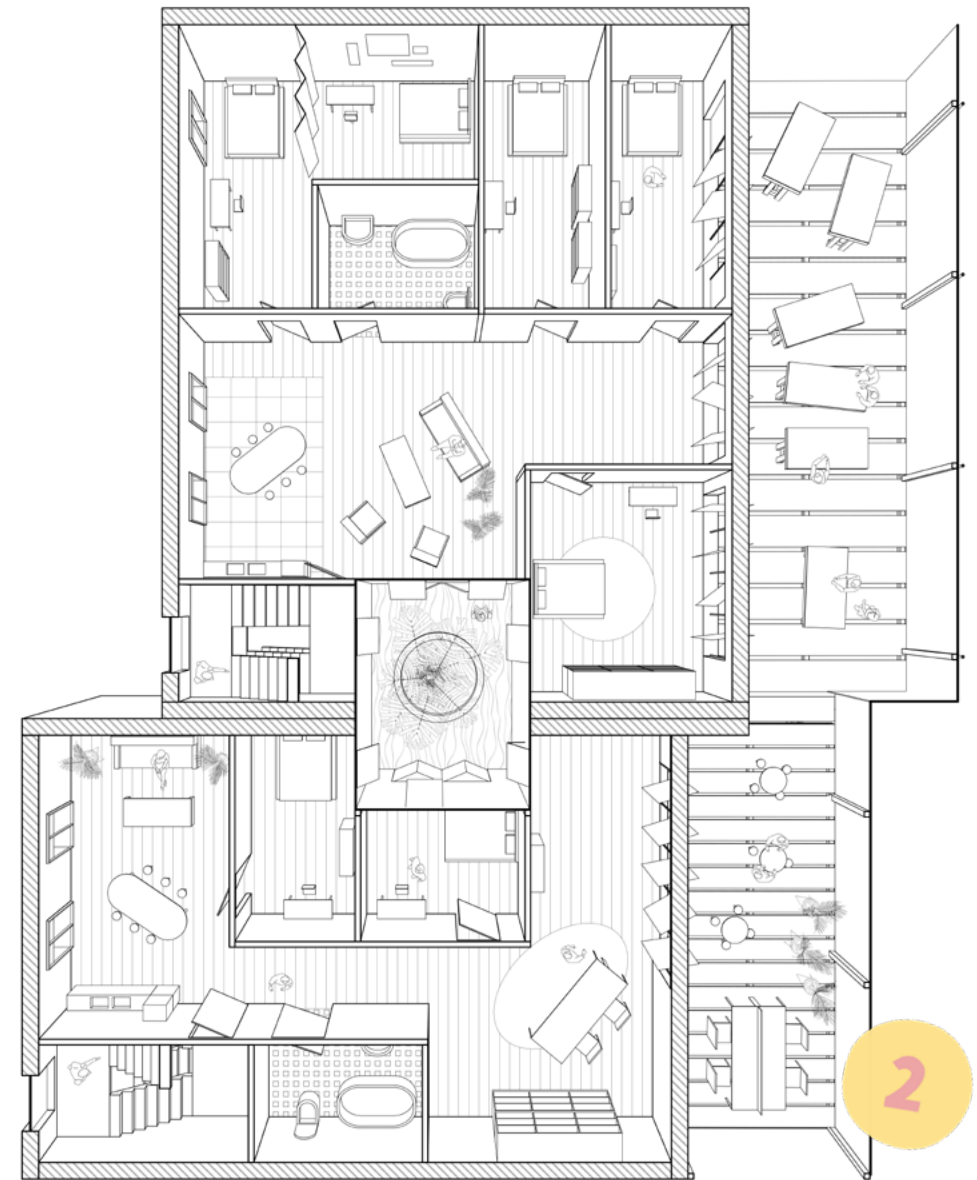

2



Self-sufficient **New** Rural Community

The new block provides more work opportunities and community activities. Roughly speaking, in each single house, it provides commercial working space and private living space. In the center of the block, there will be more community facilities. For the existing house, it has a current neighborhood connection and beautiful traditional facade that we like to keep, but the building just has single function. So, our developing strategies are adding courtyard, roof garden, greenhouse, livestock area and water collection.

Ground floor becomes more open and it enhance the social connection of the neighborhood and provide social area for the residents. The area filled with pink color is public programs like the restaurant, flower shop, livestock, and workshop. Between each building, we also

add vertical atrium to let sunlight in and for better ventilation. For the upper floor, people live in the existing buildings and work in the extended area which has been shown on the right. This kind of mixing with the rural and urban elements, living and working space help create a new community culture. People can work remotely right in front of their laptops or work locally just for this small-scale community. After renovated, most of the brick walls at the ground level are changed to a larger opening with windows and glass doors. The living space is also extended at the second level as the greenhouse is been constructed. This helps create a semi-closed and open, and semi-public and private space feeling. At the center, we are also adding more space for a playground, working, and living just help to support the demands of more people joining this community.

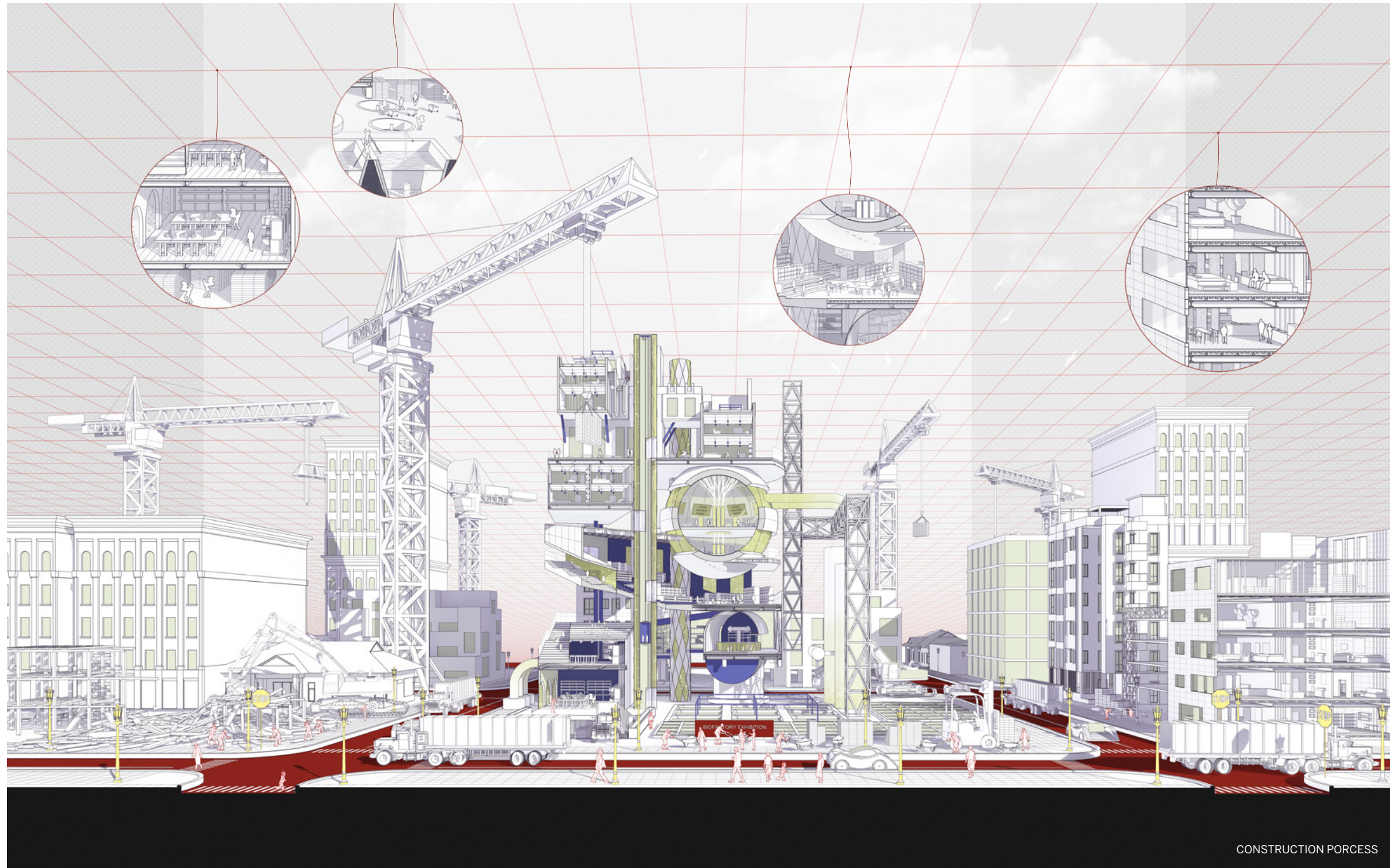

CONSTRUCTION PORCESS

04

BIO-COMMUNITY
"the Green New Deal"

Team partner | Zihan Yu
 GSAPP "Green New Deal" Studio | Fall 2019
 Instructor | David Benjamin
 Site | Austin, Texas
 Individual Effort | Scheme design, Construction design, Model making, Diagram making

This project focuses on achieving a negative carbon emission community by reducing the carbon emission during the whole building lifecycle including embodied energy and operational energy. As we all know, cement production takes 8 percent of the global carbon emission and concrete is the most consumed material on earth. Over 70% of the world's population lives in a structure that contains concrete and all buildings—even wood buildings—contain a significant amount of concrete.

Also, among the global carbon emission, the building sector combining the embodied carbon and operational carbon also take a large part up to 40 percent of the total. How we gonna achieve a negative carbon emission society by 2040?

Bio-concrete which can be produced in small scale factories using biomaterial mixing with solid wastes and byproducts in room temperature helps largely decrease the carbon dioxide emission at the industrial process. Also, by injecting the CO2 which collected from concrete plants upgrades low carbon emission to negative carbon emission. Algae which can generate electricity help saving energy and changes human lifestyle. Based on its various possibilities, it can turn into protein food, energy-efficient furniture, and vehicle. This combination of two materials draws out a green future for both architectural scale and human scale.

Meanwhile, the whole system helps to form a comprehensive market flow which stimulates the demands for work and producing more residential resources.

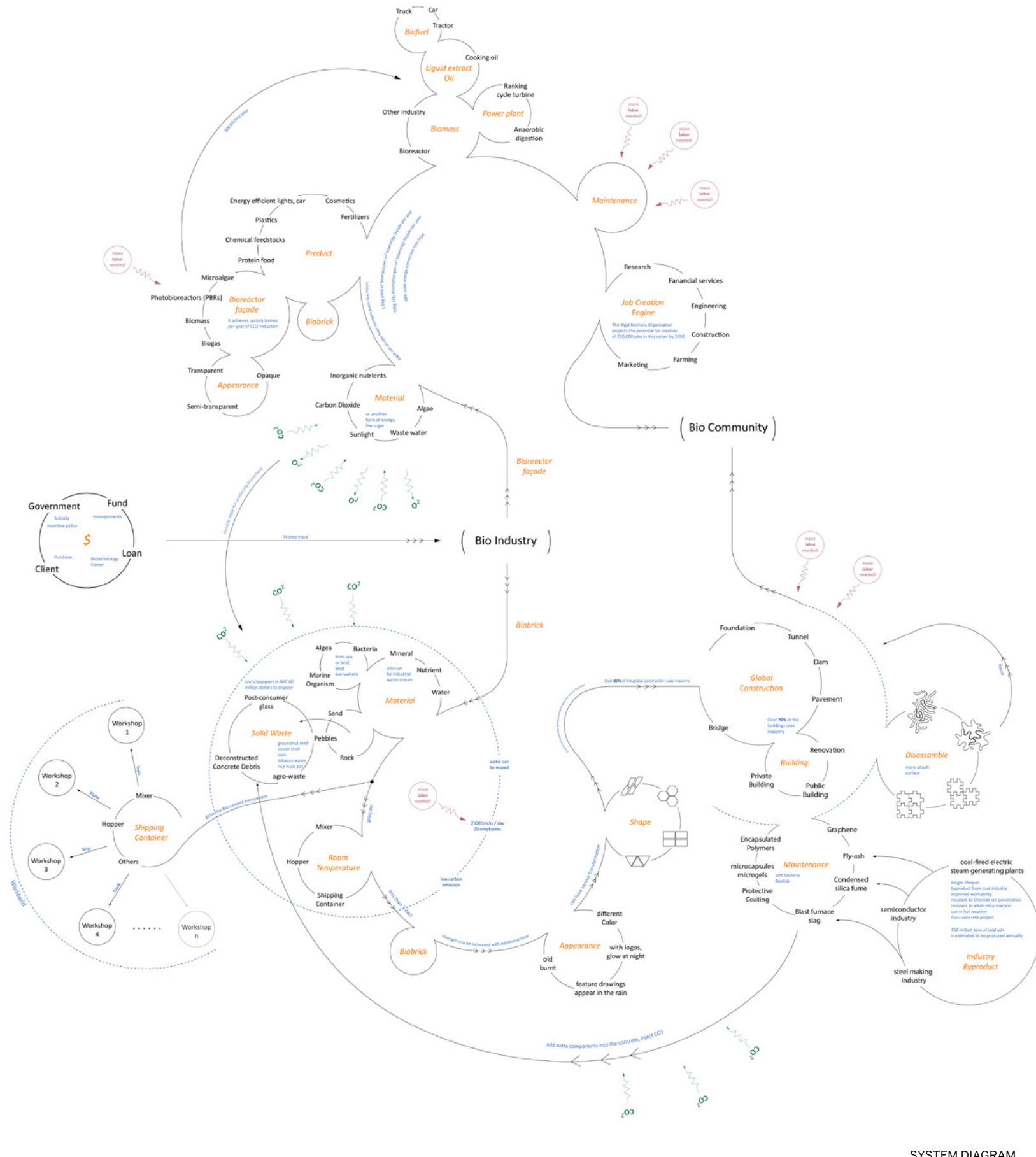

SYSTEM DIAGRAM



NEIGHBORHOOD CONCEPTION

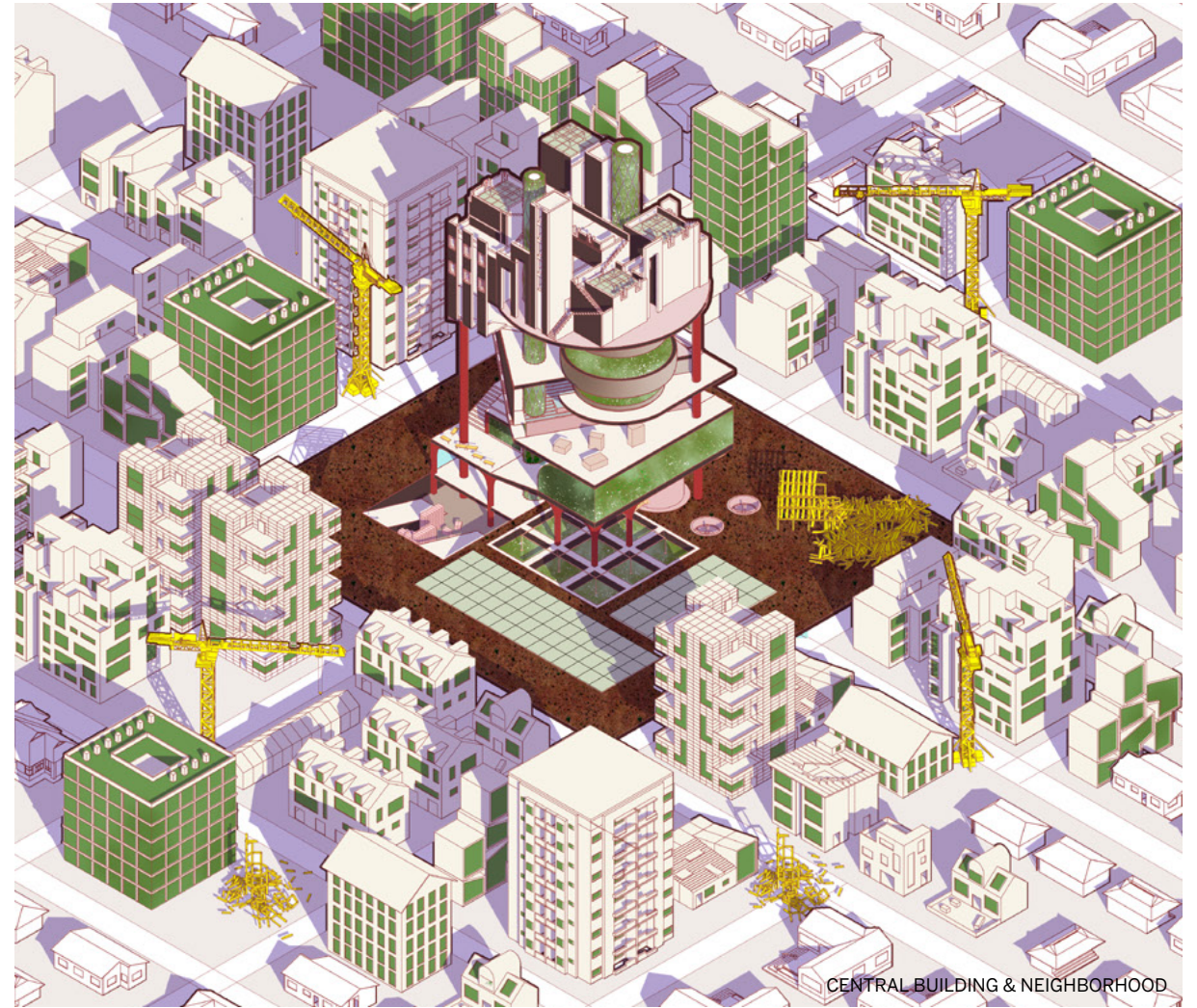

CENTRAL BUILDING & NEIGHBORHOOD

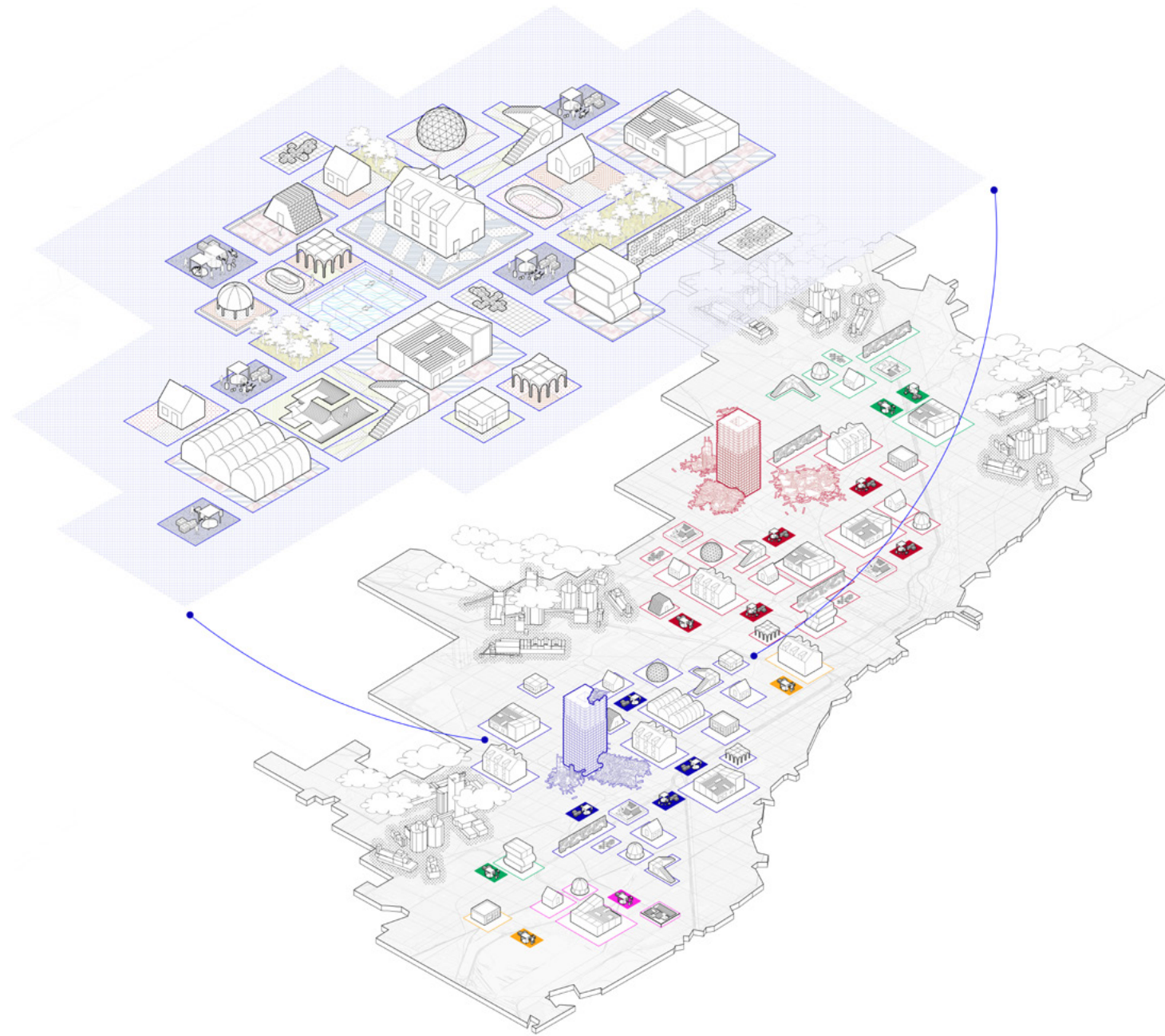

BIO-CONCRETE & ALGAE ENERGY SYSTEM

We are looking into a new type of bio-concrete material to replace the traditional concrete and using algae energy system to reduce the embodied energy of buildings. In response to lower carbon footprint, our project focuses on developing a multifamily building structure using bio-cement and algae as the medium to achieve a sustainable and environmental-friendly system. The biobrick we are using is made out of bacteria, water and combining the demolished material from existing building. The algae energy system is constructed by algae bioreactor which can produce biomass, heat and oxygen to both help provide the energy needed for producing the biobrick and also for building uses. Meanwhile, the whole system helps to form a comprehensive market flow which stimulates the demands for work and producing more residential resources.

the detailed system diagram basically showing the money input from government, client or funds to the bio industry. The biobrick can grow by themselves in room temperature for about 2-3 days without any heating which let them won't generate carbon dioxide

like traditional brick does; also, this easily accessible production method can help forming small individual industries instead of big cement plants. For the algae reactor we are applying it to the window façade and its later maintenance also stimulates the labor market after installed. Start designing, we chose Texas as the site since it is one of the leading states of cement producing and also the cement consuming. And we continue narrow down to Austin in Texas as it has many single-family houses which have already permitted by government for demolishing, as you can see from the purple dots the map shows.

Start establishing this system, we propose the government will implement a range of policies to encourage and standardize the whole process. For the first phase, the goal is 20 percent of the residential houses must be built out of biomaterial and reduce 30 percent carbon footprint of residential houses. There will be an evaluation energy cost policy to help citizens justify quality of the building and then they will follow the rebuild policy to use biobrick product and algae product building the new building system.

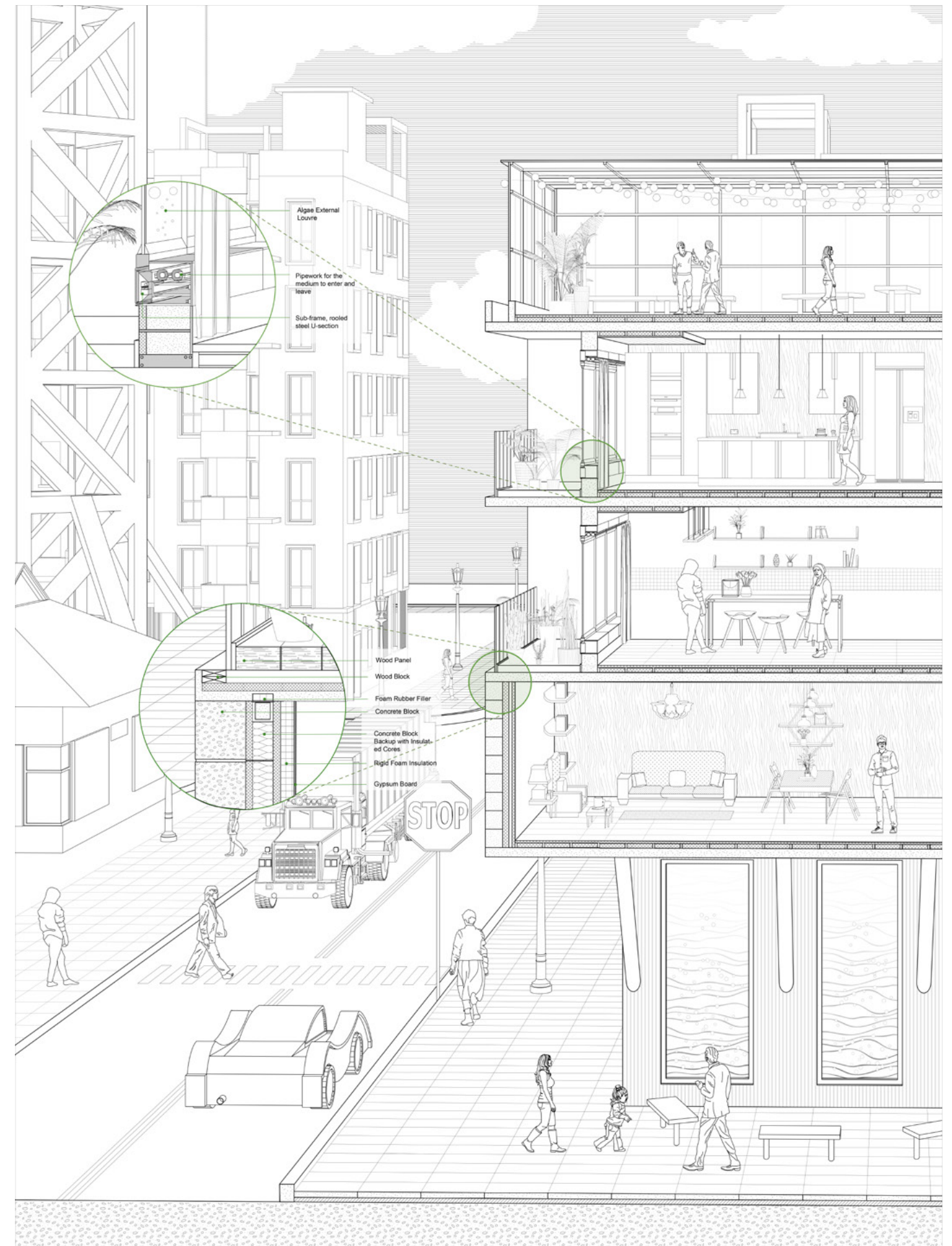

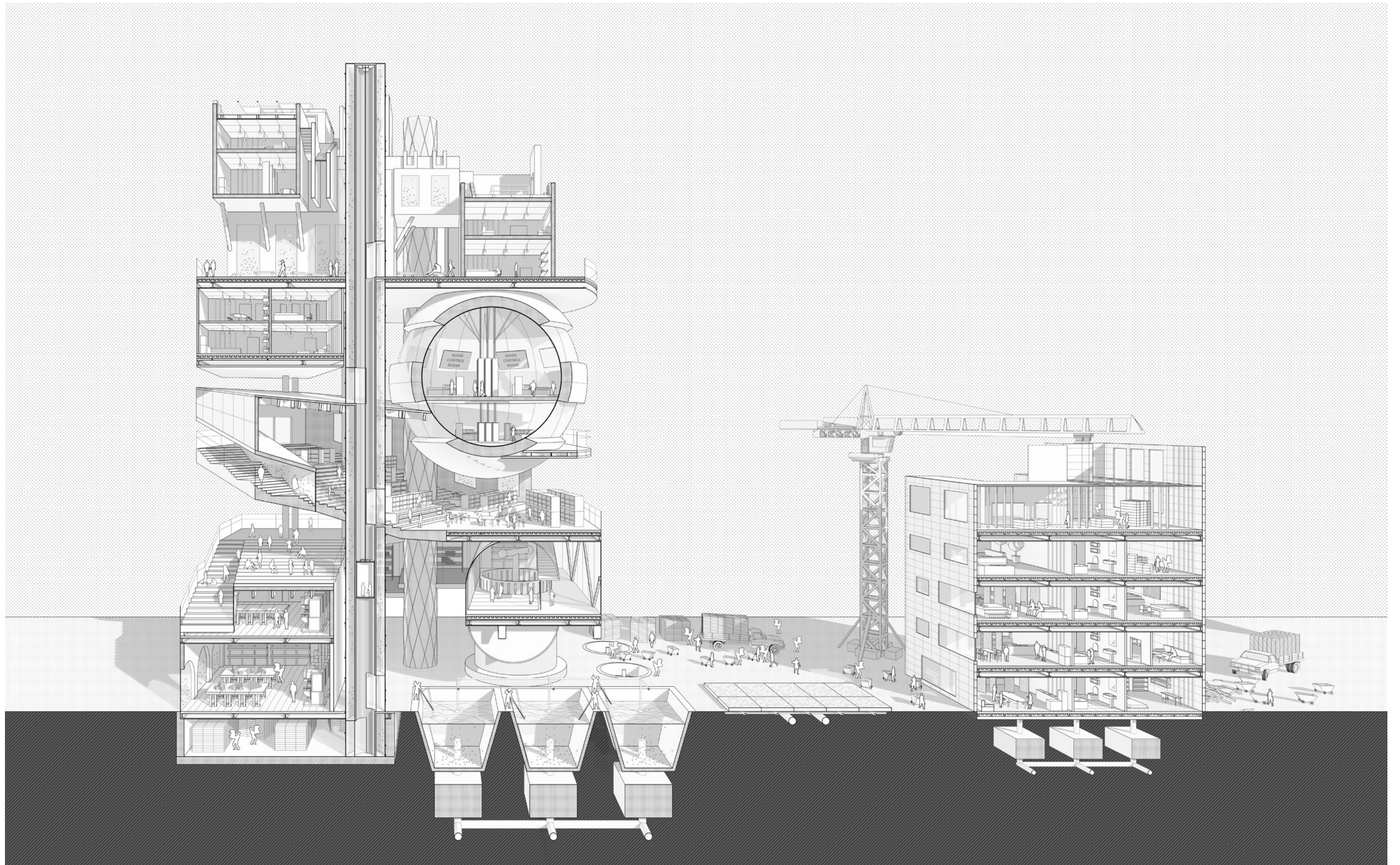

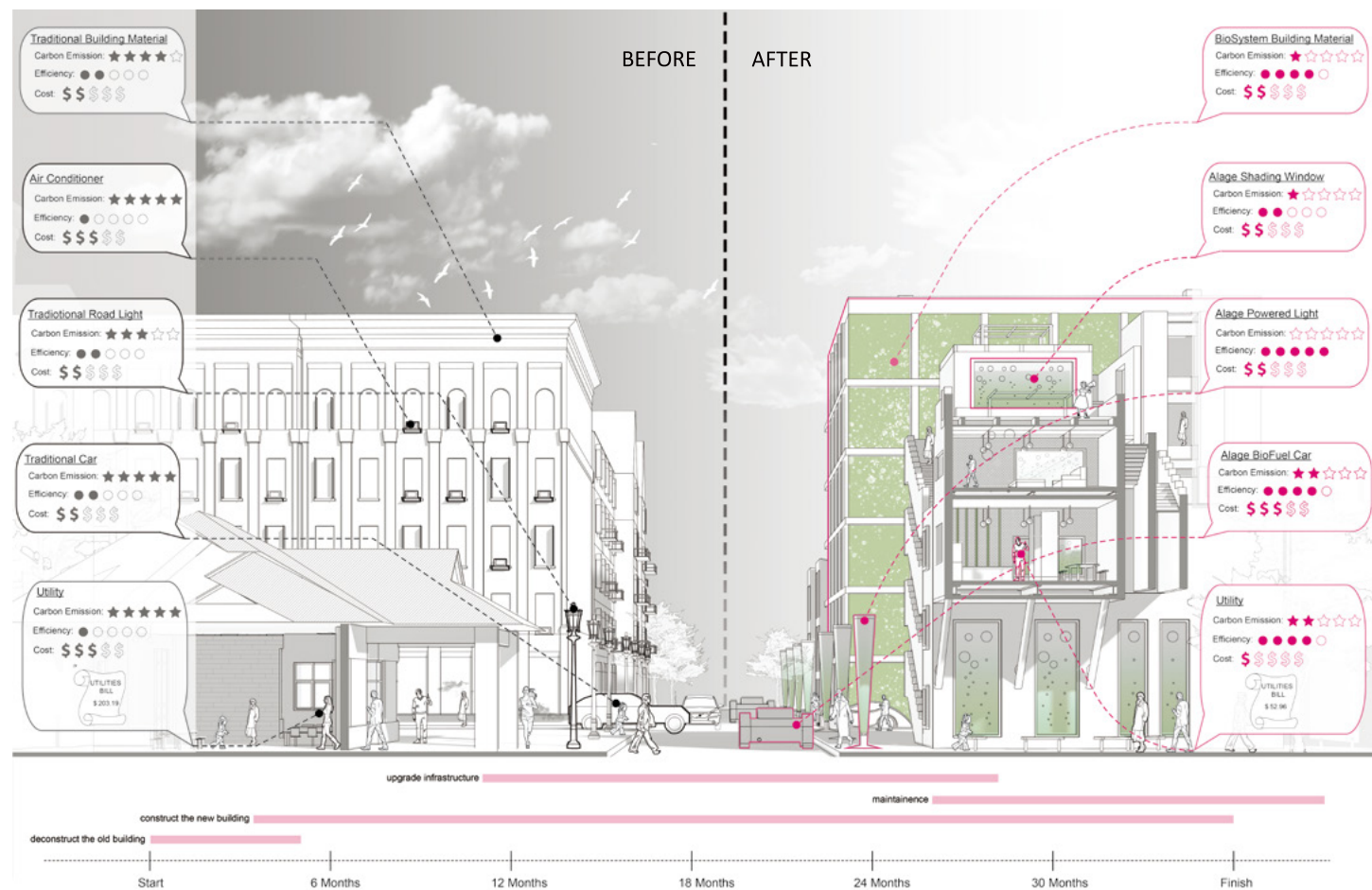
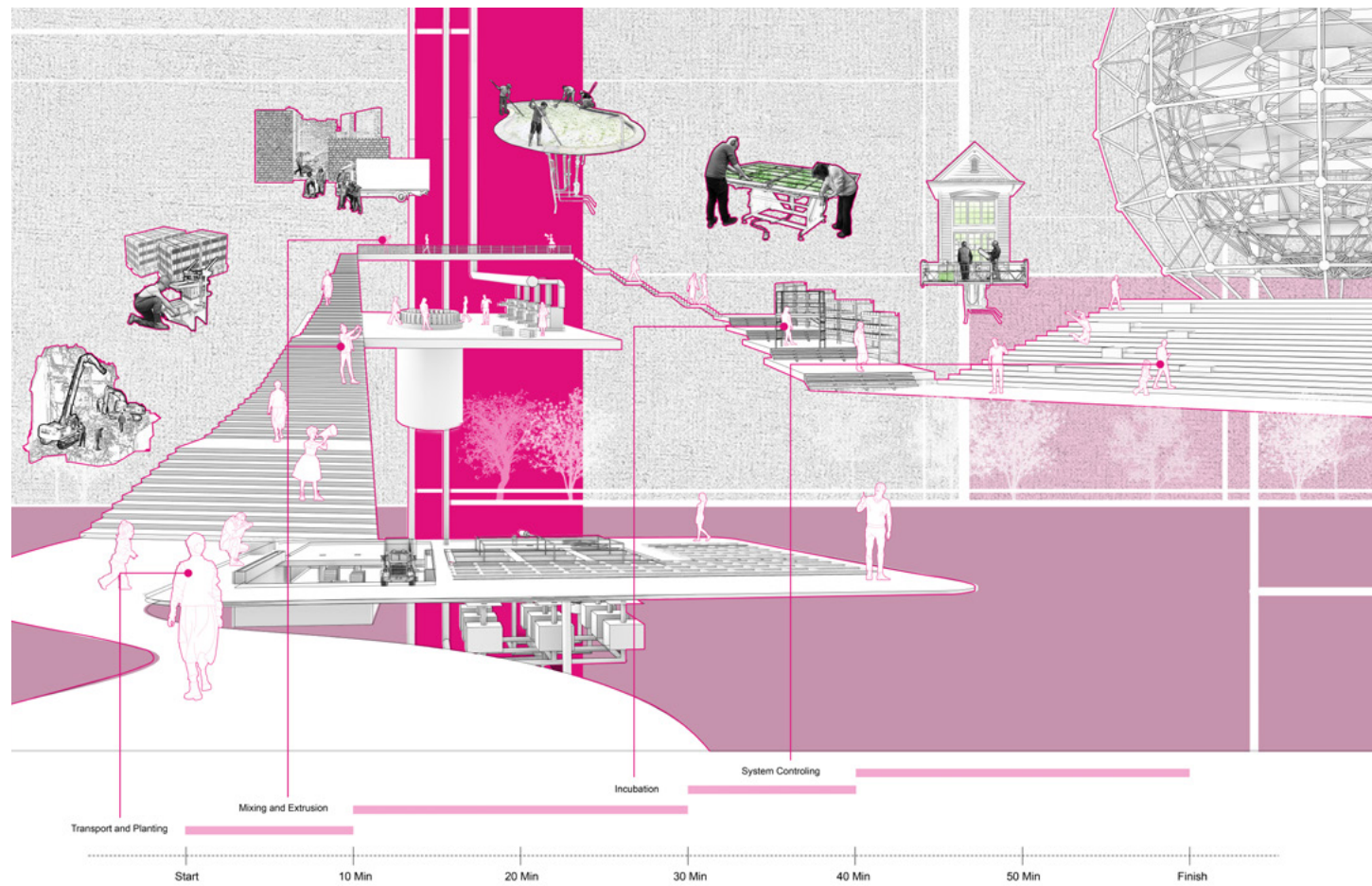

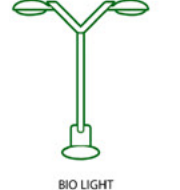
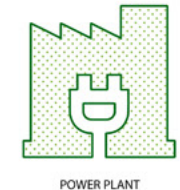
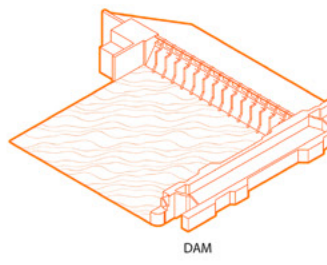
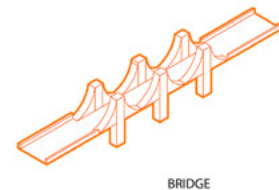
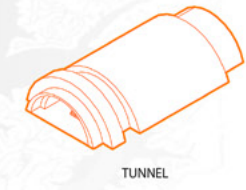
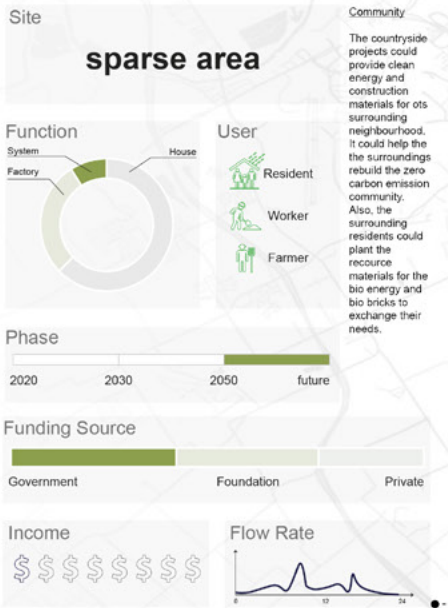
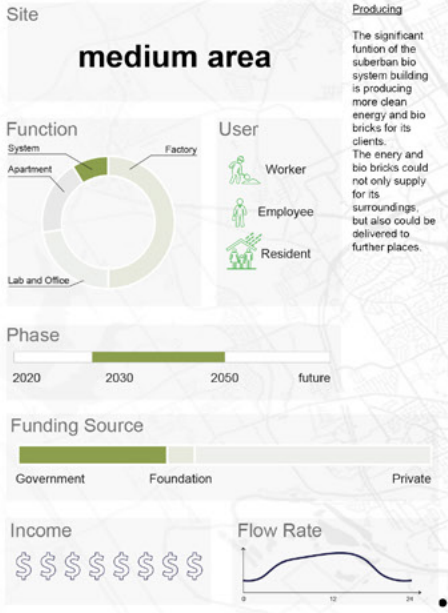
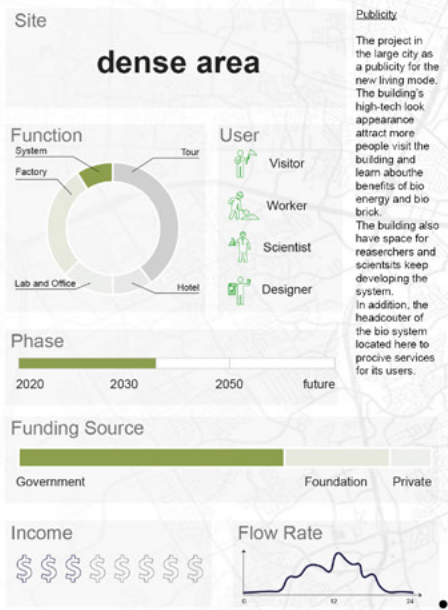

further impacts of using algae further impacts of using bioconcrete

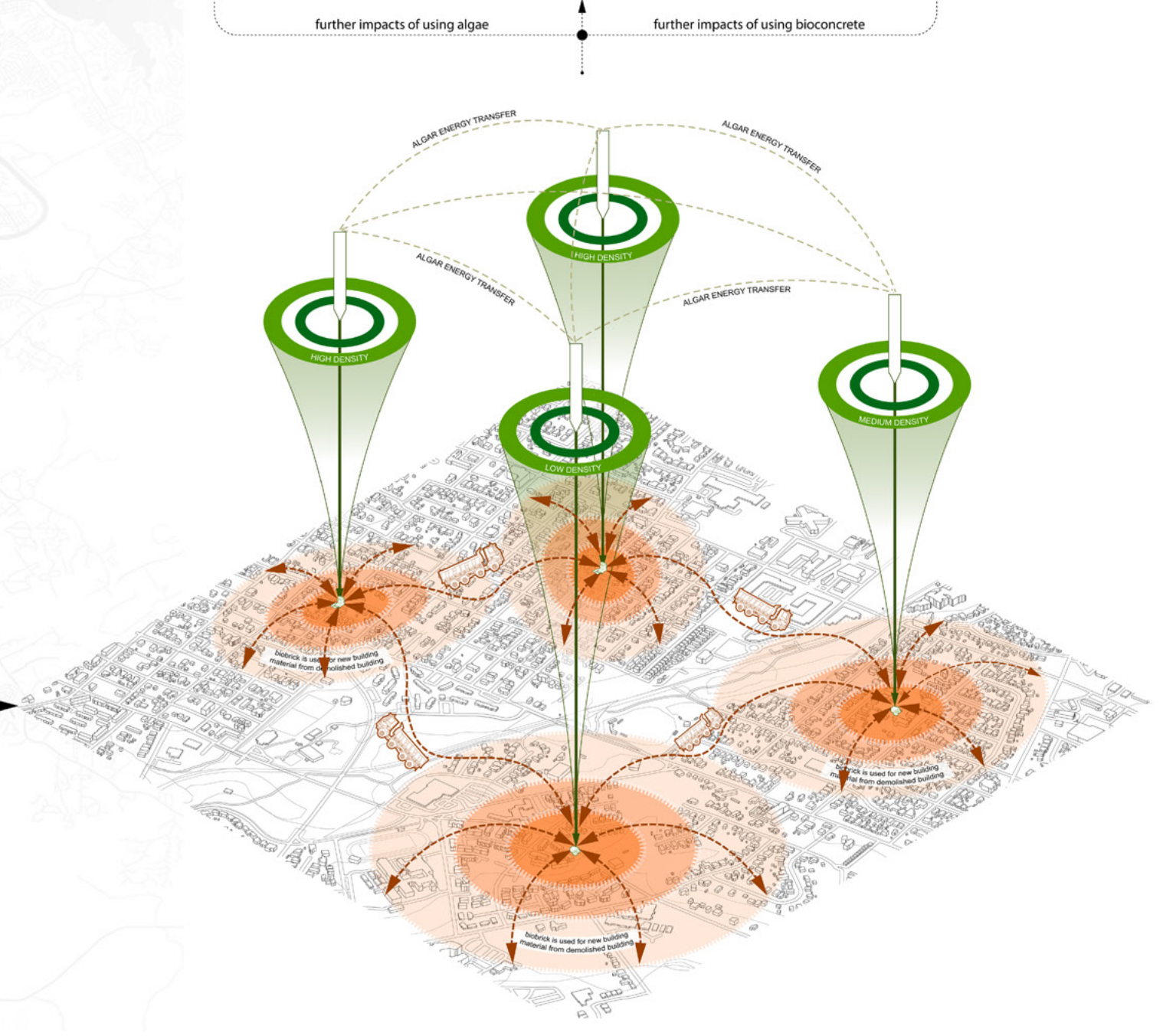

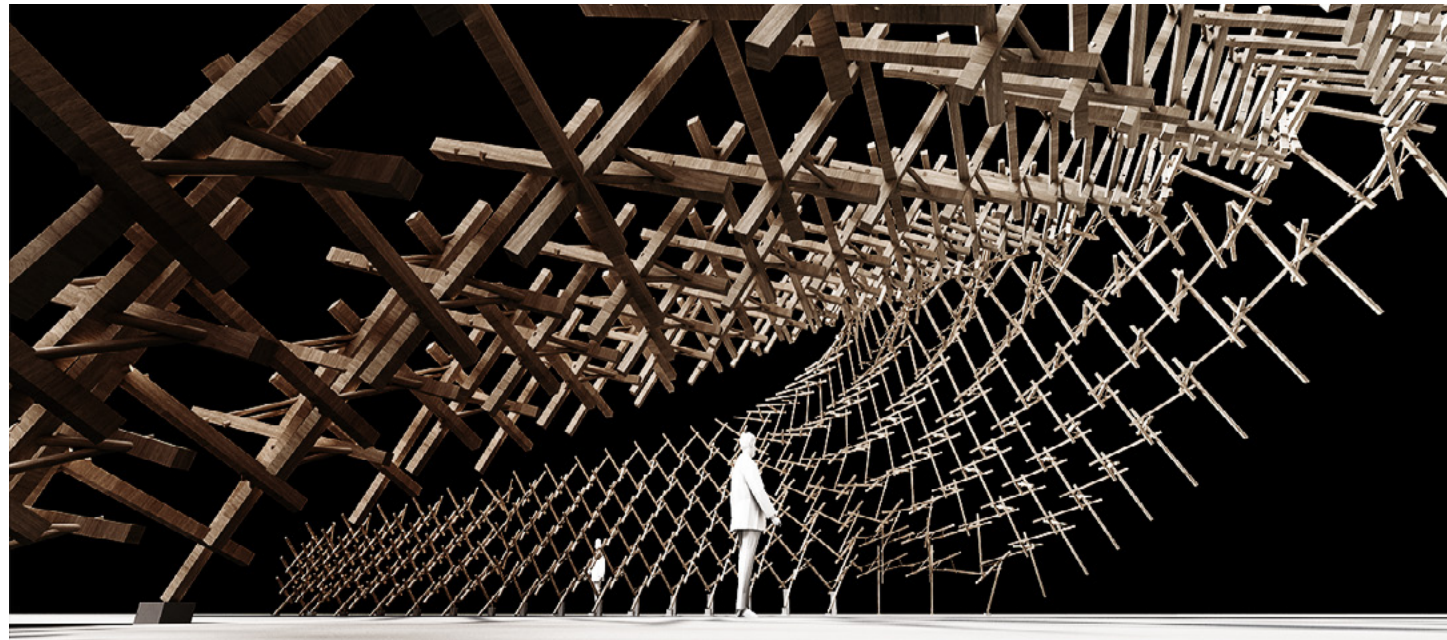

05

WOOD-JOINT PAVILION

Team partner | Ziqi Feng, Jieran Geng, Huajie Ma, Yanwei Yang
 RPI Robot Studio | Fall 2017
 Instructor | Lonn Combs
 Individual Effort | Scheme design, Working with robot arm, Assembly

This project focuses on designing an adaptive and parametrically unitized wood structural system utilizing robotic fabrication and customized joinery system. A treated robot arm as a new kind of element engaged in this studio, our purpose is to dig out possibilities that how we can let robot arm to participate in the assembly process.

The system is constructed in rectangular wood stick, round wood stick, and wire. For better constructing the model, the rectangular wood sticks are divided into three types which each has a different angle of the holes and can be drilled by the robot arm. Furthermore, this system is constructed without any glue and the joint is still very strong and stable.

rotation tests



ANGLE: 0.0
SCALE: 1.025



ANGLE: 10
SCALE: 1.025



ANGLE: 20
SCALE: 1.025



ANGLE: 30
SCALE: 1.025



ANGLE: 40
SCALE: 1.025

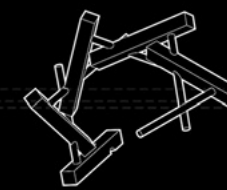

ANGLE: 50
SCALE: 1.025

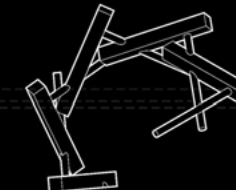

ANGLE: 60
SCALE: 1.025



ANGLE: 70
SCALE: 1.025

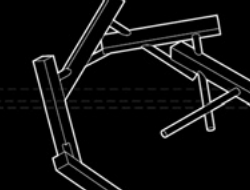

ANGLE: 80
SCALE: 1.025



ANGLE: 90
SCALE: 1.025

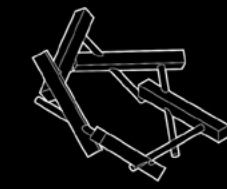

ANGLE: 100
SCALE: 0.9

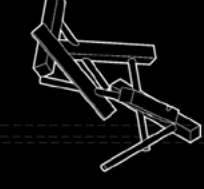

ANGLE: 110
SCALE: 0.8



ANGLE: 120
SCALE: 0.7



ANGLE: 130
SCALE: 0.6

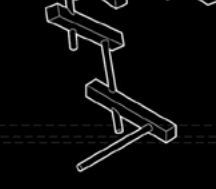

ANGLE: 140
SCALE: 0.5



ANGLE: 150
SCALE: 0.4

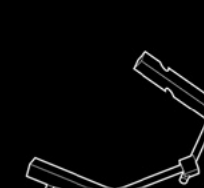

ANGLE: 160
SCALE: 0.3

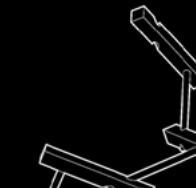

ANGLE: 170
SCALE: 0.2

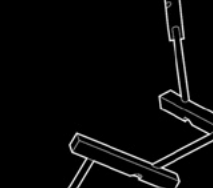

ANGLE: 180
SCALE: 0.1



ANGLE: 190
SCALE: 0.05



Tensile member connection, Plan, blown-up

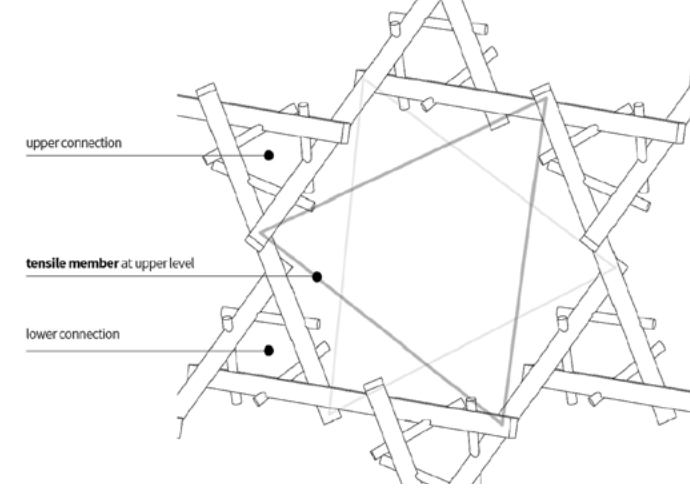

Tensile member connection, Sect, blown-up

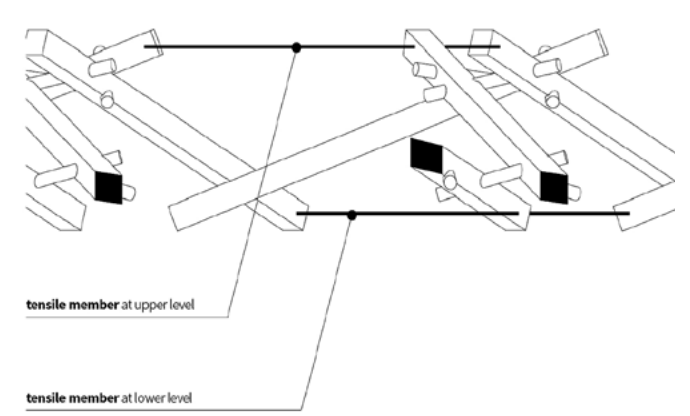

■ scheme02
/ TRIANGULAR FRAME



■ scheme03
/ HEXAGONAL FRAME

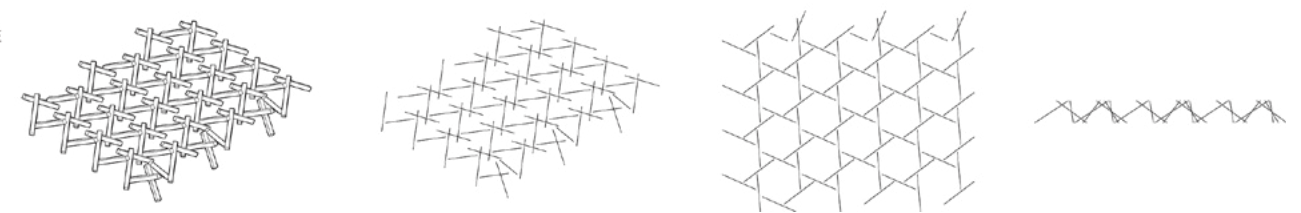

PREVIOUS PATTERN GRID DEVELOPEMT

■ grid iterations

Angle 20
Scale 1.16

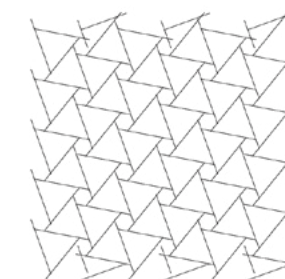

Angle 30
Scale 1.16

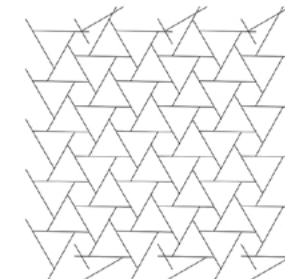

Angle 40
Scale 1.16

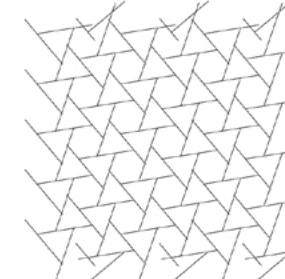

Angle 50
Scale 1.10

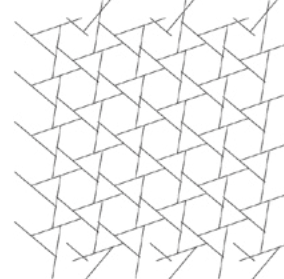

Angle 60
Scale 1.00

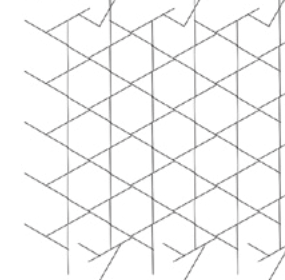

Angle 70
Scale 0.89

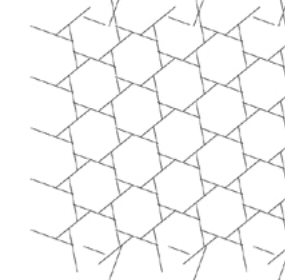

Angle 80
Scale 0.75

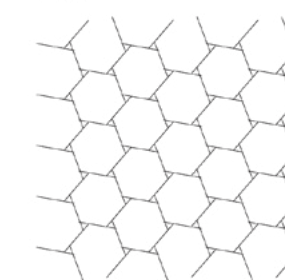

Angle 90
Scale 0.59

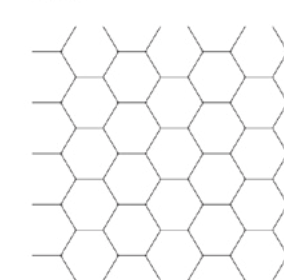

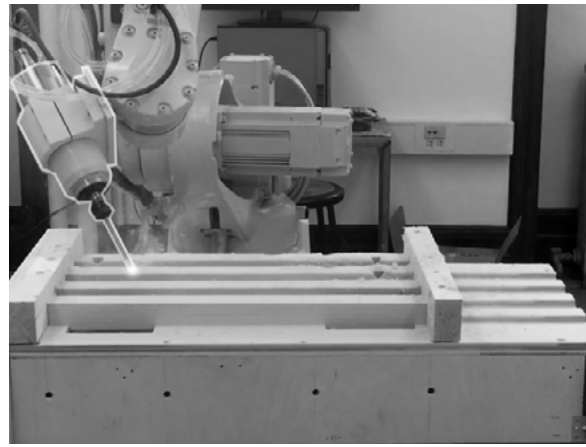

00:00:30

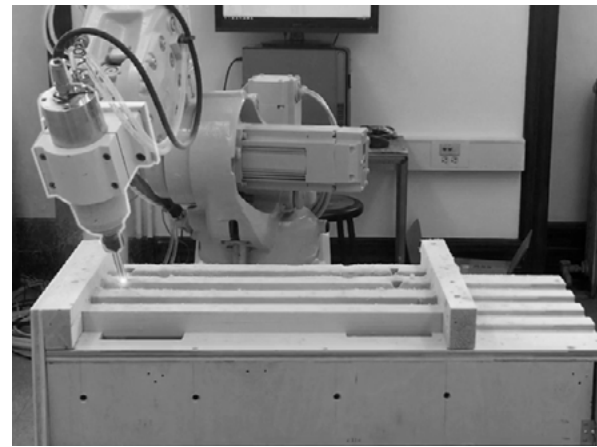

00:01:00

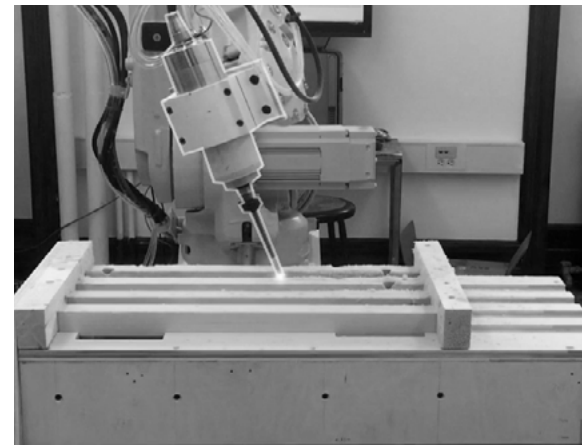

00:01:30

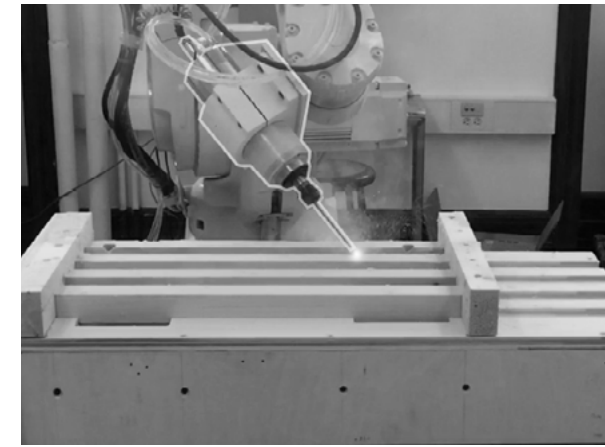

00:02:00

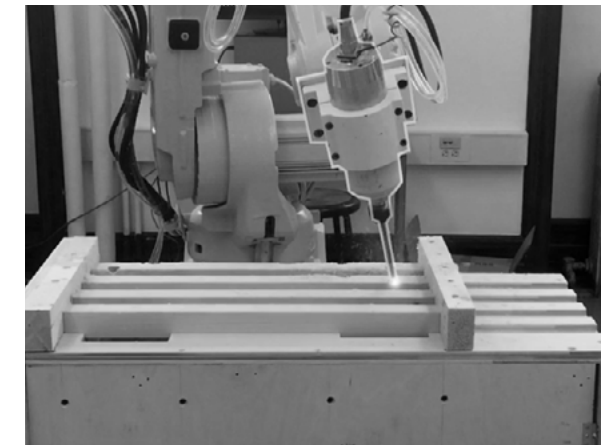

00:02:30

SELF SUPPORTING SYSTEM & ROBOT

The strong wood joint system has been discovered a long time back to ancient China and Japan. The complexity of the joint details is elaborated designed to fit them together without glue and also do not fall apart.

But for our system, it is not a such a complex one but it also works out similar. Instead of designing the detailed joints, we are designing a larger picture of how the system would look like and work. By experiencing the interconnecting between different angles of the rectangular sticks and round sticks, we find an organizing system which each branch is stored in a certain amount of angles. Then the relationship between each branch can create an interlocking moment where the joint

system without glue appears as shown in the upper photo. The whole system is flexible when it lies on the plane surface but when it is lifted up, it becomes a self-supporting system. Later on, we simplify the system and make it more efficient and can also develop in both x, y and z-axes. The grid system is created under this situation which is more generic and flexible to apply on any curvy surfaces which becomes a kind of skin strategy for contemporary architecture. While using the robot arm to drill the hole, we mark the different types of sticks by painting three different colors on the one end of each stick which are black, grey and white. This is not only easier for us to recognize the specific type, but also create an interesting phenomenon when the model is finished, people can see only one type of the color when they stand on three different locations.

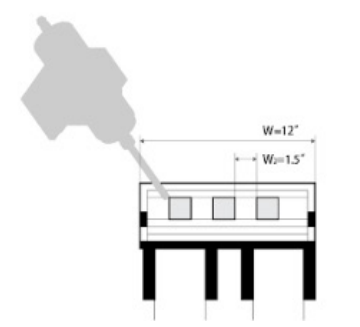
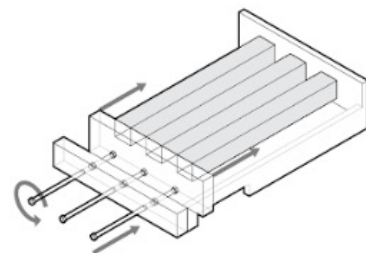
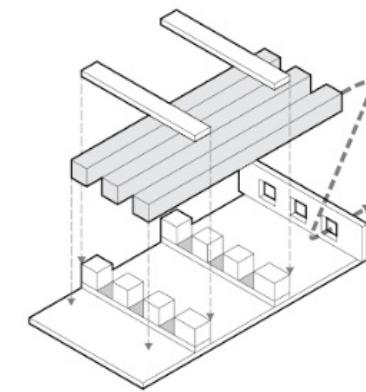
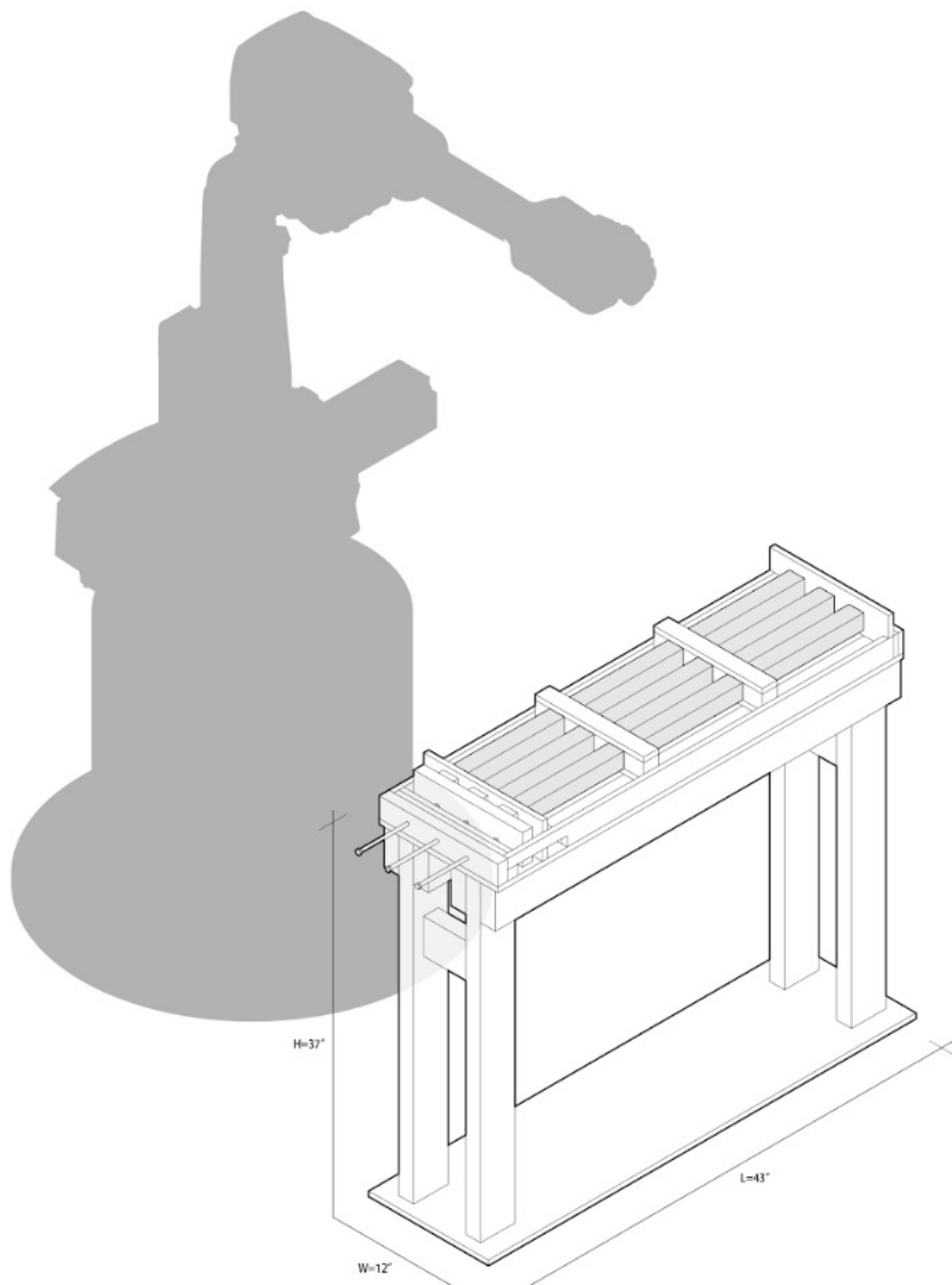

ROBOT FIRST GENERATION

Screw-in clamp
maximizes stability

Dust holes
leaves space for easy cleaning

Trapezoidal plate
increases drilling stability

Side bracings
ensure lateral stiffness

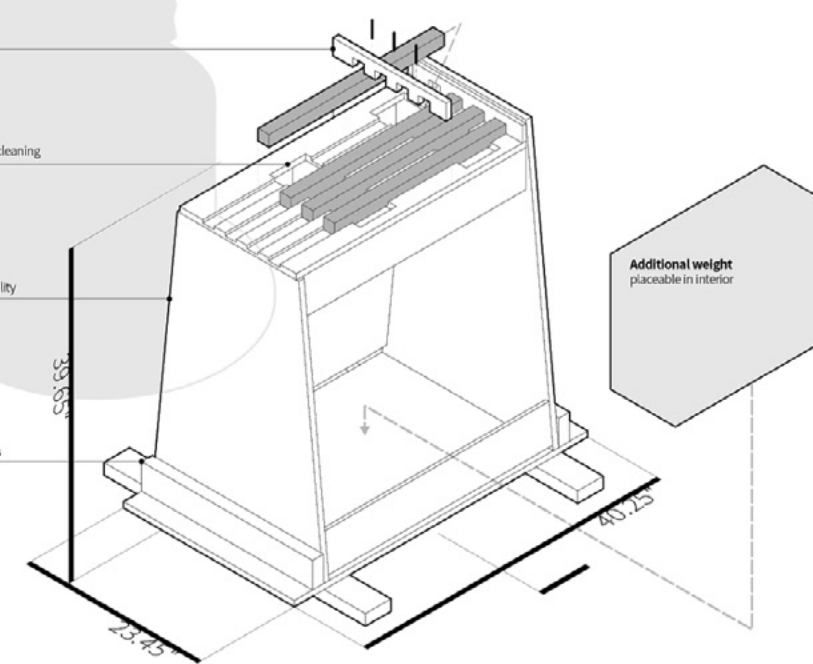

Additional weight
placeable in interior

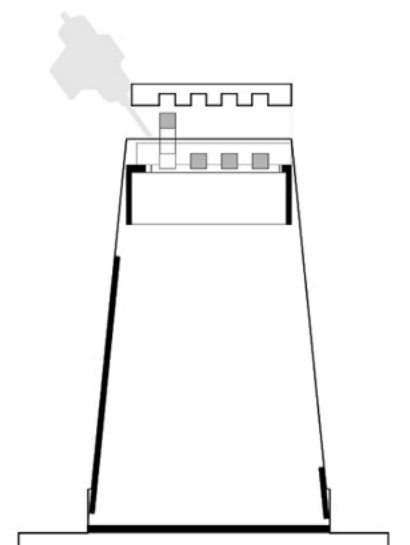

ROBOT SECOND GENERATION



06

**ESTERN WILDS:
HOTEL IN THE MOUNTAIN**
3ds Max rendering

Team partner | Lu Xu, Xinning Hua, Yining He
Techniques of the Ultrareal | Fall 2019
Instructor | Joseph Brennan, Philip Crupi
Individual Effort | Scheme design, 3ds Max, Phtot editing

This project focuses on using 3ds Max as the rendering tool to develop 3 detail-designed renders of a single building. The concept of this building is a town hotel seating in the mountain in south China. As our team wants to achieve a transition from traditional Chinese building style to modern architecture style, the right part of the building is more traditional which is built up with the white brick wall and black tiles roof. The left part of the building is more modern designed whose wall is made of all glass and steel columns. There is a corridor connects these two parts and a big pool in the middle of the courtyard.

Through this exercise, we not only able to grasp 3ds Max's application method as a rendering software but also have a change to design a Chinese style project which I did not get in touch with it before.