

The image shows the front cover of a book. The cover is a deep red color with a pebbled leather texture. A decorative gold border is embossed on the cover, consisting of a double-line rectangular frame with ornate, symmetrical scrollwork at each of the four corners. In the center of the cover, the word "escuela" is printed in a simple, lowercase, sans-serif font. Below it, the author's name "by: Christian Pineda" is printed in a smaller, italicized, lowercase, sans-serif font.

escuela
by: *Christian Pineda*

M.S. AAD GRADUATION PORTFOLIO CLASS OF 2020

CHRISTIAN PINEDA

The content of this portfolio showcases the work I produced over the past year at Columbia University's Graduate School of Architecture, Planning, and Preservation. I believe architecture school shows you how to solve socioeconomic, political, urban and infrastructure problems. The following is a presentation of a range of documentation that demonstrates my unique approach when solving these challenges. The work consists of a variety of urban, residential, mixed-use and adaptive re-use projects.

I want to thank all the professors and students who have contributed to my growth in so many ways. They have given me their time and treasured knowledge to help develop my vision and philosophy as an architectural student. Thank you.

pg. 1-40 **SUMMER**

pg. 41-82 **FALL**

pg. 83-122 **SPRING**

pg. 123-132 **VISUAL STUDIES**

pg. 133-142 **BUILDING SCIENCE AND TECHNOLOGY**

pg. 143-150 **HISTORY & THEORY**

THE SKYSCRAPER STUDIO

Prof. Dan Wood and Maurizio Bianchi Mattioli

ADAPATIVE RE-MODULATION

Prof. Kim Yao and Mark Rakatansky

THE MAKERGRAPH STUDIO

Prof. Ada Tolla, Giuseppe Lignano, Reza Zia and Thomas Demonchaux

TECHNIQUES OF THE ULTRA REAL

Prof. Joseph Brennan and Phillip Crupi

MODULAR ANATOMY

Prof. Andreas Tjeldflaat

LE CORBUSIER

Prof. Kenneth Frampton

THE SKYSCRAPER STUDIO

Prof. Dan Wood and Maurizio Bianchi Mattioli



This skyscraper celebrates diversity through spatial form. Skyscraper developers and designers are realizing the importance of creating a diverse environment capable of housing different types of programs to improve the quality of life. The market demands constant change, so buildings should adapt alongside it to better serve its inhabitants' demands. The project aims to house a mixed-use program that consists of the following: a public playground, a school, a library, a sports center, office spaces, and a hotel. An important element is public access. Integrating the public as much as possible to successfully develop a strong sustainable community is a must. This skyscraper offers an opportunity for the public to enjoy its verticality and city views by going up and down along a vertical observatory that is supported through a series of elevators, ramps, and platforms.

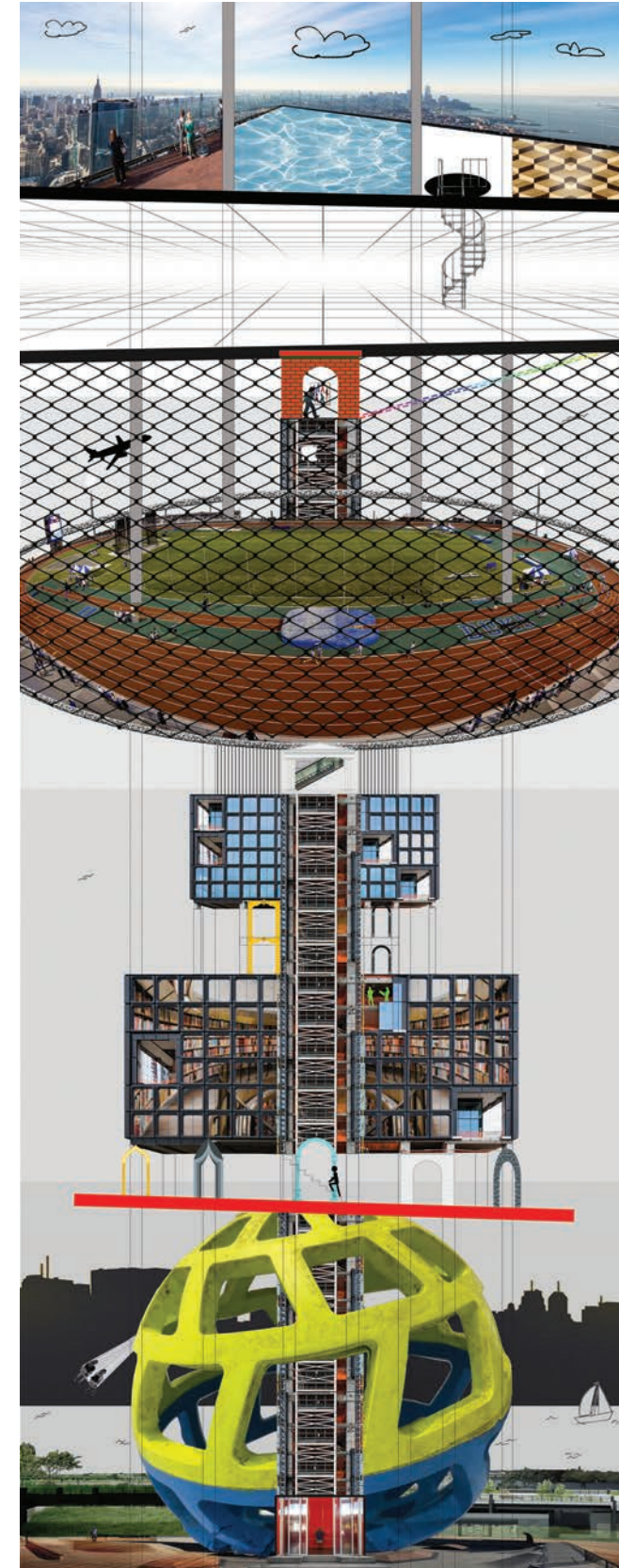

Program Analysis

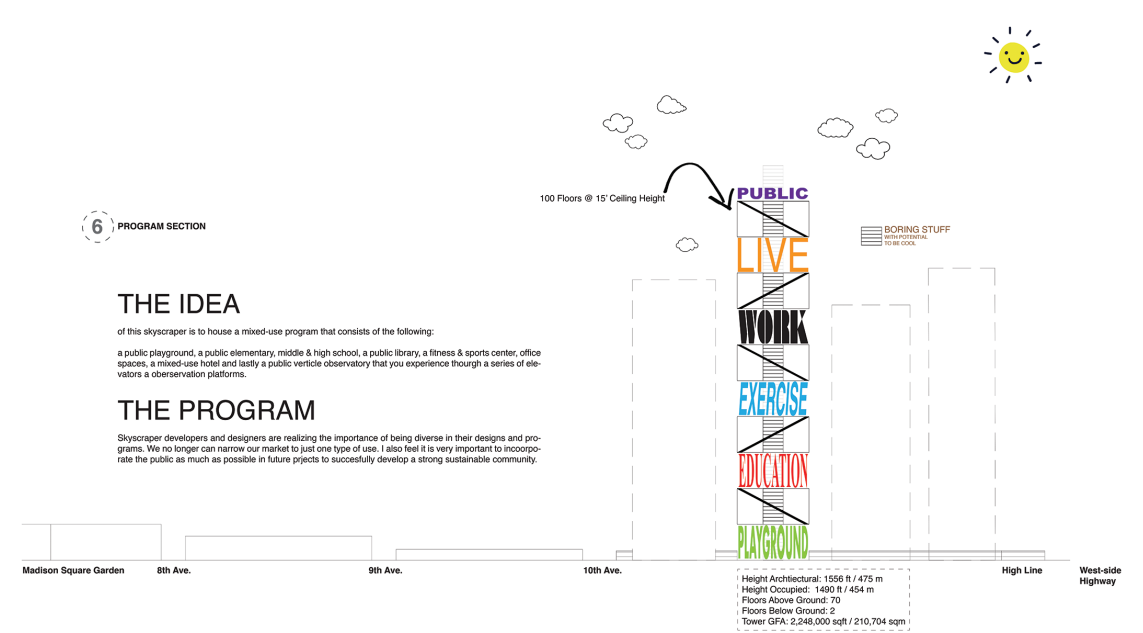
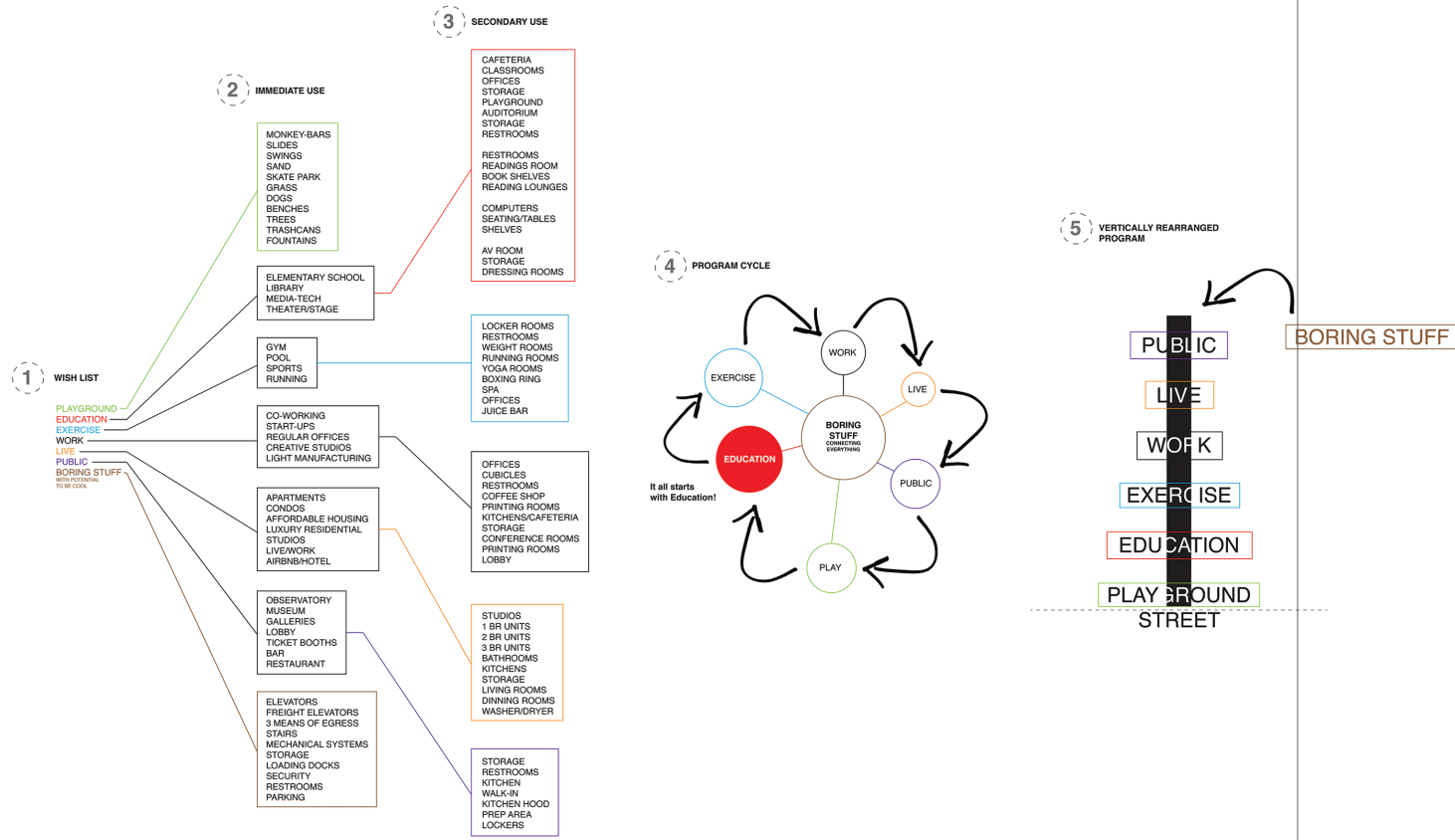

THE IDEA

of this skyscraper is to house a mixed-use program that consists of the following: a public playground, a public elementary, middle & high school, a public library, a fitness & sports center, office spaces, a mixed-use hotel and lastly a public vehicle observatory that you experience through a series of elevators a observervation platforms.

THE PROGRAM

Skyscraper developers and designers are realizing the importance of being diverse in their designs and programs. We no longer can narrow our market to just one type of uses. I also feel it is very important to incorporate the public as much as possible in future projects to successfully develop a strong sustainable community.

55 HUDSON YARDS

LOT SIZE: 82,373 sqft = 7,652 m²

CURRENT PROJECT HEIGHT: 776ft = 237m / 51 stories

KPF ARCHITECTS (BUILDING FOOTPRINT: 37,682 sqft = 3,500 m²)

• CORE SIZE: 8422 sqft = 782 m²

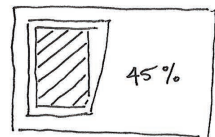

LOT vs BUILDING

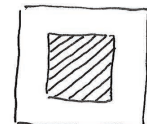

FLOOR PLATE vs CORE

MY PROPOSAL (BUILDING FOOTPRINT: 32,400 sqft = 3,010 m²)

• CORE SIZE:

IDEALLY 20% = 6,480 sqft

MEDIUM 22% = 7,128 sqft

CONSERVATIVE 25% = 8,100 sqft

BORING STUFF
WITH POTENTIAL TO BE COOL!

- FREIGHT ELEVATORS
- 3 MEANS OF EGRESS STAIRS
- MECHANICAL SYSTEMS
- STORAGE
- LOADING DOCKS
- SECURITY
- RESTROOMS
- PARKING

MECHANICAL SYSTEMS

- PLUMBING
- ELEVATORS
- ESCALATORS
- HEATING
- AIR-CONDITIONING
- WATER PUMPING SYSTEMS
- PRESSURE BOOSTING PUMPS SYSTEMS
- STORM & SEWAGE PUMP SYSTEMS
- ELEVATOR PIT VAULT SYSTEMS
- WATER HARVESTING PUMP SYSTEMS
- COOLING PUMP SYSTEM
- IRRIGATION PUMP SYSTEM
- STEAM CONDENSATE RETURN PUMP SYSTEM
- WATER HEATING & TEMPERATURE CONTROL SYSTEMS
- CHILLERS & COOLING TOWERS
- FANS & COMPRESSORS
- BOILERS
- LIGHTING CONTROLS
- GENERATORS
- HVAC AND SO ON...

CORE

- ELEVATOR
- ELEVATOR LOBBY
- SERVICE FREIGHT ELEVATOR
- FREIGHT ELEVATOR LOBBY
- 3 EMERGENCY STAIR EXITS
- RESTROOMS MEN & WOMAN
- MECHANICAL ROOM
- EMERGENCY MECHANICAL ROOM
- ELECTRICAL ROOM
- JANITORS CLOSET
- GENERAL CLOSET
- TRASH SHAFT
- IT ROOM

STRUCTURE?

SPLIT

CORE

- FREIGHT ELEVATOR LOBBY
- SERVICE FREIGHT ELEVATOR
- 2 EMERGENCY STAIR EXITS
- MECHANICAL ROOM
- EMERGENCY MECHANICAL ROOM
- ELECTRICAL ROOM
- TRASH SHAFT

- ELEVATOR LOBBY
- ELEVATOR
- 1 EMERGENCY STAIR EXITS
- RESTROOMS MEN & WOMAN
- ELECTRICAL ROOM
- JANITORS CLOSET
- GENERAL CLOSET
- IT ROOM

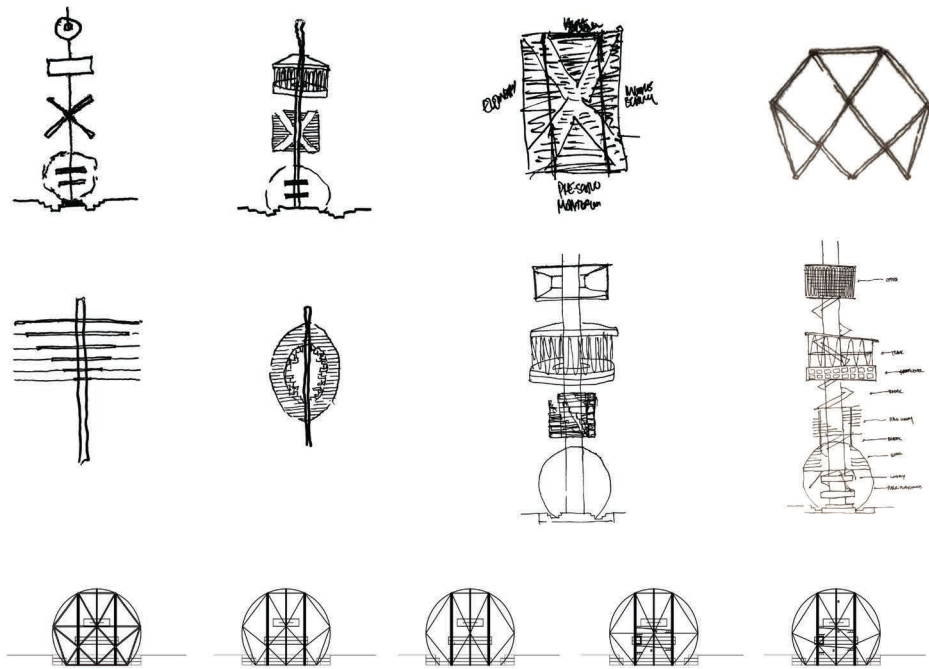

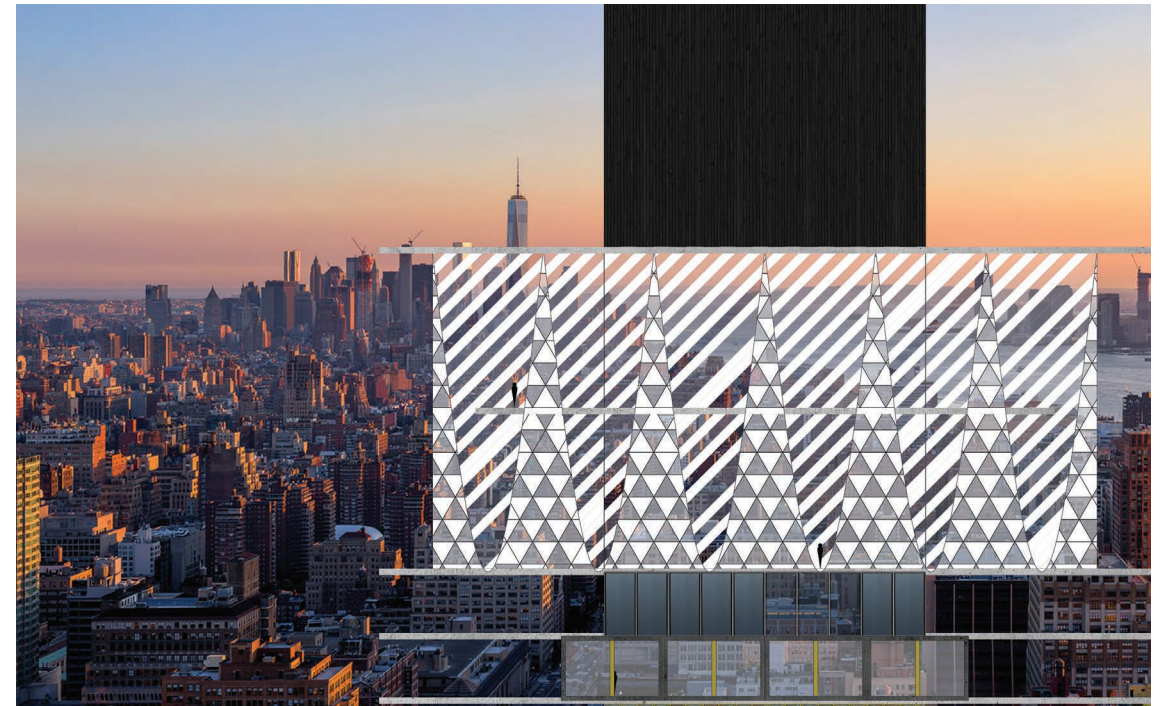

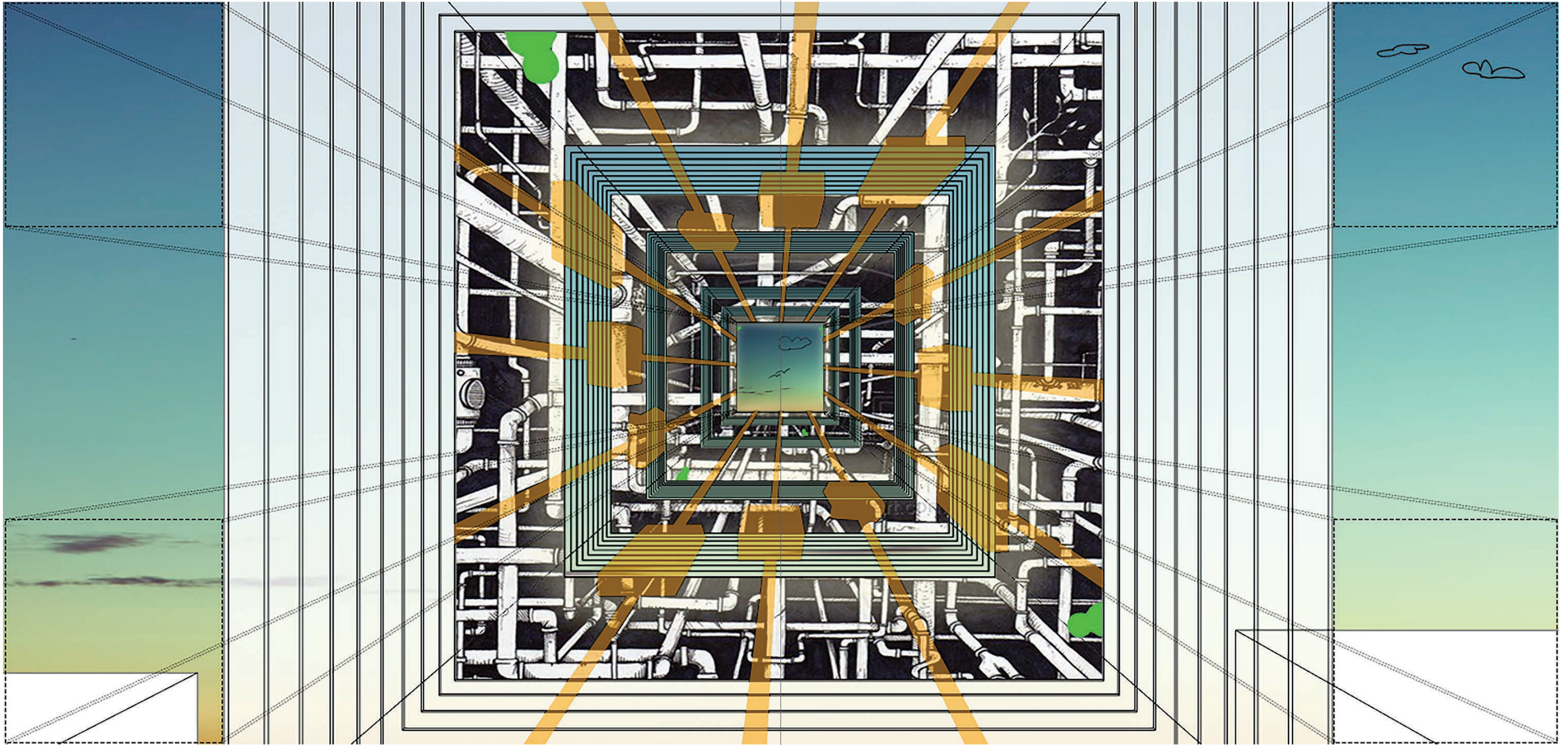

Floor Plate vs Core Ratio

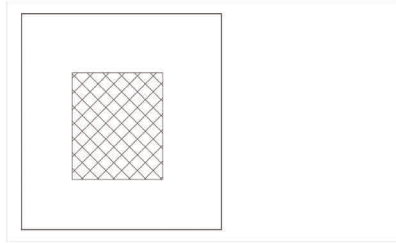

Floorplate: 37,682 sqft / Useable: 29,260 sqft
 Core: 8,422 sqft
 Floor Plate vs Core 22%

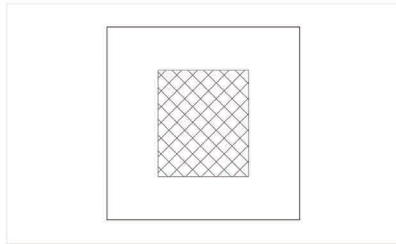

Floorplate: 32,400 sqft / Useable: 23,978 sqft
 Core: 8,422 sqft
 Floor Plate vs Core 25% / 35%

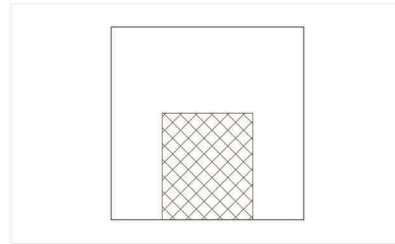

Floorplate: 32,400 sqft / Useable: 23,978 sqft
 Core: 8,422 sqft
 Floor Plate vs Core 25% / 35%

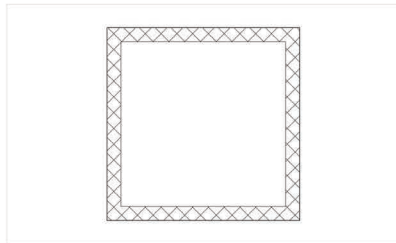

Floorplate: 32,400 sqft / Useable: 23,716 sqft
 Core: 8,684 sqft
 Floor Plate vs Core 26% / 36%

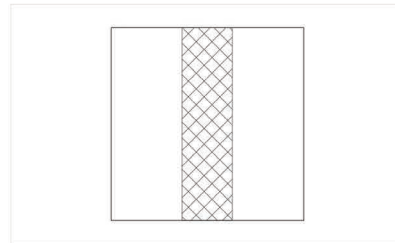

Floorplate: 32,400 sqft / Useable: 23,806 sqft
 Core: 8,460 sqft
 Floor Plate vs Core 26% / 35%

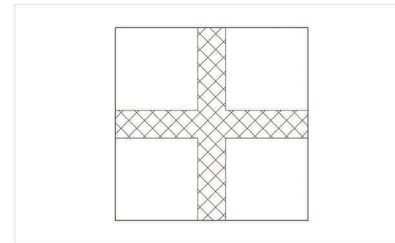

Floorplate: 32,400 sqft / Useable: 23,716 sqft
 Core: 8,684 sqft
 Floor Plate vs Core 26% / 36%

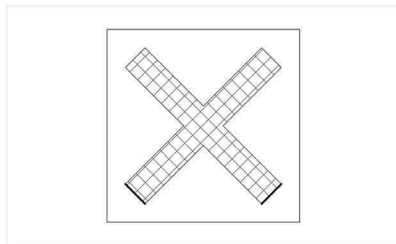

Floorplate: 32,400 sqft / Useable: 23,716 sqft
 Core: 8,684 sqft
 Floor Plate vs Core 26% / 36%

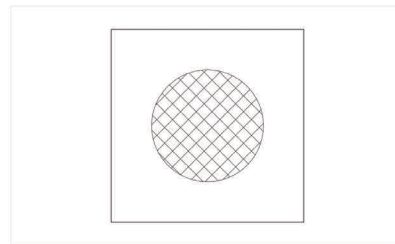

Floorplate: 32,400 sqft / Useable: 23,823 sqft
 Core: 8,577 sqft
 Floor Plate vs Core 26% / 36%

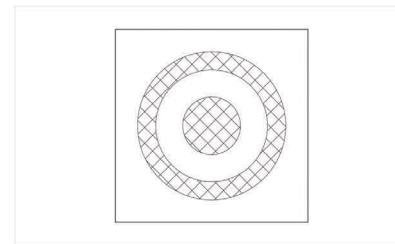

Floorplate: 32,400 sqft / Useable: 23,667 sqft
 Core: 8,733 sqft
 Floor Plate vs Core 27% / 37%

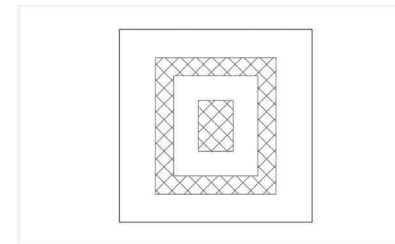

Floorplate: 32,400 sqft / Useable: 23,849 sqft
 Core: 8,560 sqft
 Floor Plate vs Core 26% / 36%

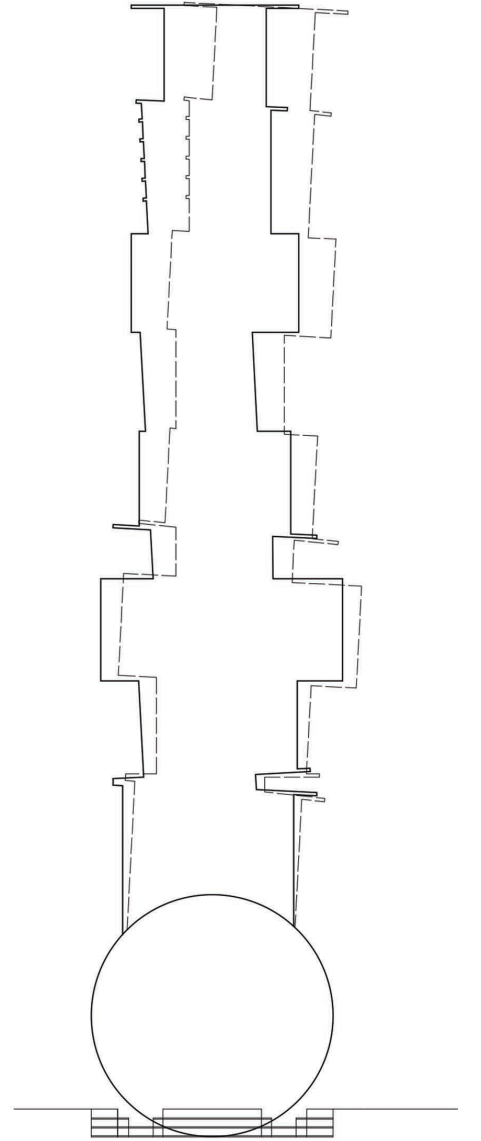
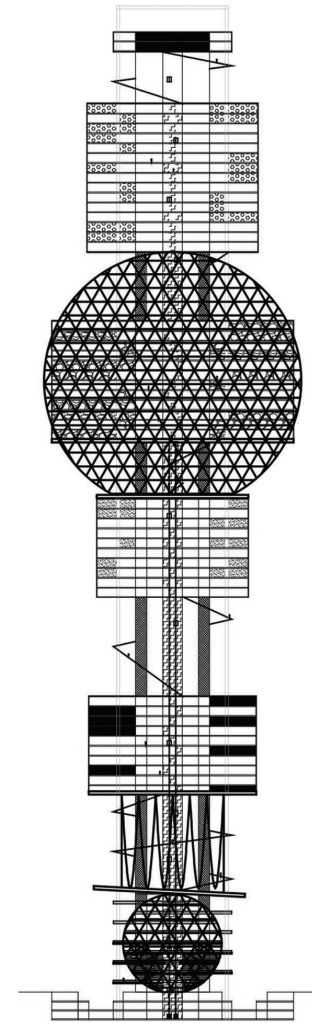
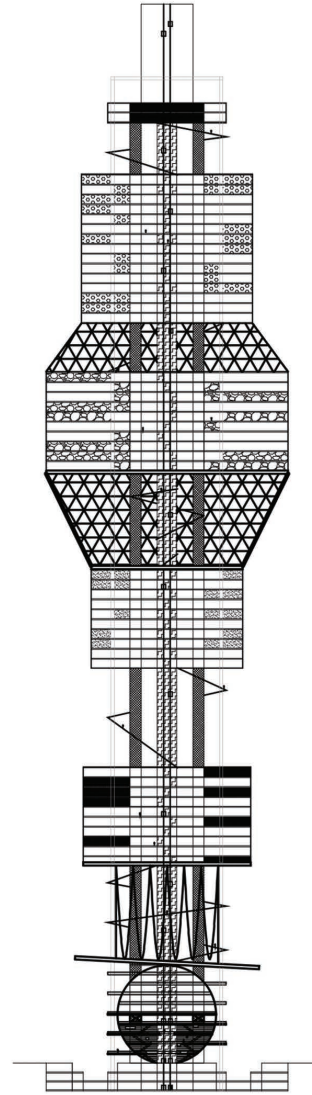
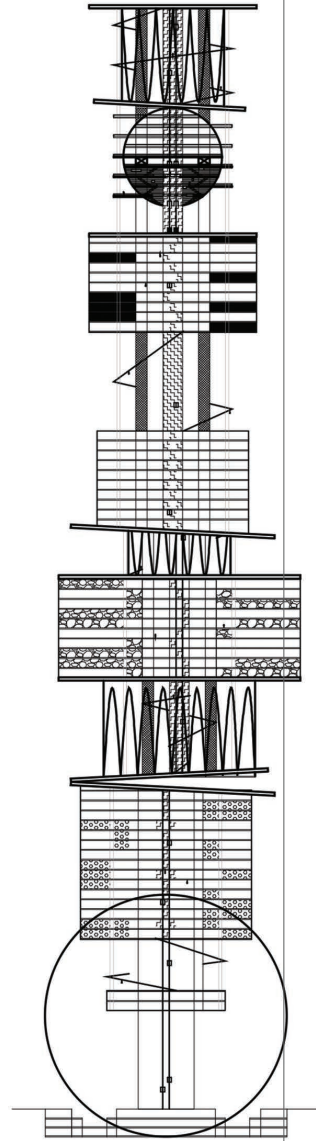
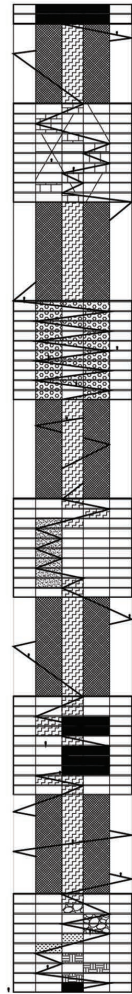
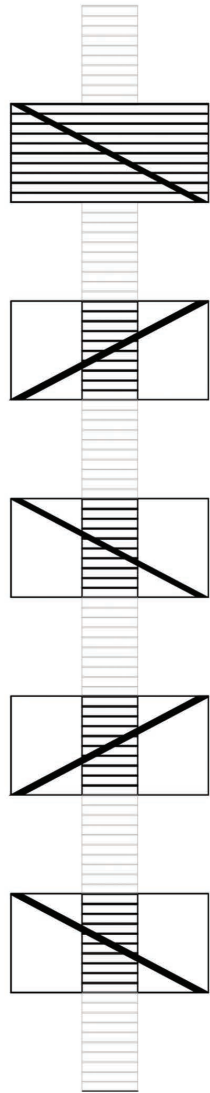

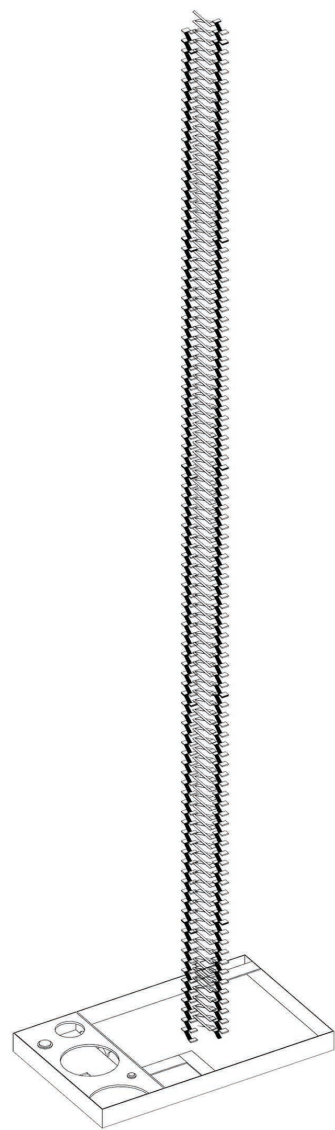

Emergency Stairs

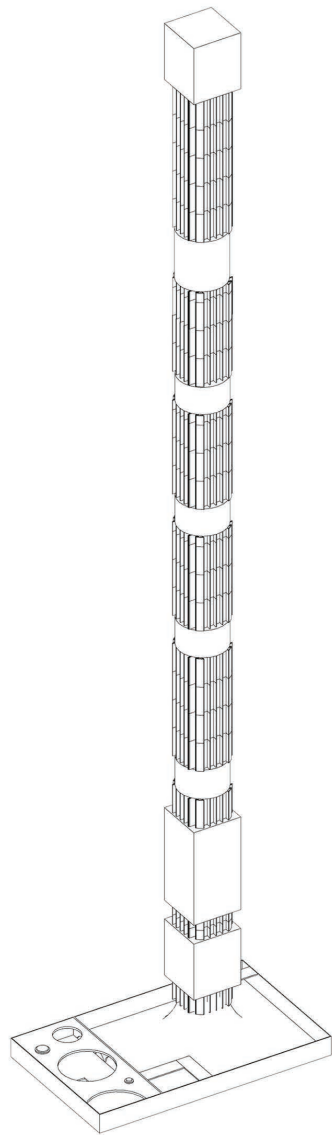

Mechanical Shaft

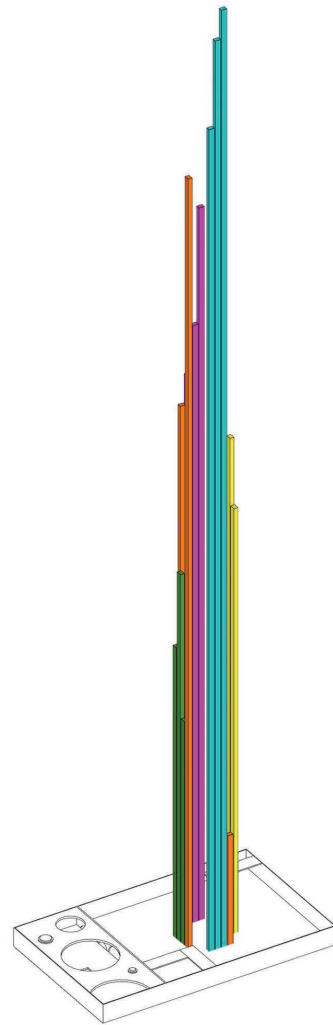

Elevators

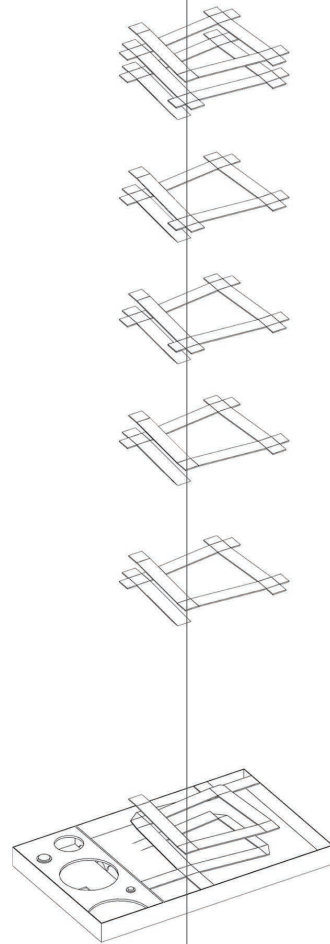

Pedestrian Ramp

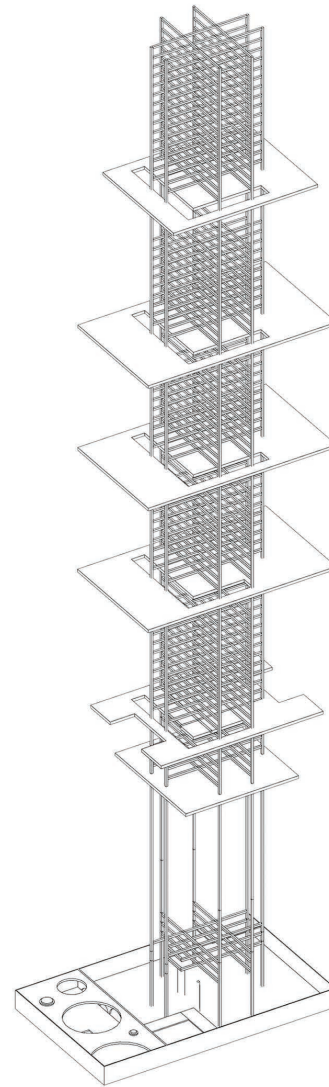

Structural System

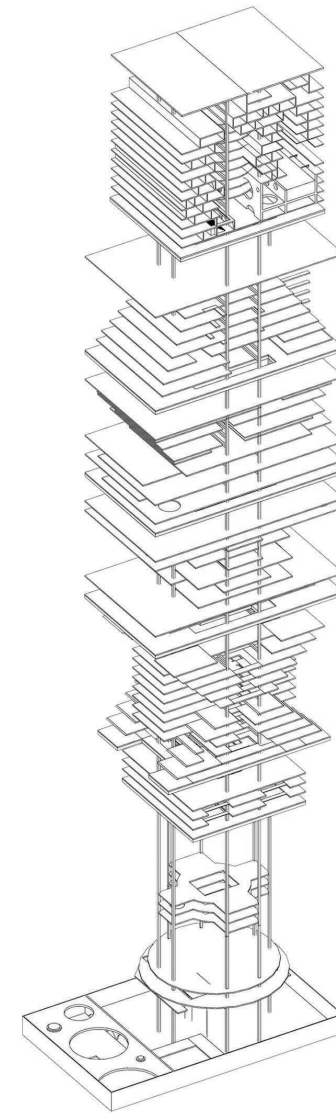

Floor Plates

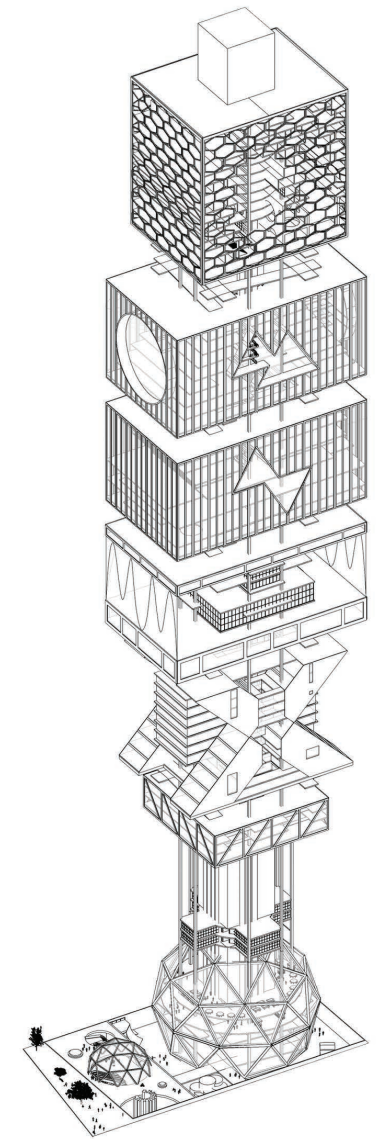

Proposal

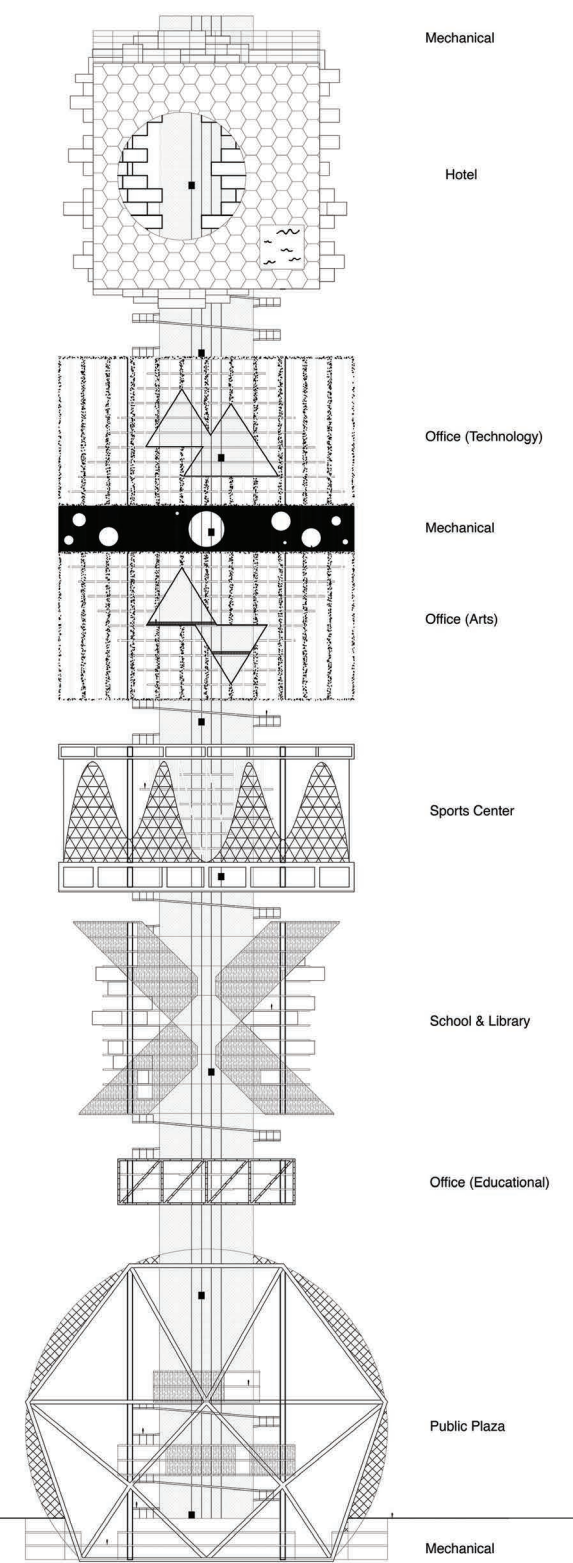
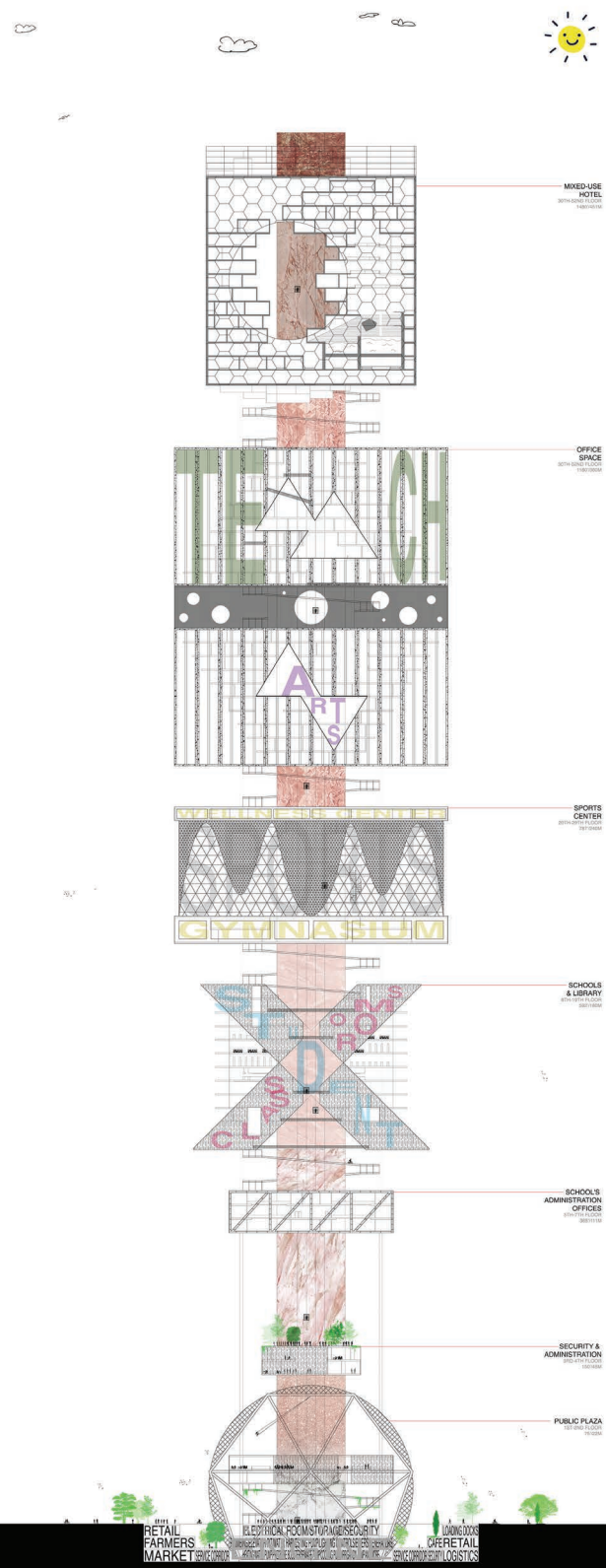

Section
1:500

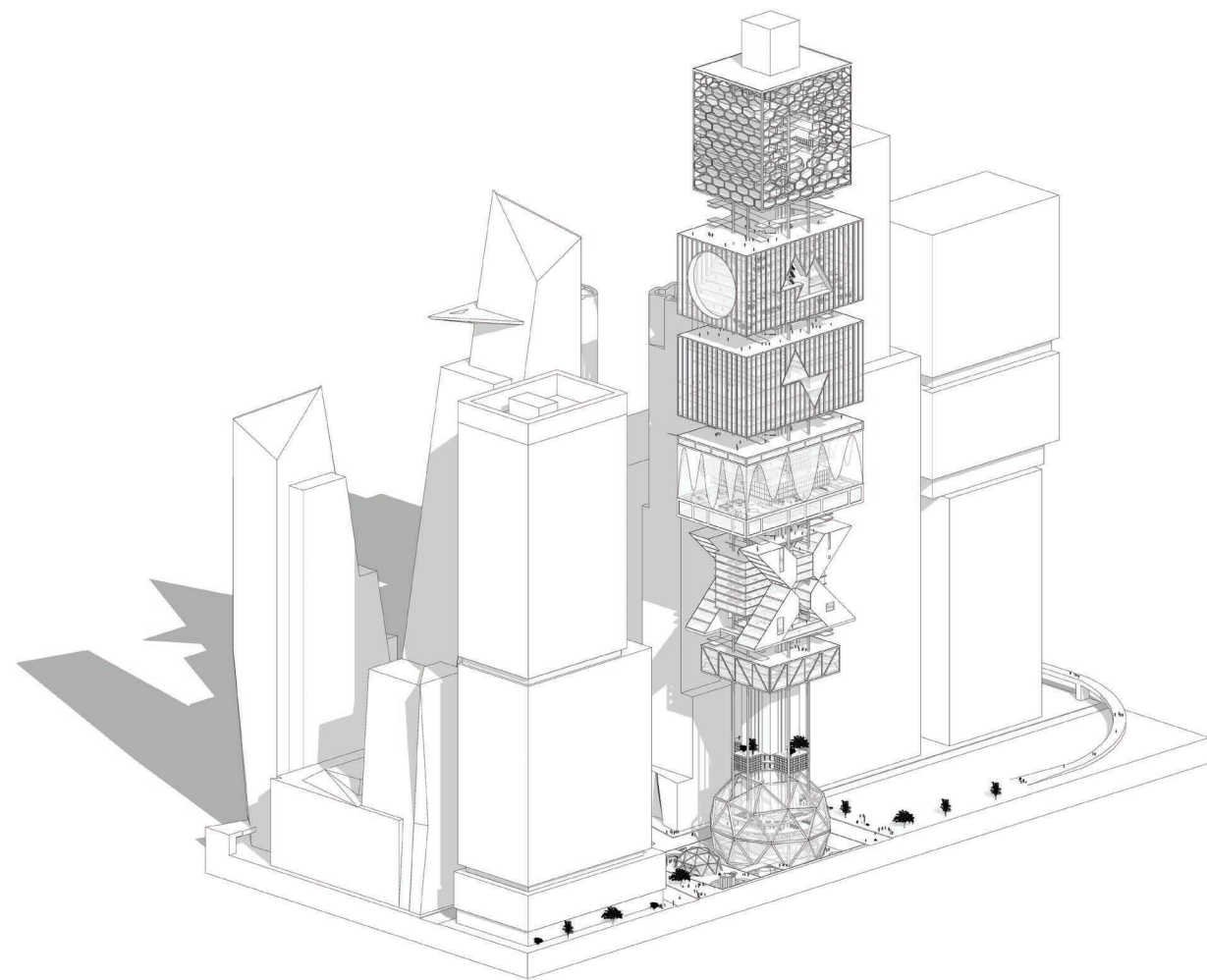
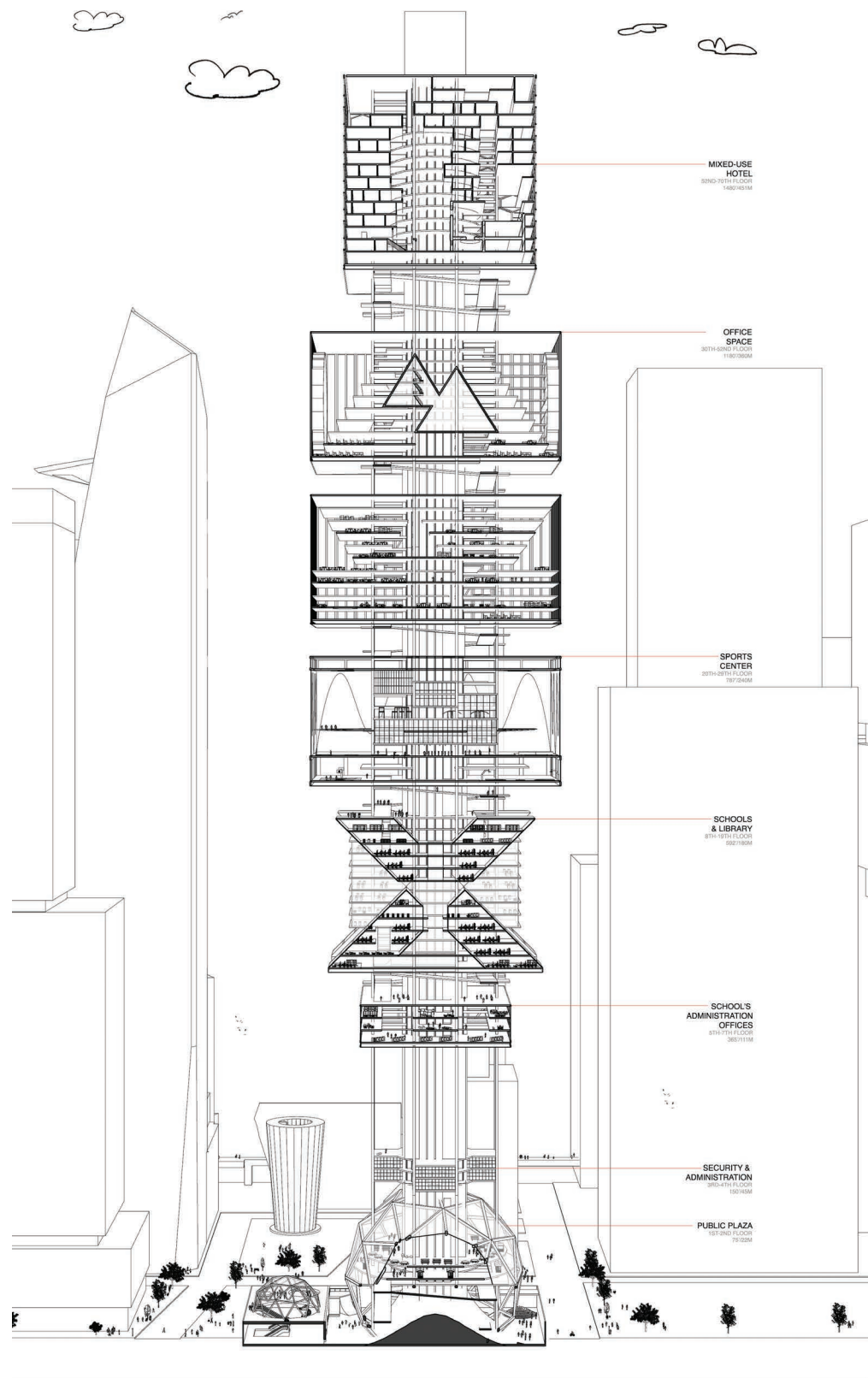

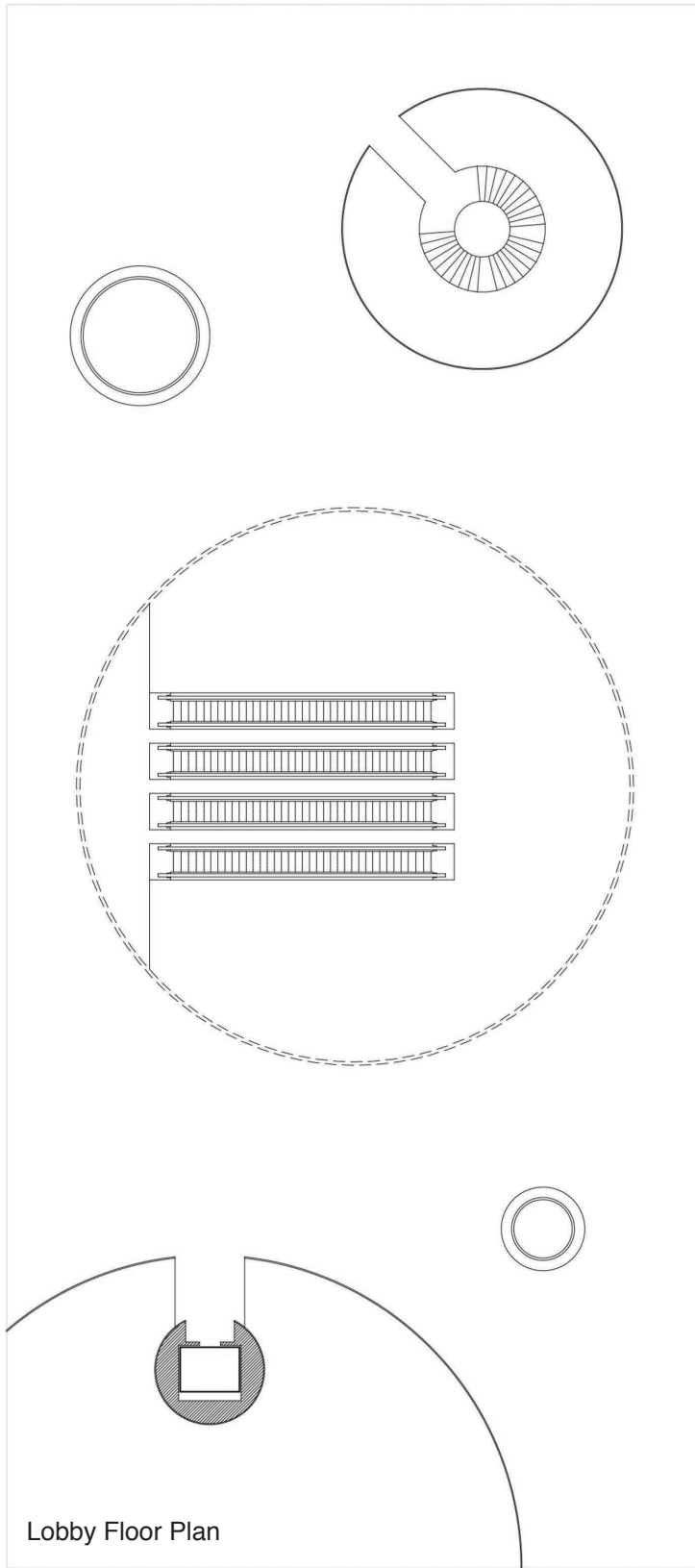

Lobby Floor Plan

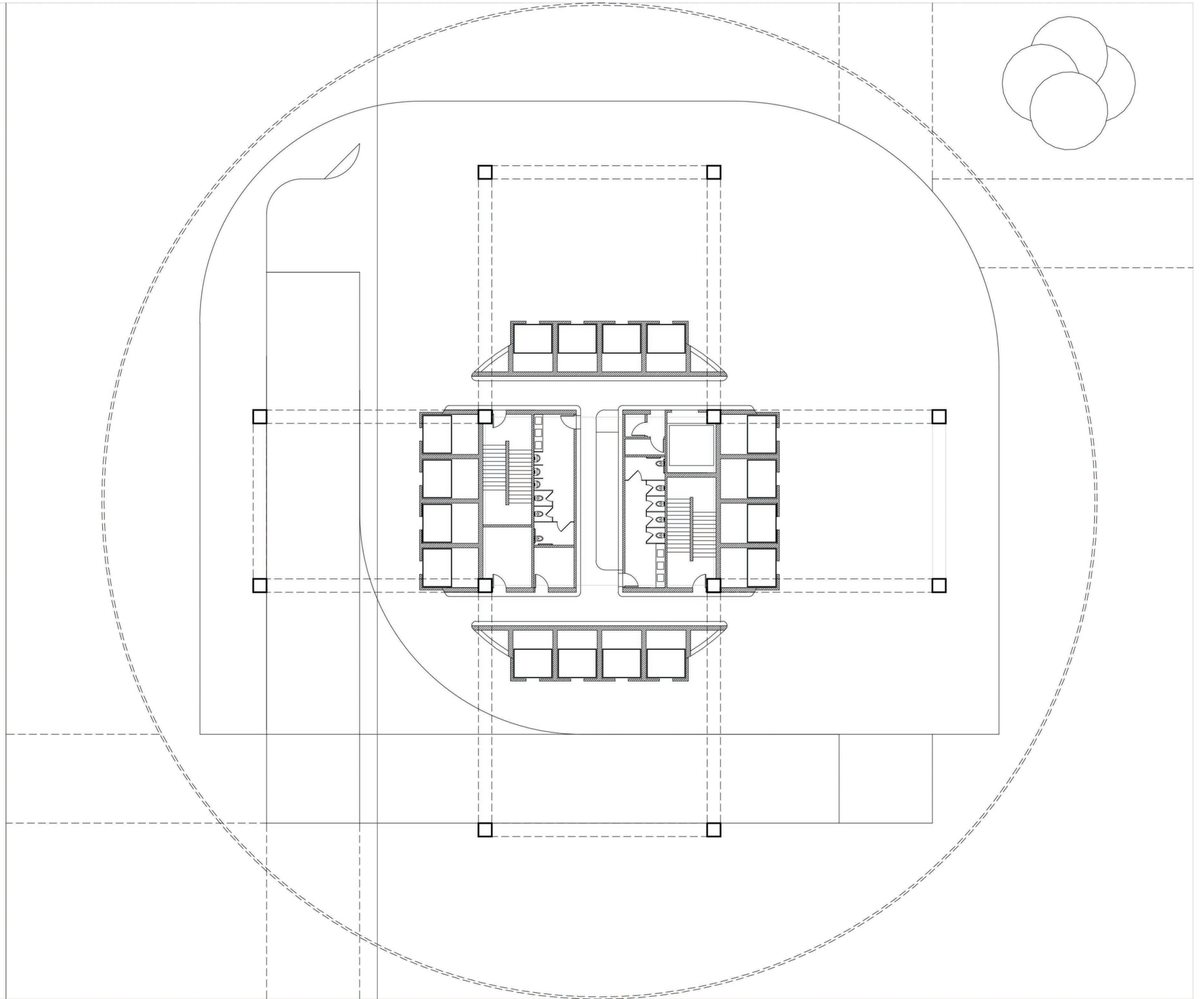

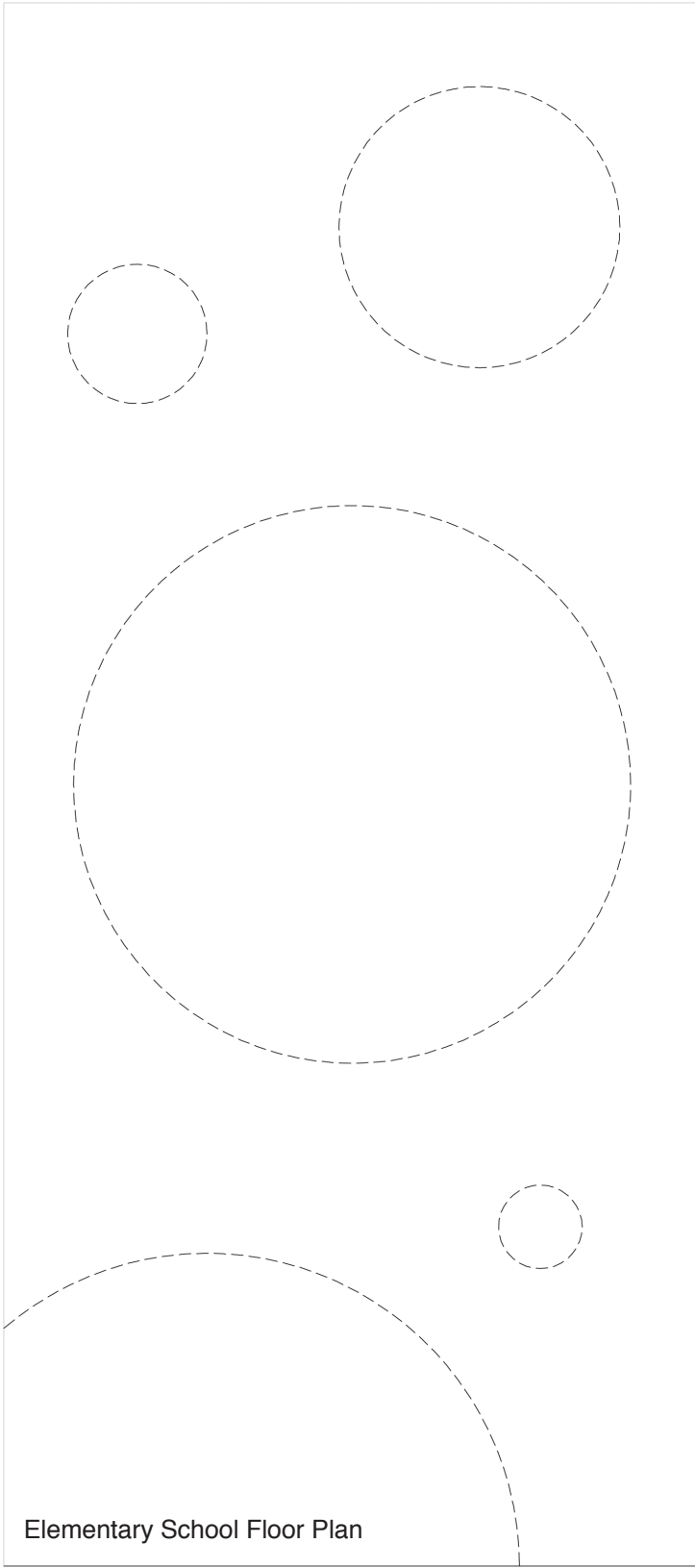

Elementary School Floor Plan

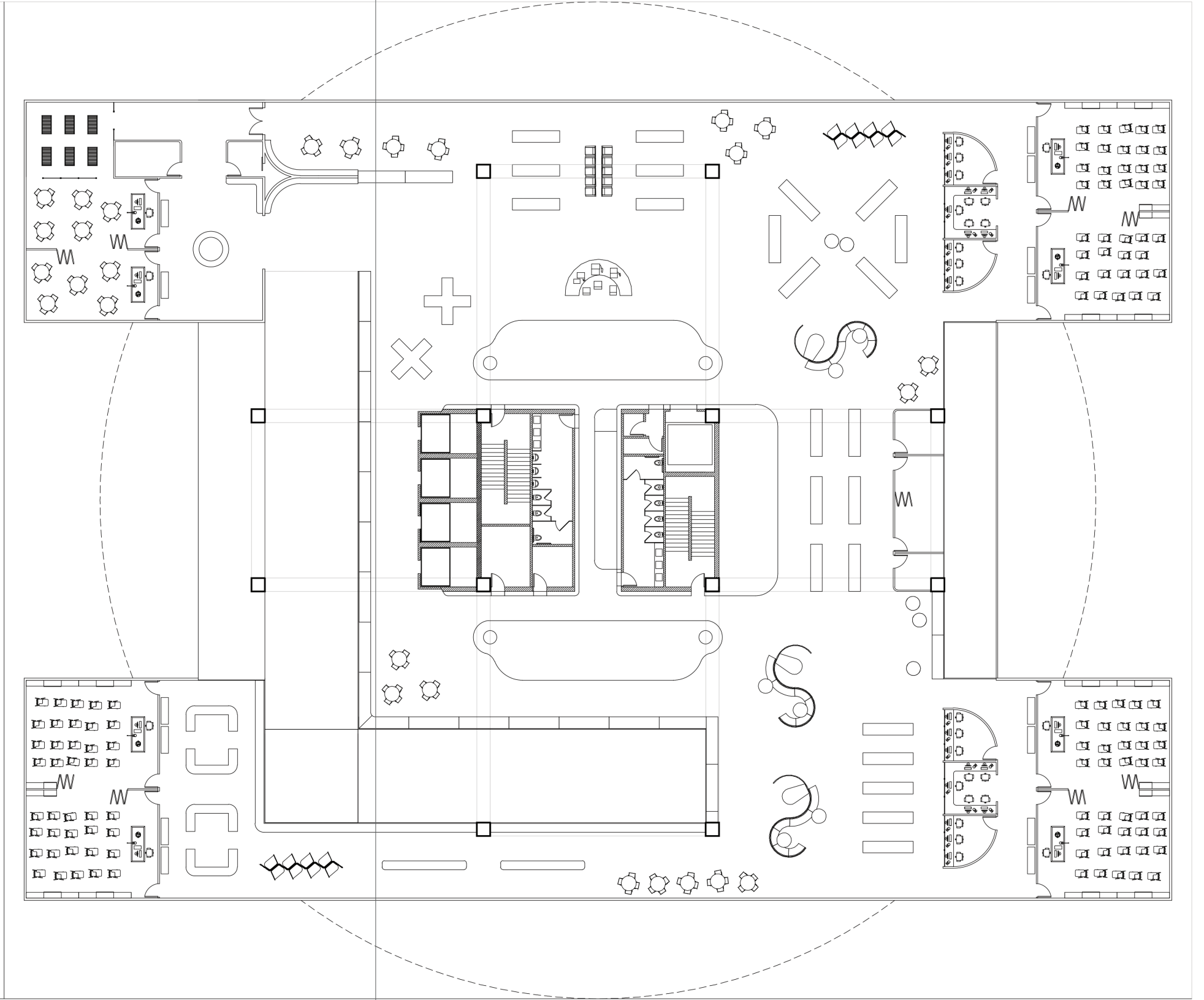

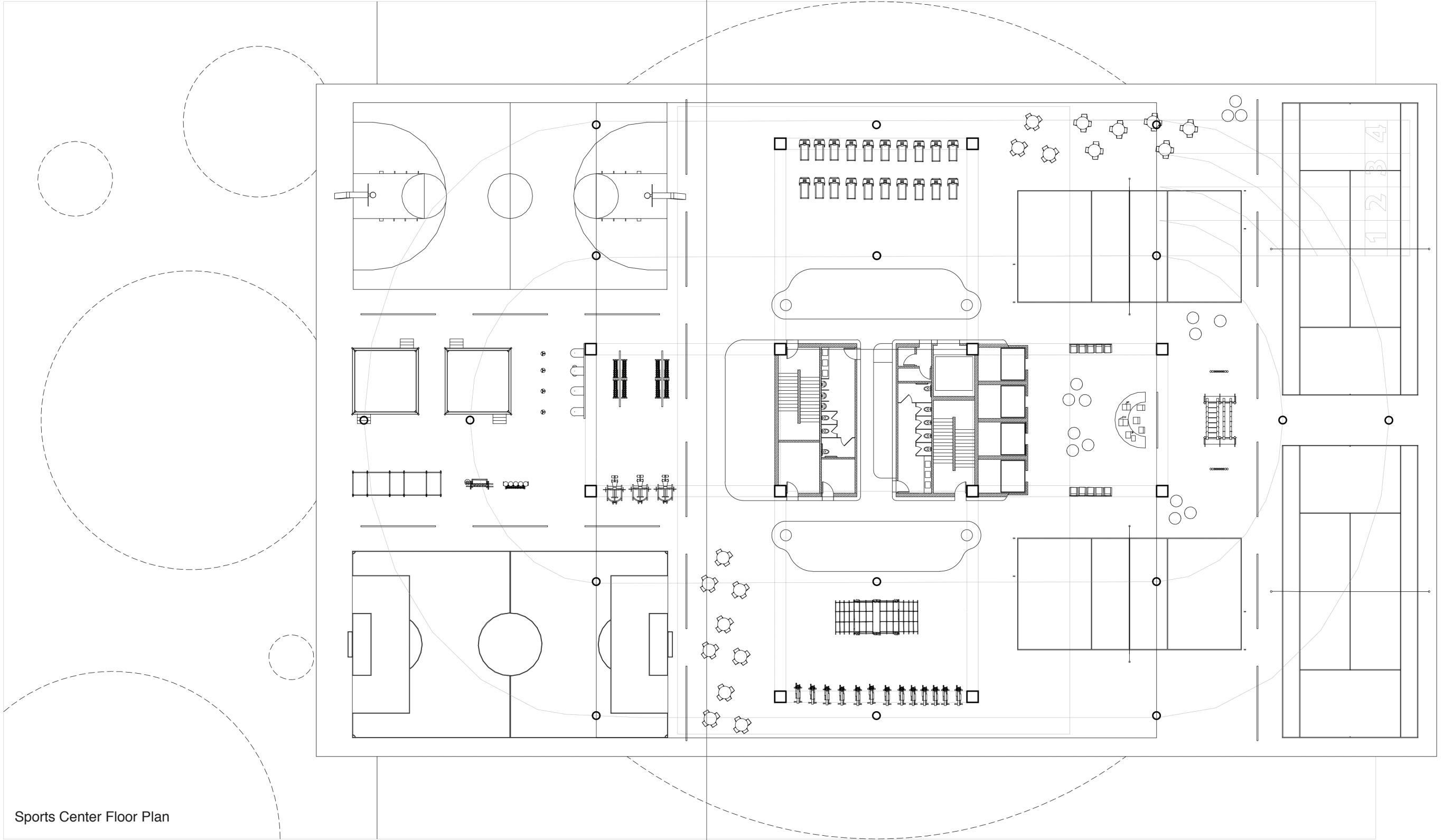

Sports Center Floor Plan

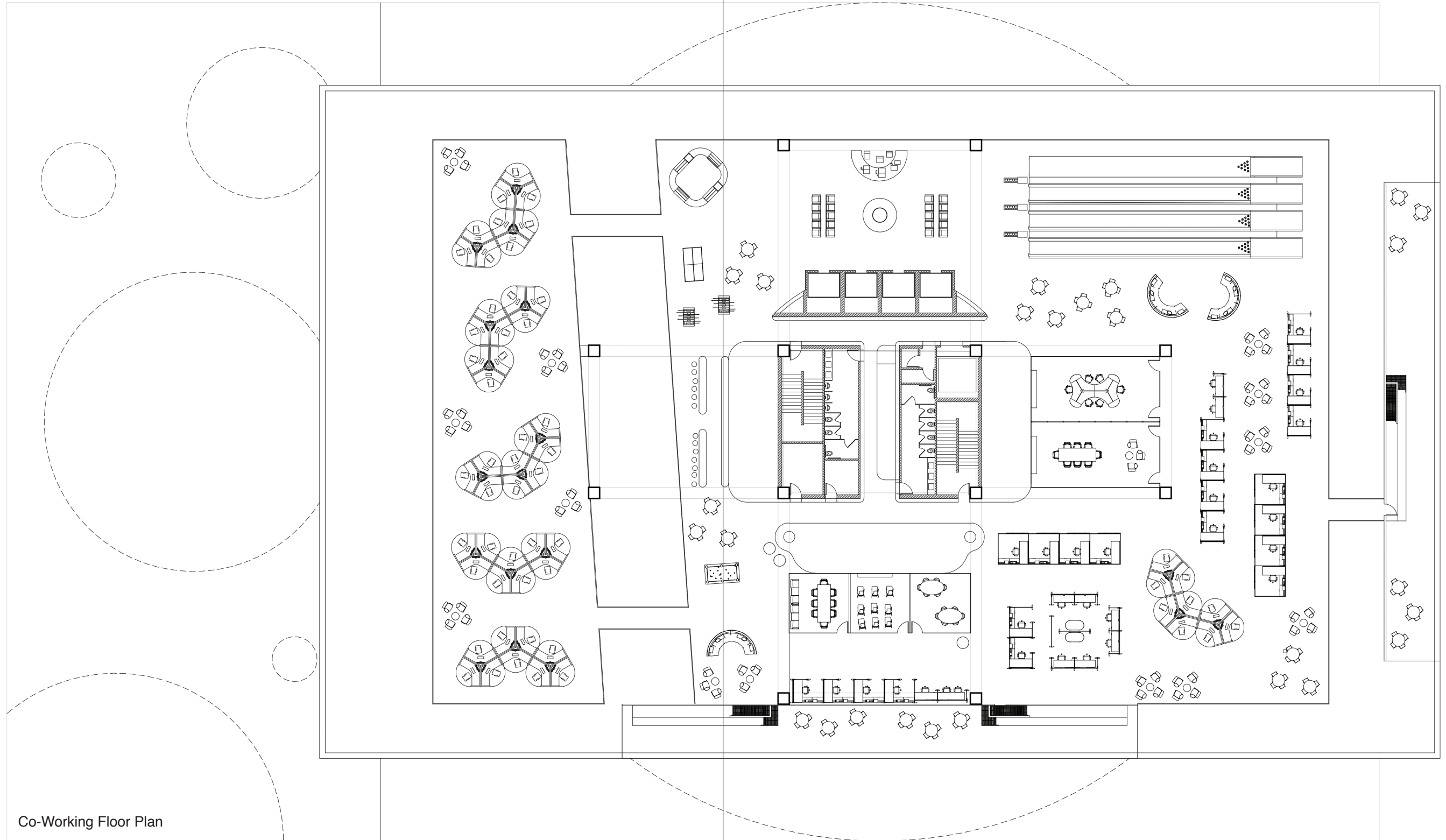

Co-Working Floor Plan

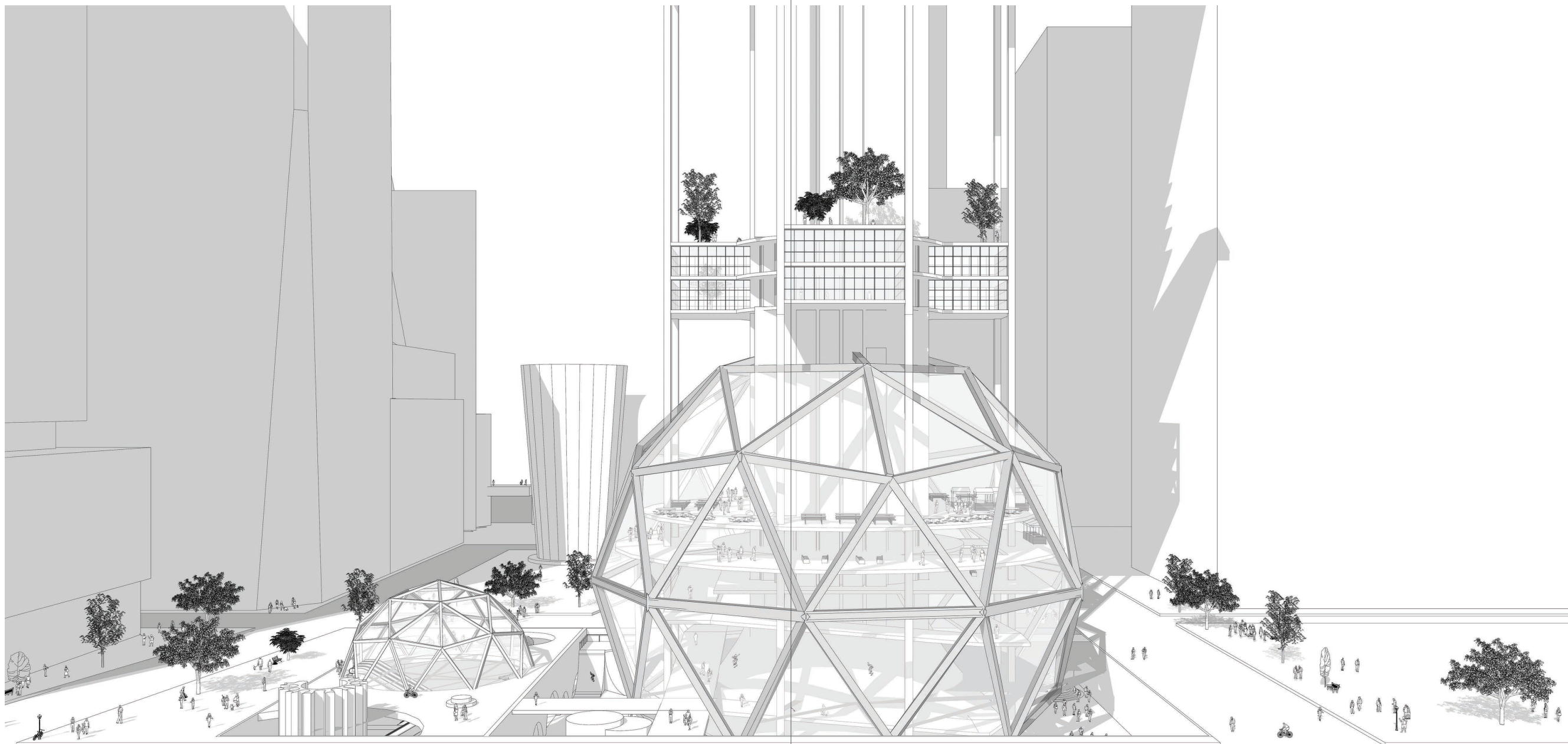

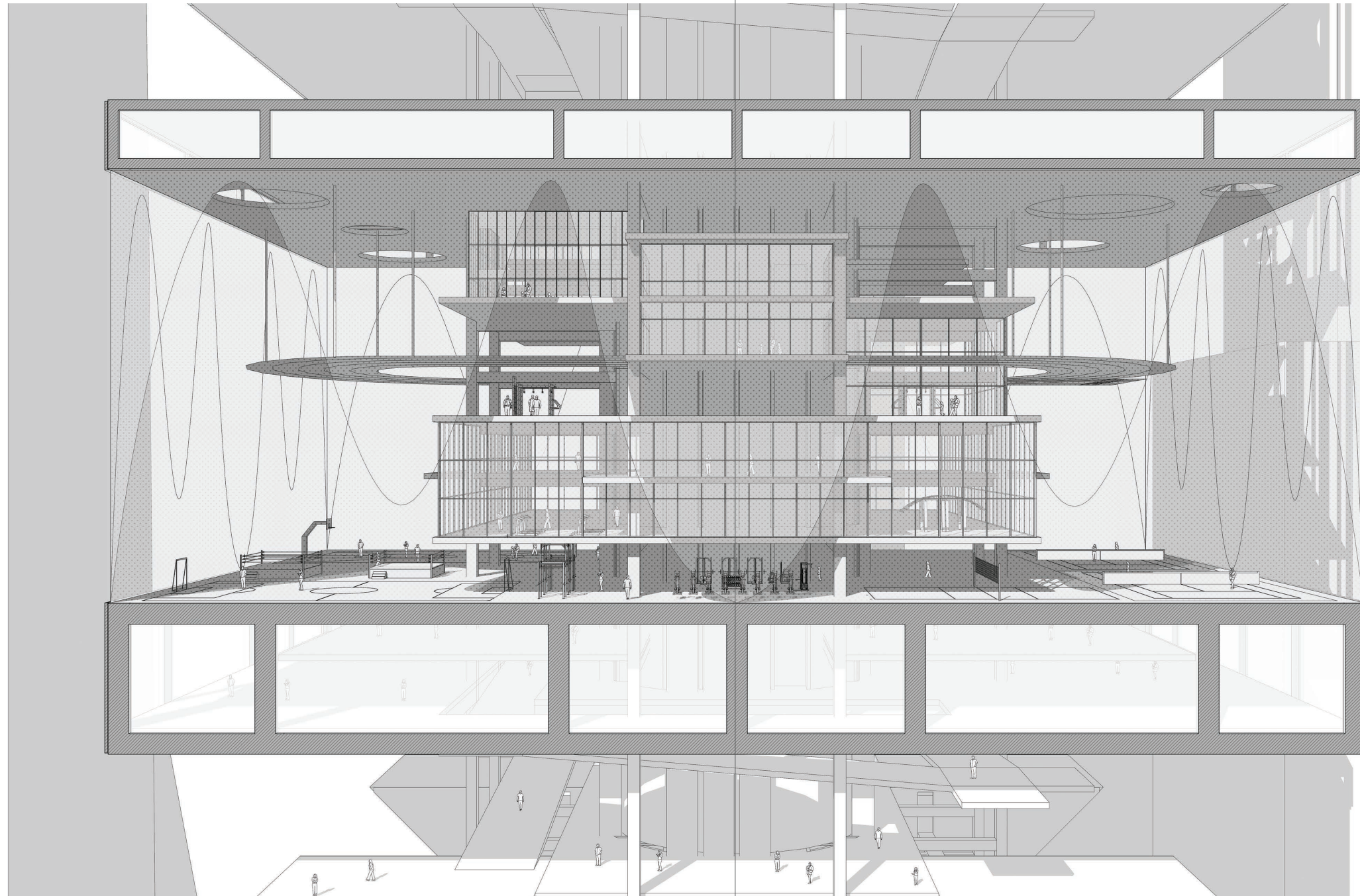

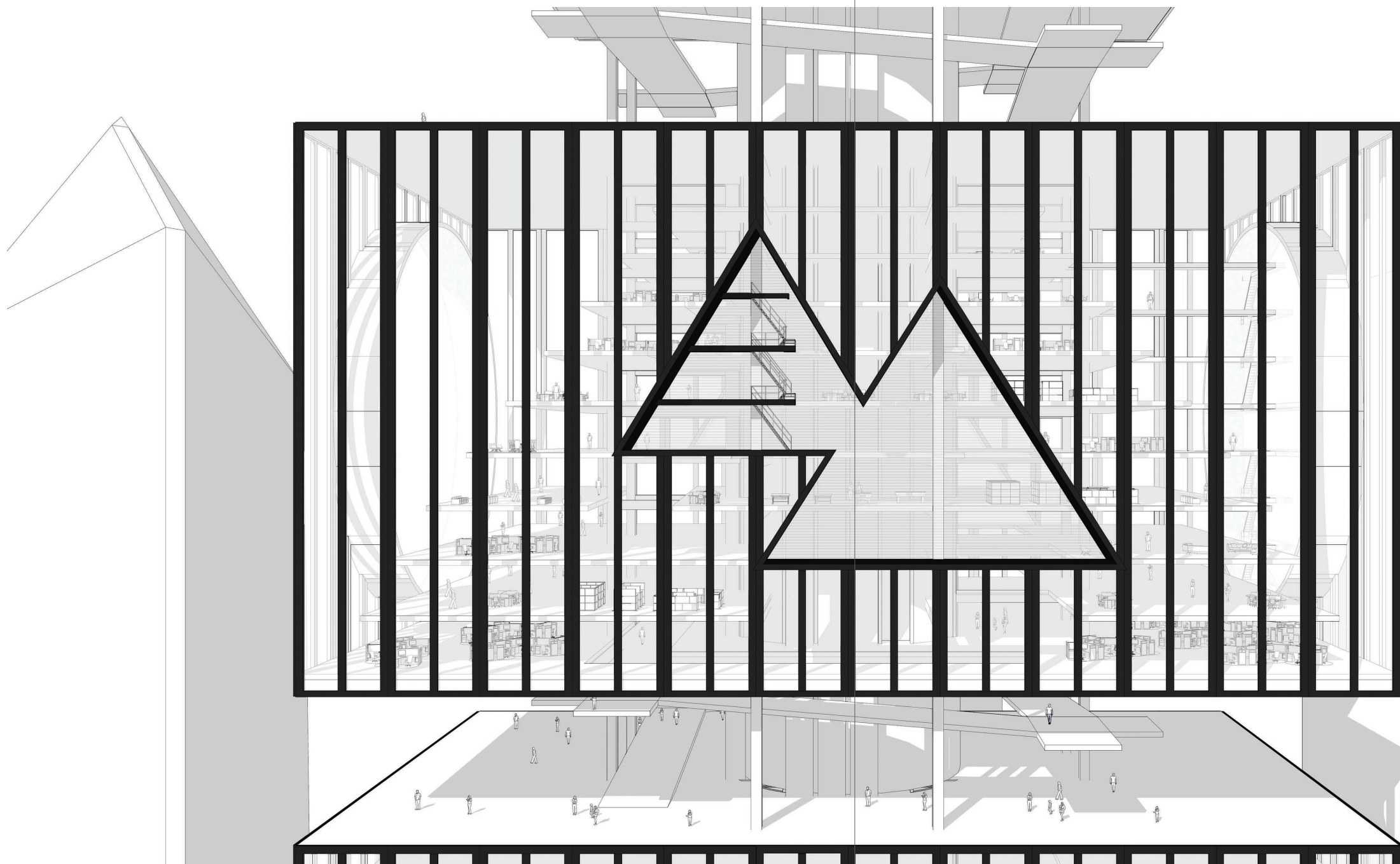



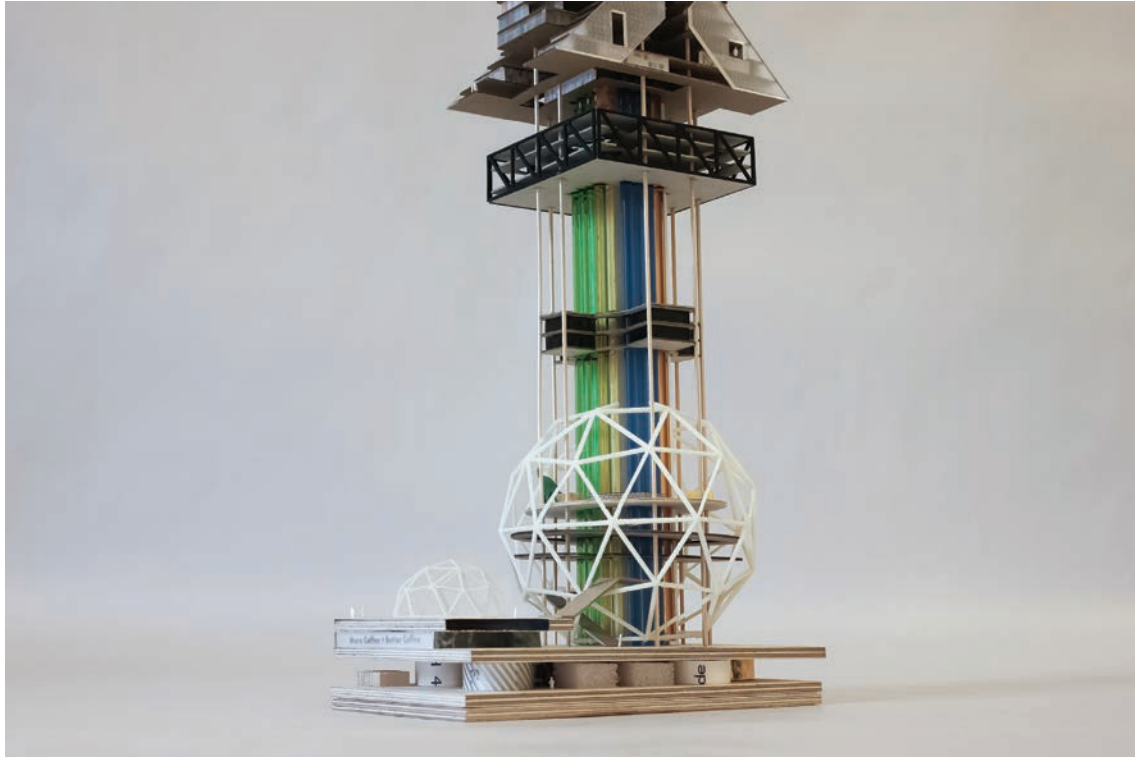

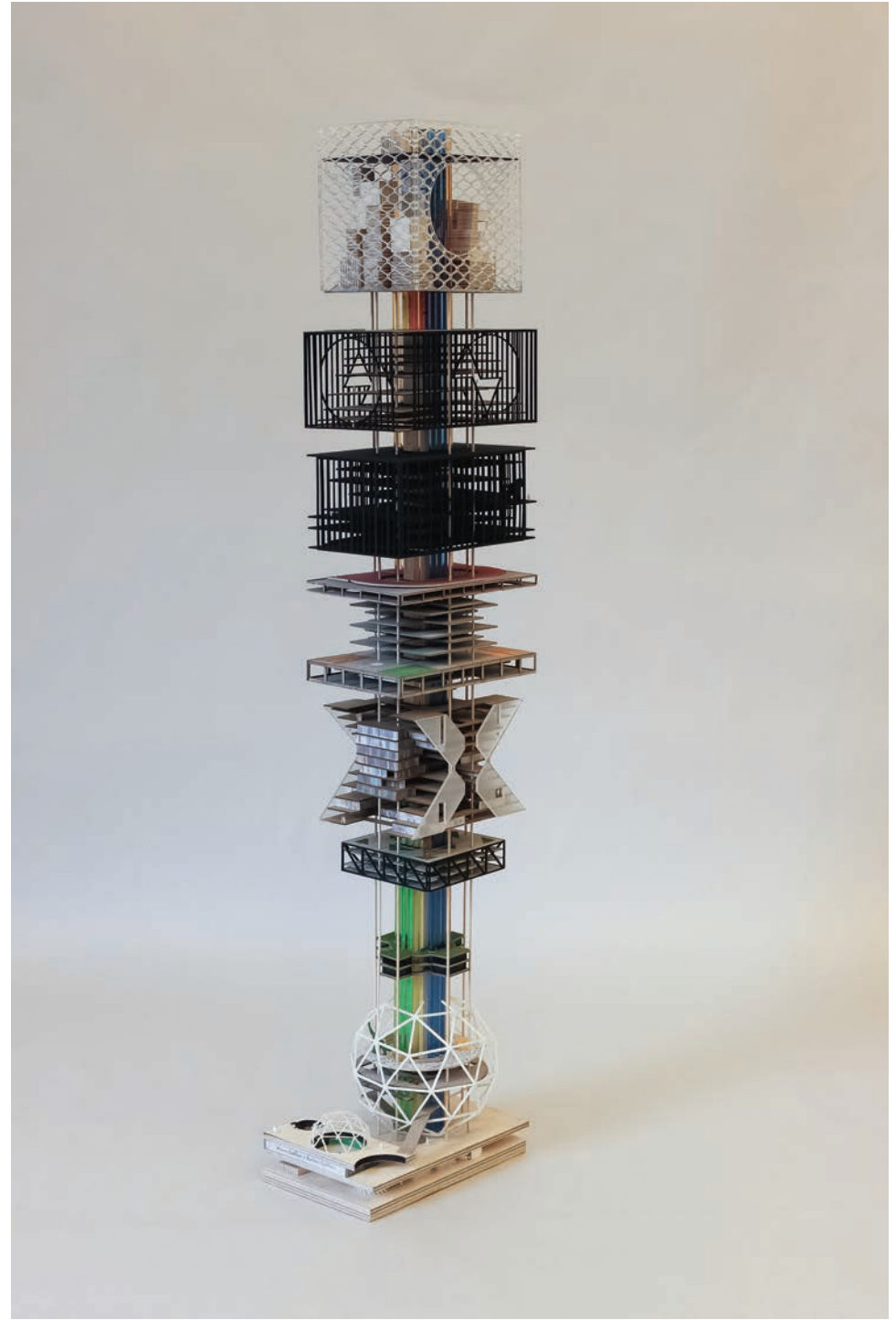

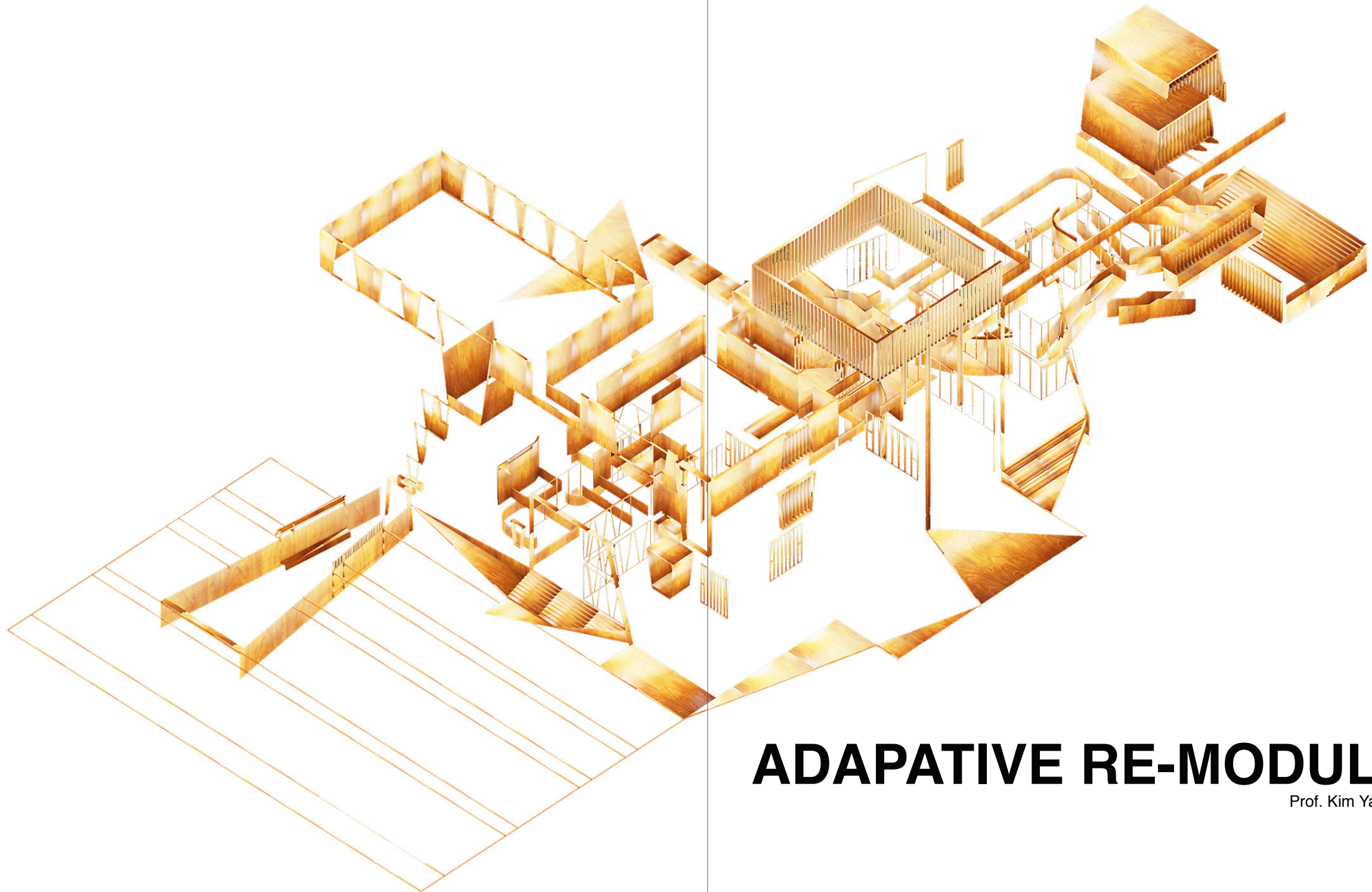

ADAPATIVE RE-MODULATION

Prof. Kim Yao and Mark Rakatansky

The following is an architectural intervention between Breuer, M.C. Escher and myself. Surprisingly, after visiting The Hague in the Neatherlands, I found out many locals dislike Breuer's building and what it represented in the past. Currently, the city is considering to house a hybrid between The MC Escher Museum and a 50-bedroom hotel. While the city makes up their mind, a local non-profit art center called West Den Haag is occupying the old Embassy. Breuer's main intention when designing the US Embassy was to achieve openness through materiality and glazed bridges. The idea of this project is to simply continue his approach, but rather than adding to the building, I am removing the unnecessary and preserving as much as possible to fully adapt the building to the program: a mixed-use village composed of a museum, hotel, West Den Haag art center, and an educational public plaza. In this new design, I am exploding the two heavy wings into four independent buildings and tying them together with a series of circulation bridges that house the Escher Museum. By doing this I am shifting part of the building's purpose towards public use so it can finally represent and celebrate local and international culture.



M.C. Escher - Reptiles

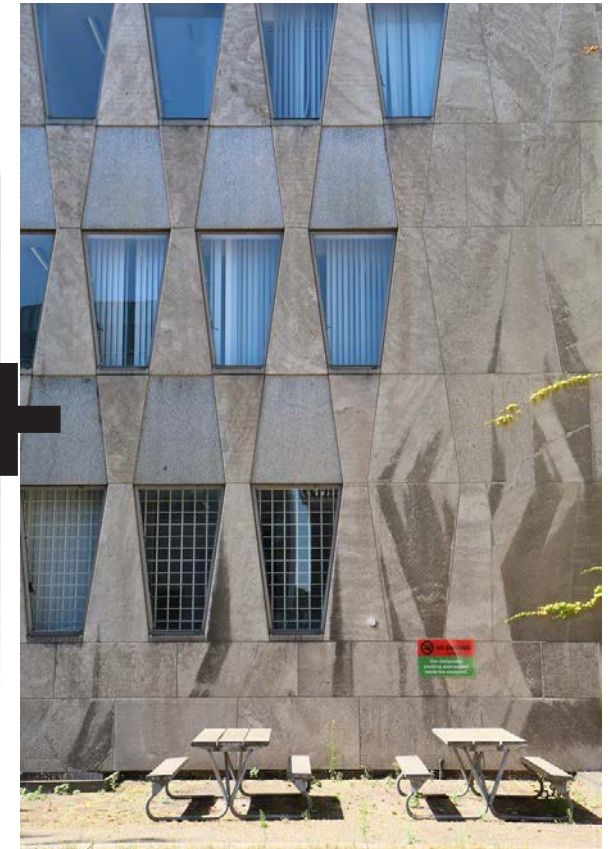

Marcel Breuer - U.S. Embassy, The Hauge

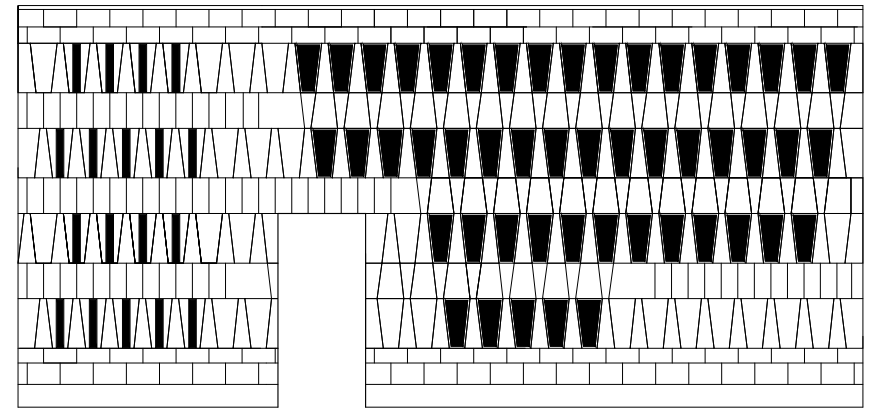
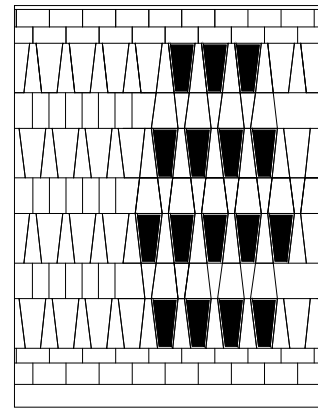
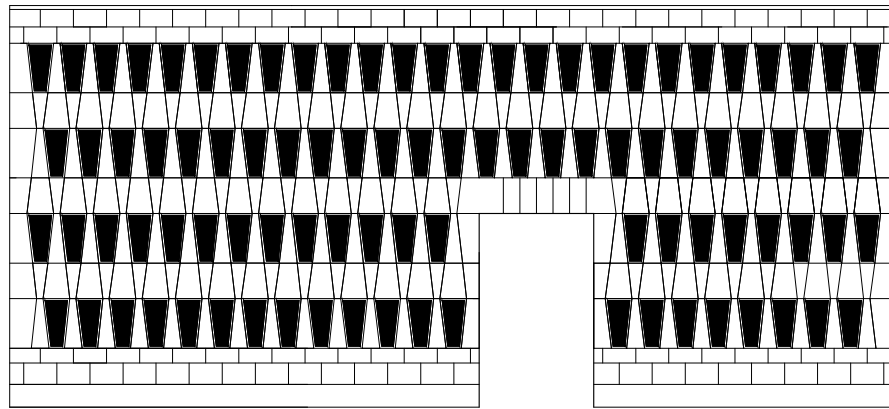

WINDOWS

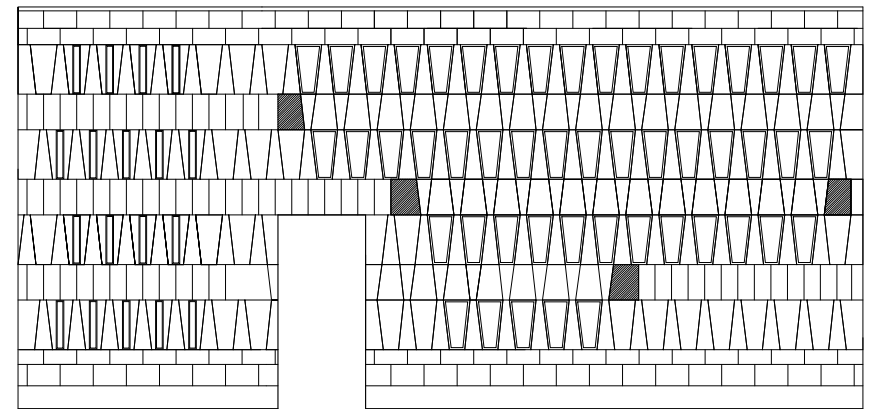
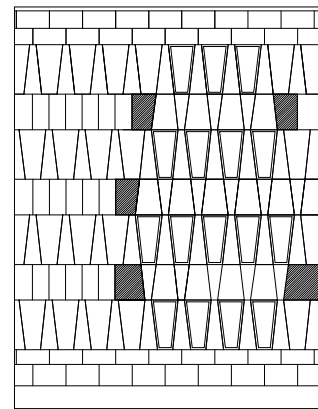
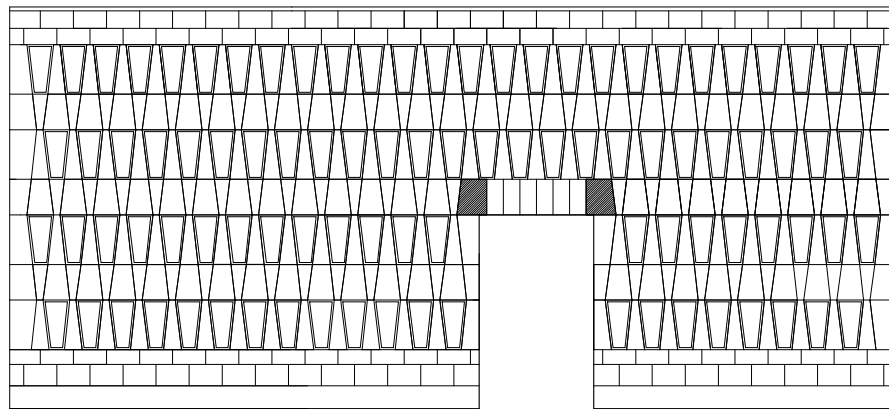

TRANSITIONAL SHAPES

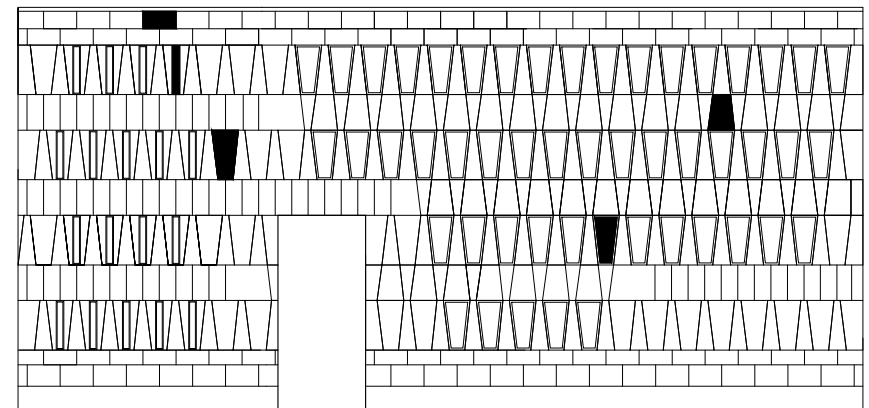
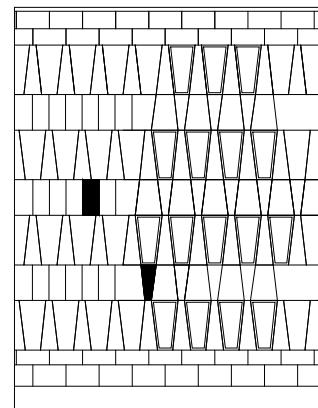
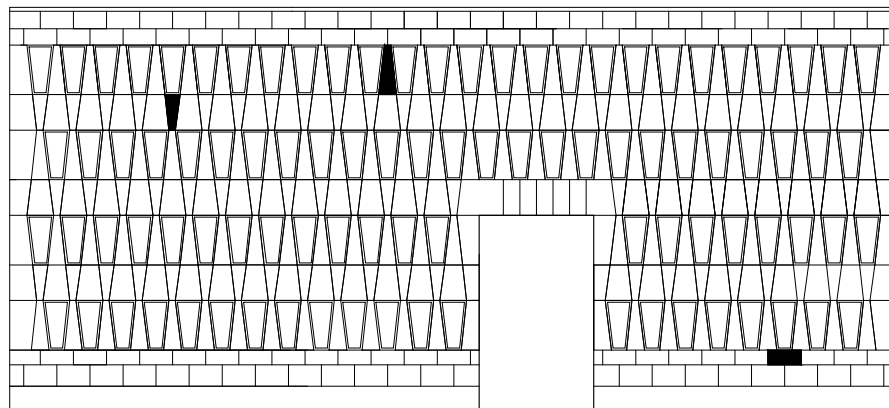

DIFFERENT SHAPES

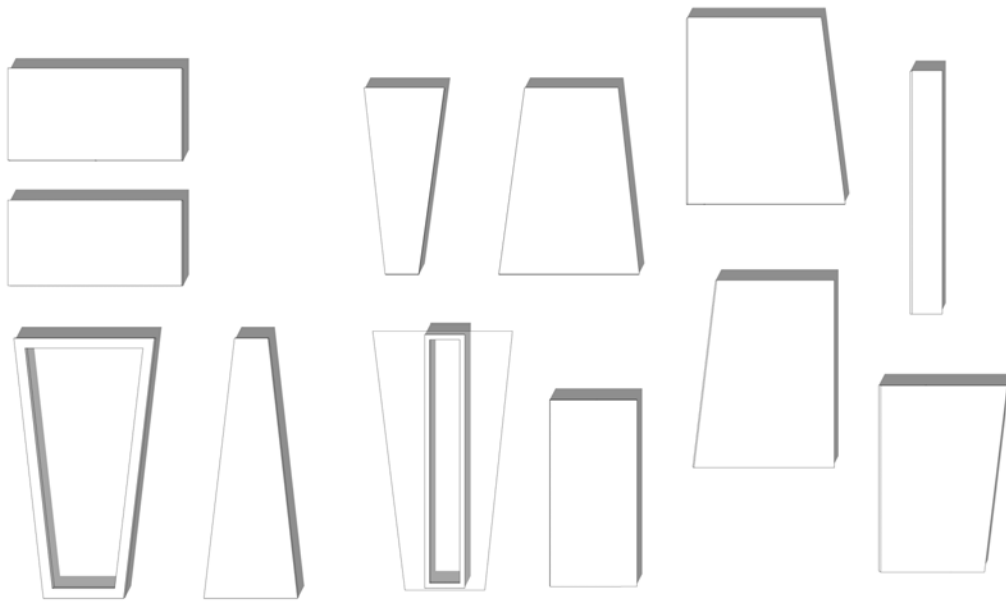

SHAPES

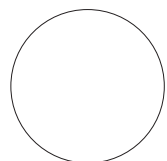

Round Lobbies

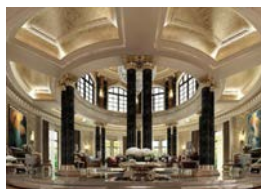

Square Lobbies



Rectangular Lobbies

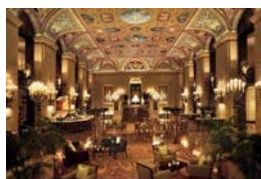

FLOORING

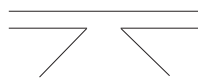

Carpeting Guidance

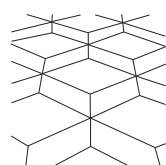

Floor Pattering

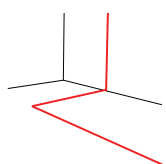

Light Guidance



columbia gaspp | 2019

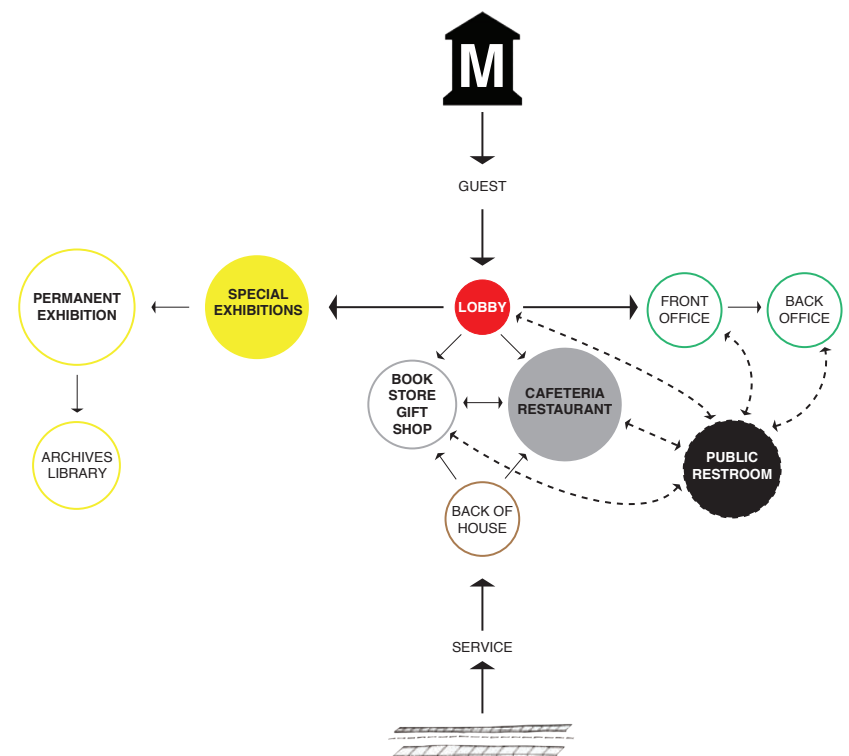
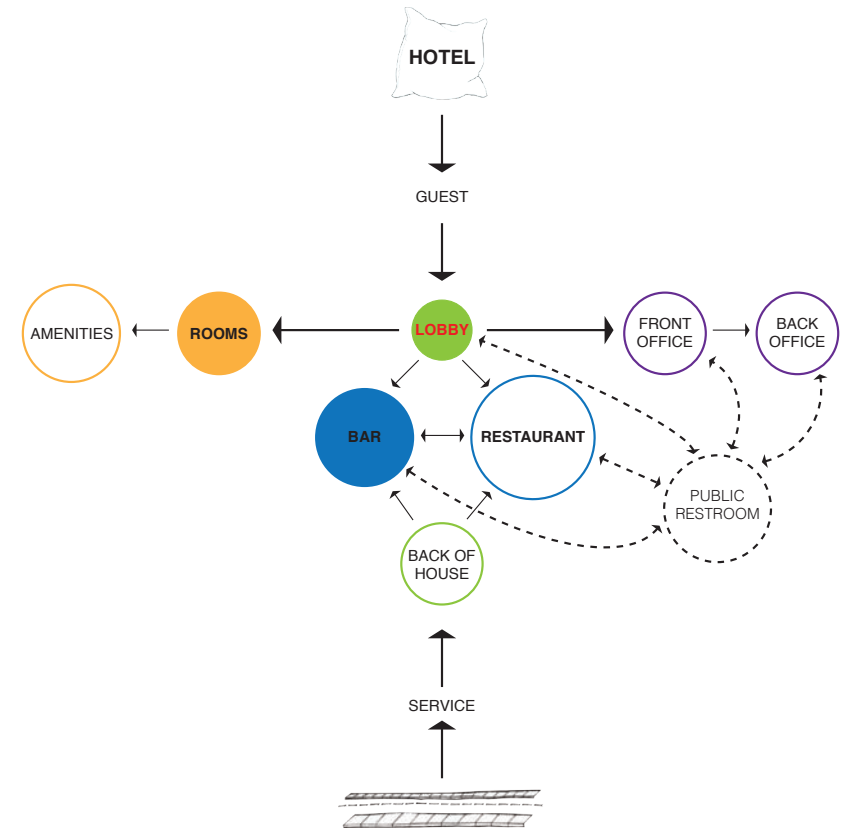

FRONT DESK

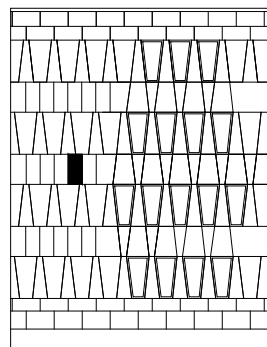
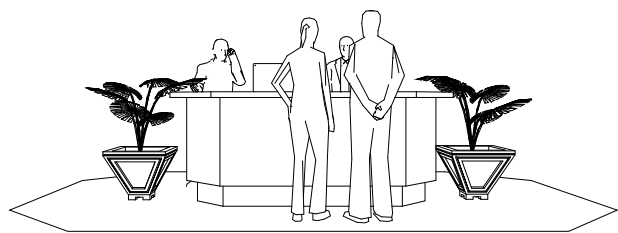

VS

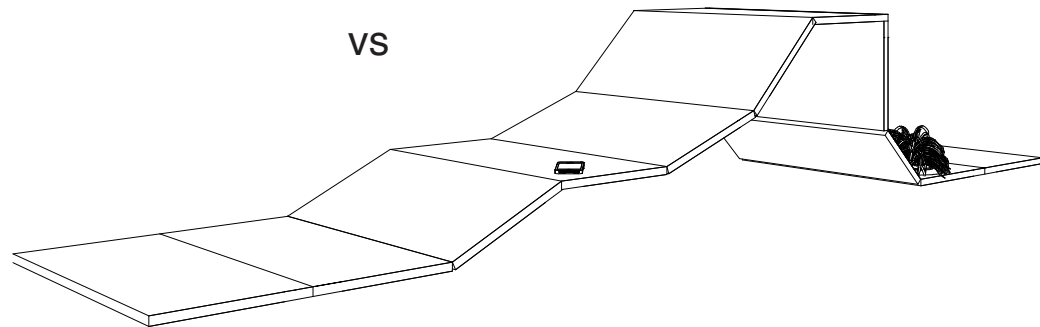

ART

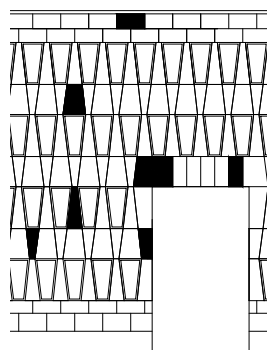
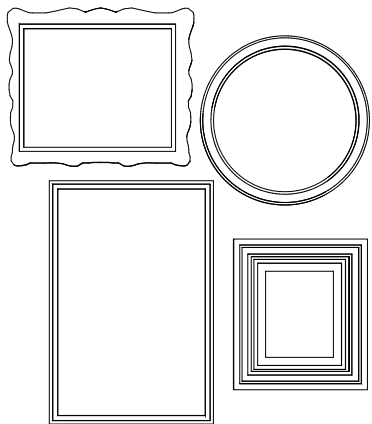

VS

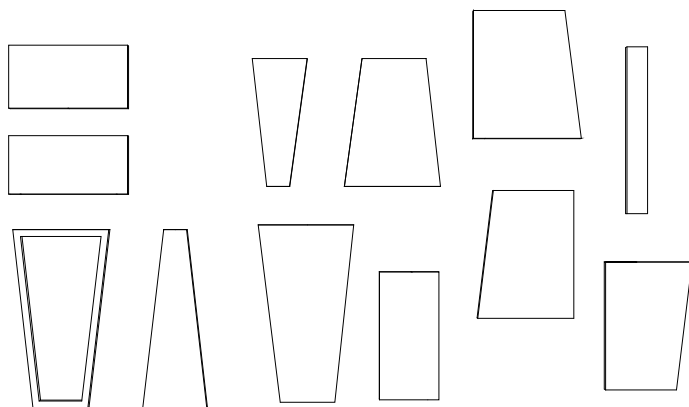

LIGHTING

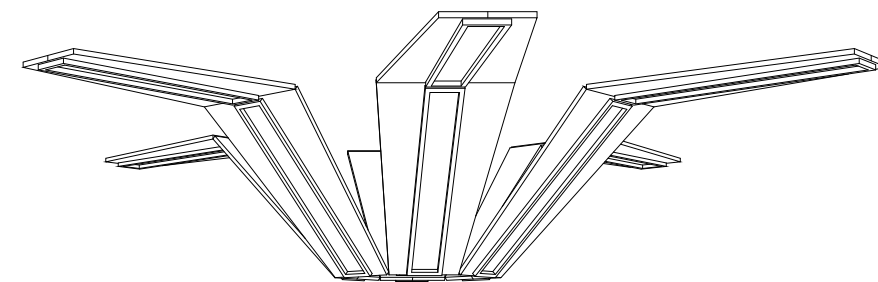
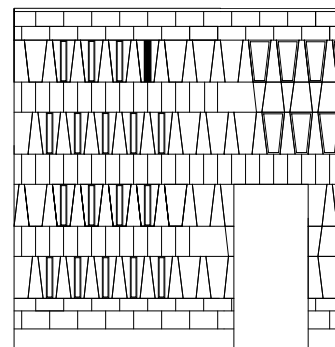

VS

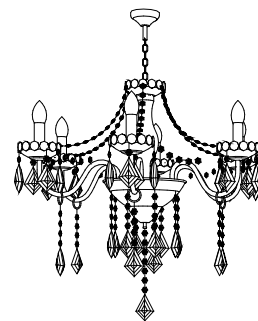

FURNITURE

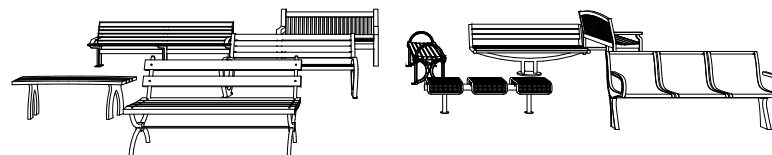
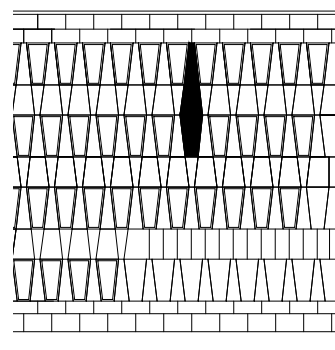

VS

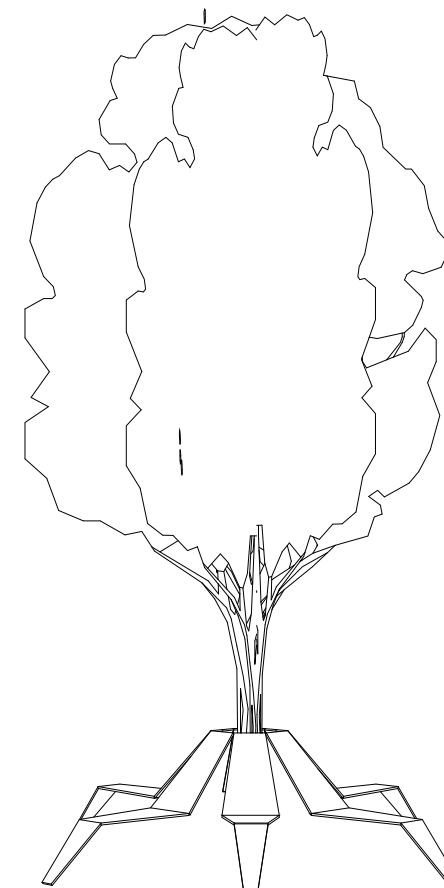
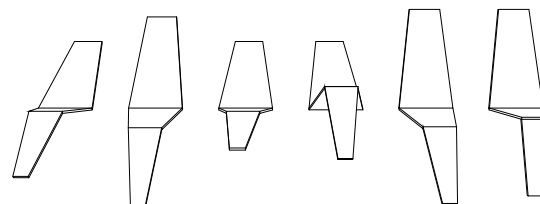

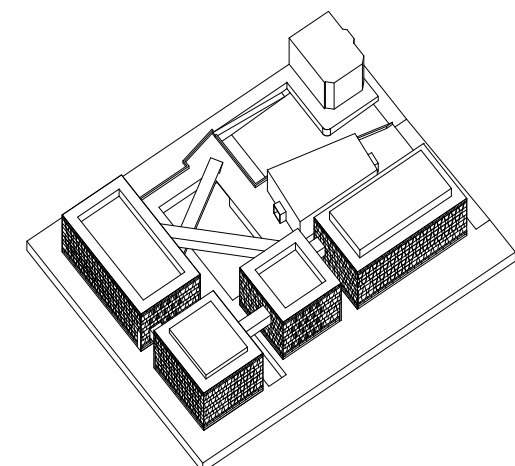
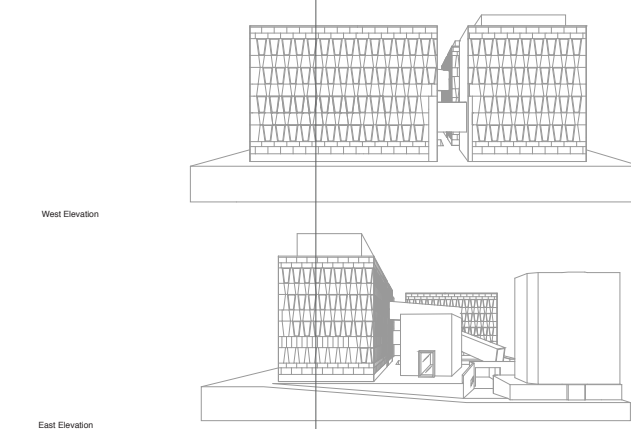
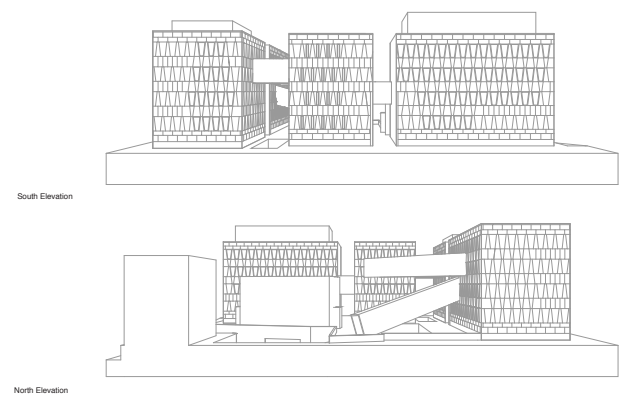
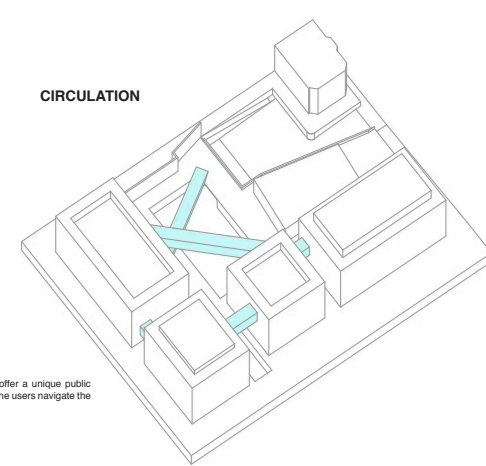
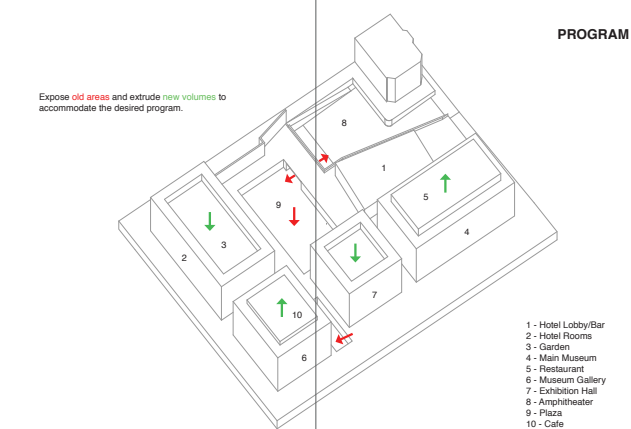
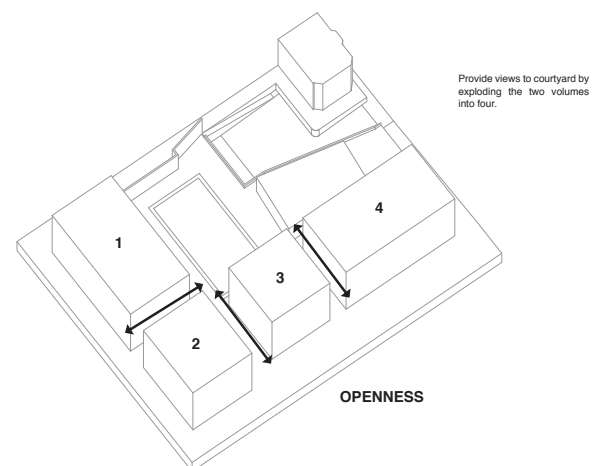
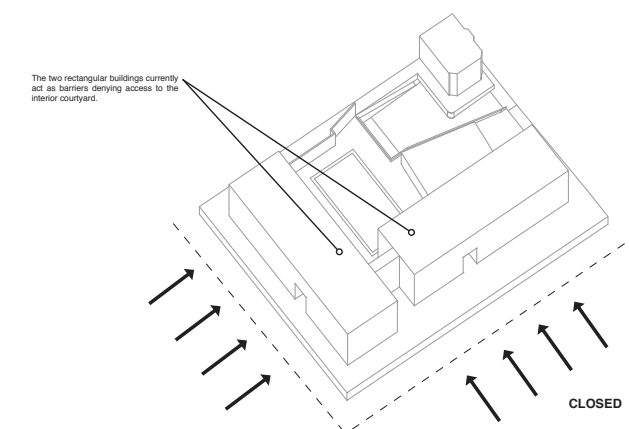
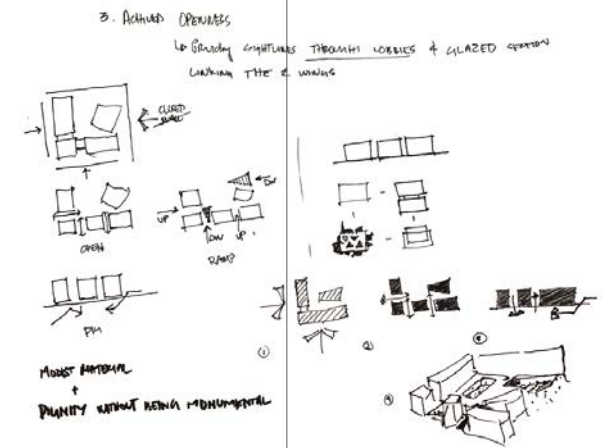

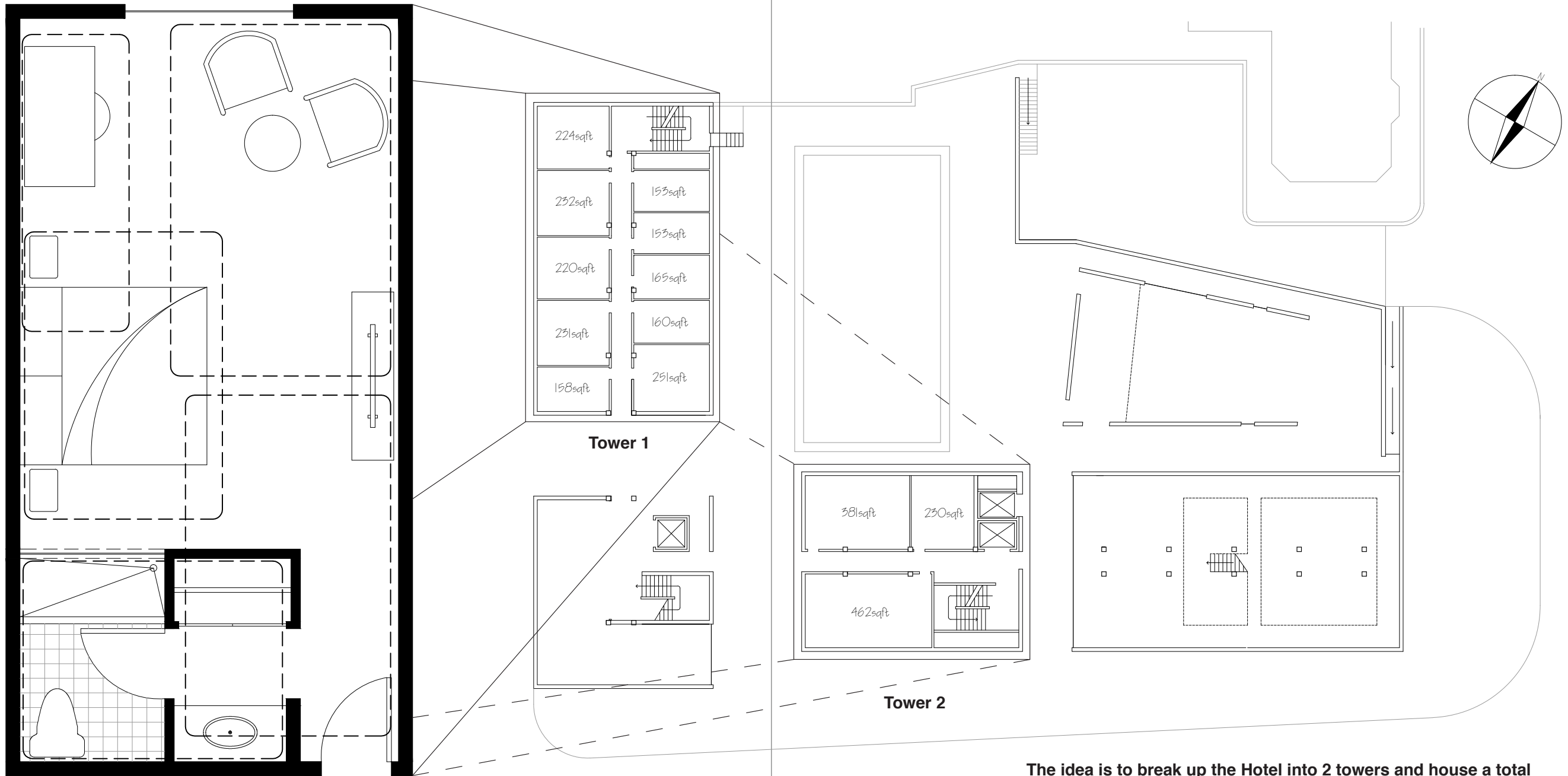

Standard Hotel Room - **357sqft**

The idea is to break up the Hotel into 2 towers and house a total of 52 rooms across all 4 floors:

(Tower 1) - 10 Rooms per Floor @ avg. of 195sqft/unit = 40 rooms

(Tower 2) - 3 Room per Floor @ avg. of 357sqft/unit = 12 rooms



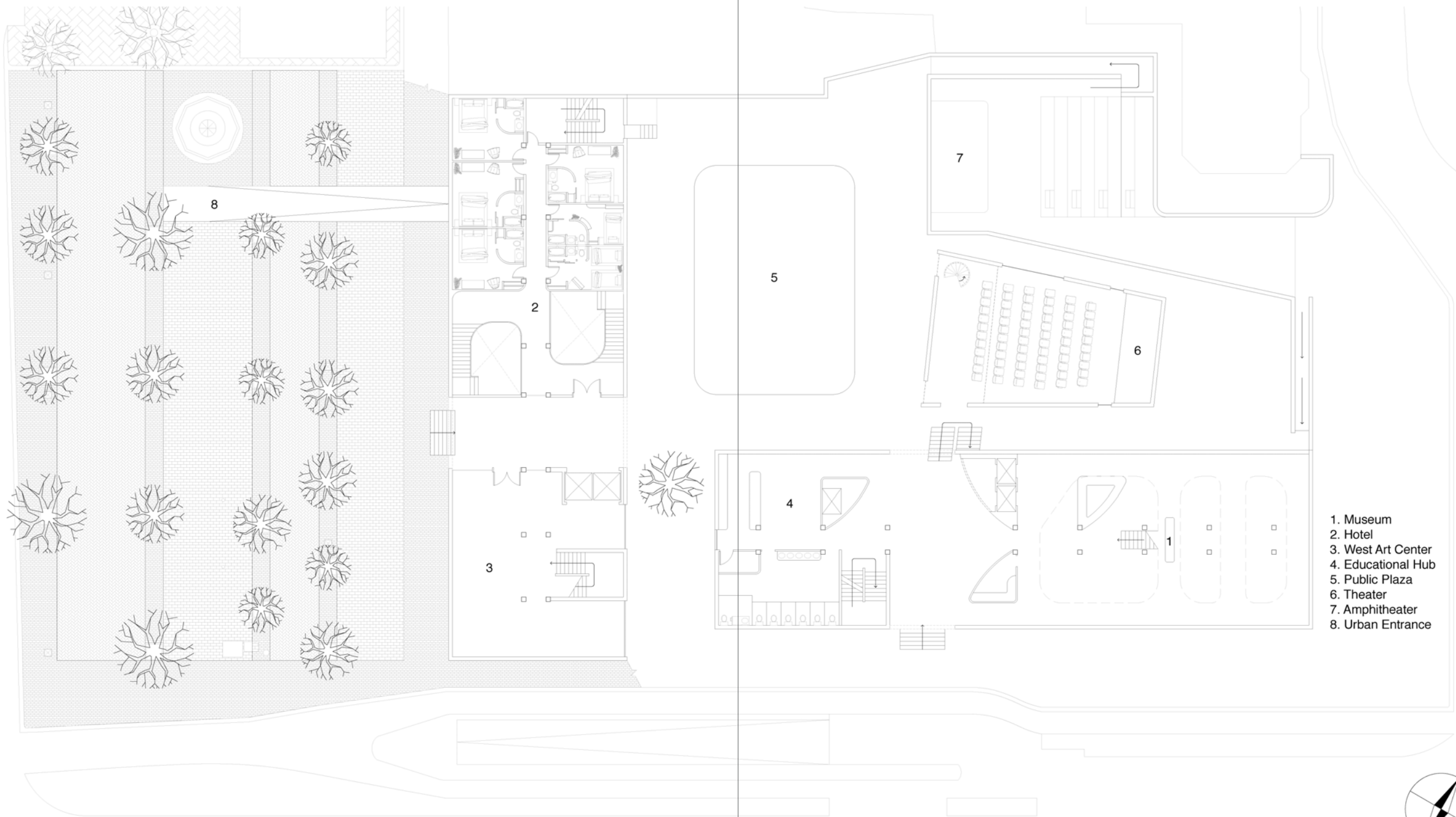

- 1. Museum
- 2. Hotel
- 3. West Art Center
- 4. Educational Hub
- 5. Public Plaza
- 6. Theater
- 7. Amphitheater
- 8. Urban Entrance

MARCEL BREUER'S US EMBASSY - GROUND FLOOR PLAN



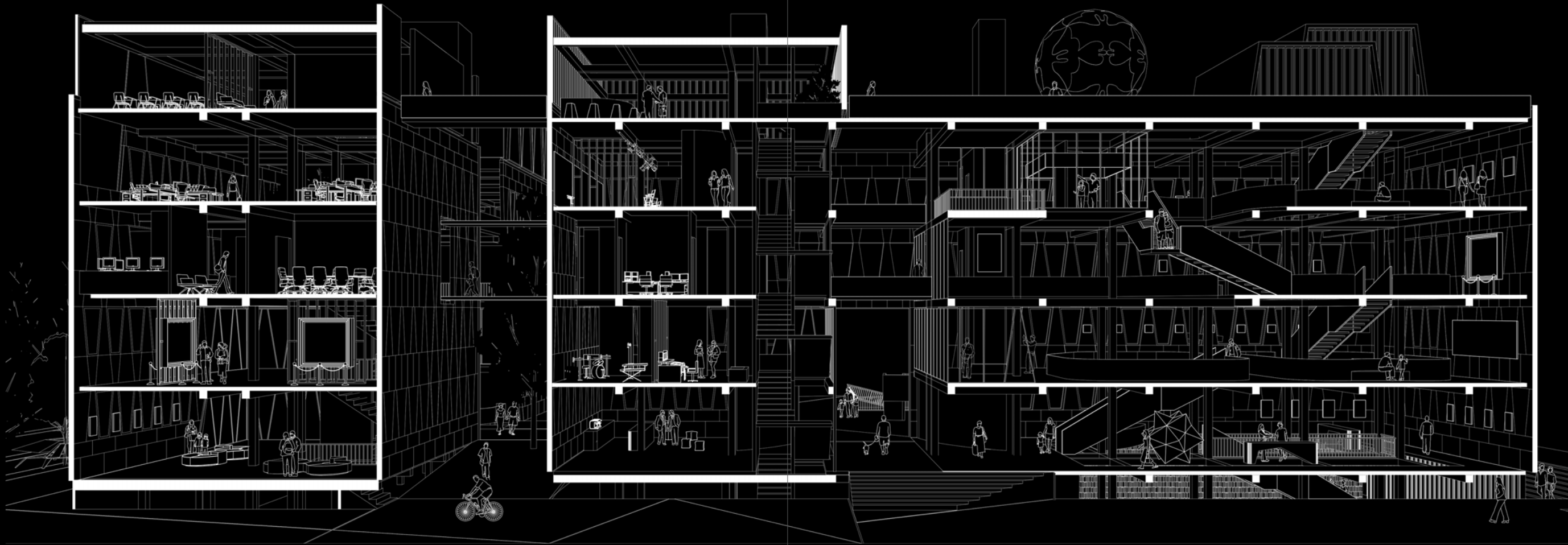









THE MAKERGRAPH STUDIO

Prof. Ada Tolla, Giuseppe Lignano, Reza Zia and Thomas Demonchaux

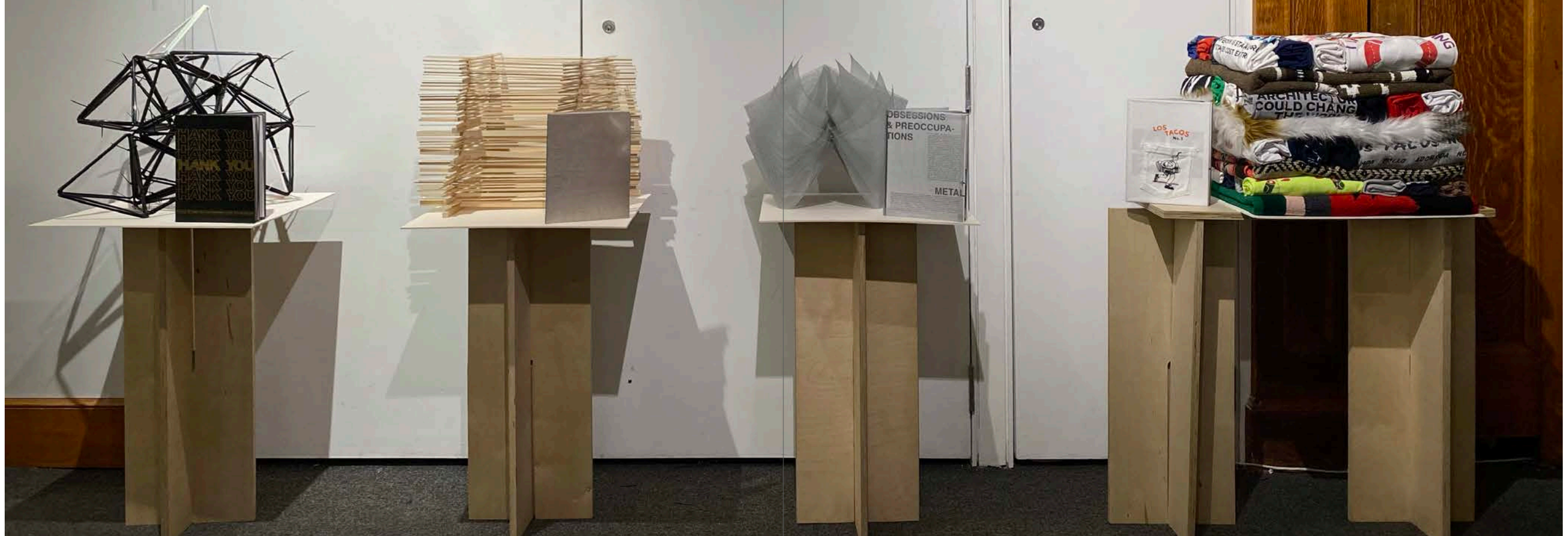

I will be sharing with you my monograph Tacos y Taco. In the first part of this book I will be addressing my ongoing preoccupations and obsessions. I will share the love I have for my 2-year-old doodle, Taco and the passion I have for eating and selling delicious tacos. I've been extremely fortunate to be part of a solution that bridges the gap of authentic street style tacos in New York City. I currently co-own and operate five Mexican Taquerias in Manhattan. Along with my weekly updates of my work, I will share the documentation and creation of four objects made from plastic, wood, metal, and fabric. At the end I will take you through my design process of designing a single-family house centered around the four objects and...the kitchen. This house is located in Manhattan's West Village and it will house a family of five, plus a doodle.



ARCHITECTURE



Architecture is my obsession. I love it so much I decided to return to school after almost 10 years of being out of the game. Through architecture I was able to pinpoint a problem and come up with a solution. I was able to capture an experience of where I'm from (Tijuana, Mexico) and bring it to a city where that experience was non existing and in high demand. I was fortunate enough to bring a little taste of Mexico to hungry New Yorkers through something small, simple, authentic, and rich of culture...tacos.

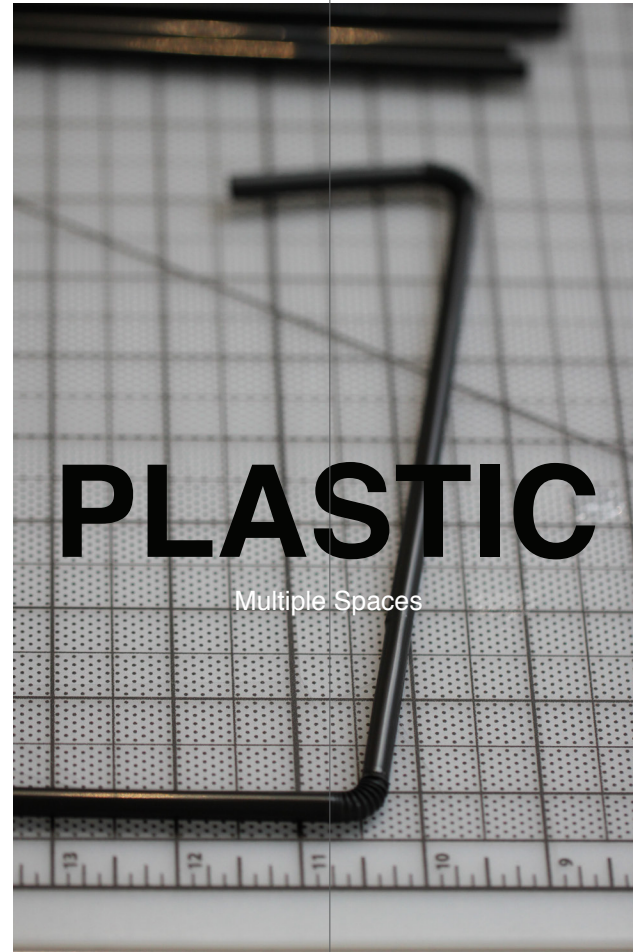
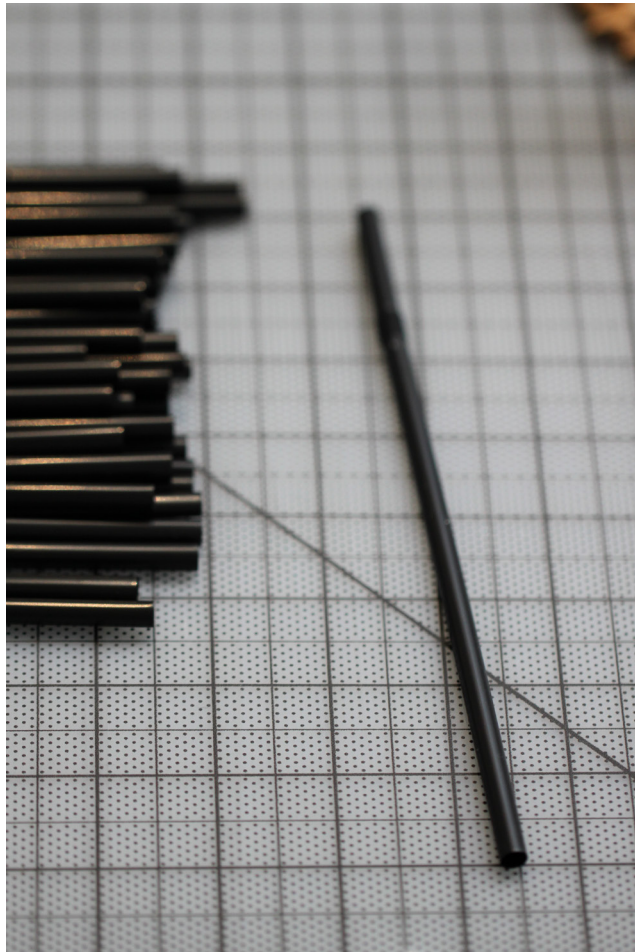

The first thing that came up in my head when I heard the word plastic was, straws. Straws are small, skinny, tall, and flexible. The challenge of building something out of straws is that a single straw by itself, is weak, therefore you need lots of straws. The second thing that came up in my head while thinking of straws was to build a Tipi out of straws. The idea is to create a network grid made out of straw modular Tipis. To keep my straw module strong, I built a pyramid composed of nine straws to fill the 18" x 18" x 18" volumetric space. Each side of the pyramid is made out of three straws. What holds the structure together is a combination of hot glue and plastic cable ties. 100% plastic.

TODAY



TODAY
GET
WASTED



Taquito, Tacoloco, Tacoberto, Taco Pineda, Taco Ramon Pineda alias el "Tacoloco", Pirulin, Pedorin or Taco is my pet dog. Taco is the first living animal that truly depends on me. If I don't feed him, Taco will die. Taco loves me and I love Taco. If I go, Taco goes. If I leave, Taco cries. I don't know how long Taco will live with me, but I know Taco will always be with me. Taco loves Tacos.



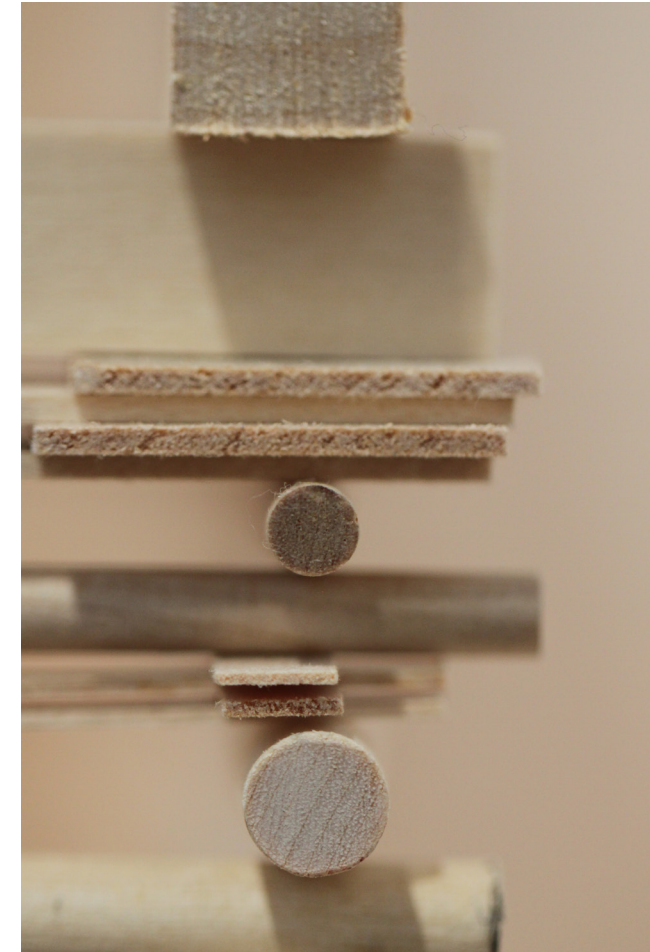
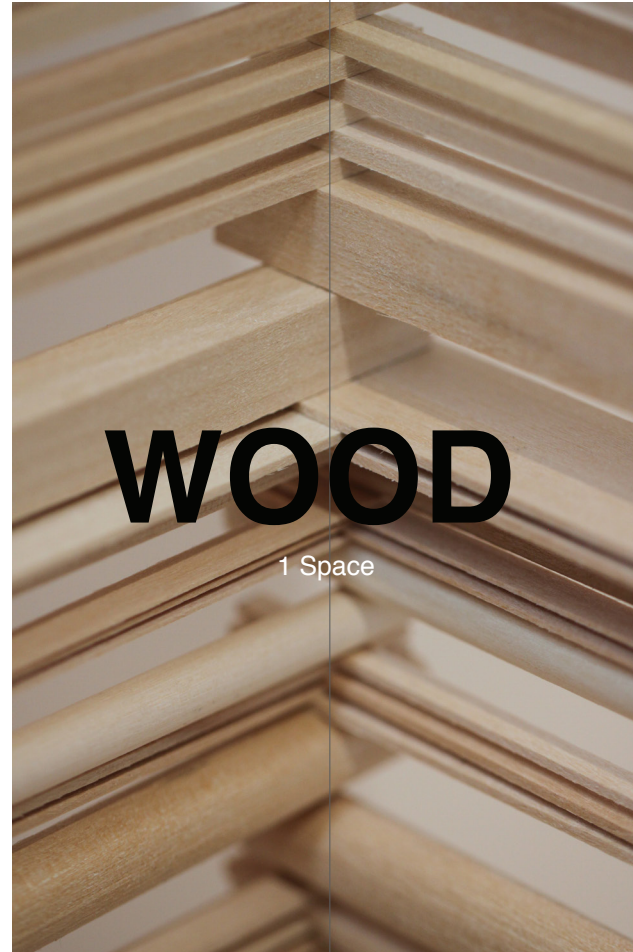

I decided to make my wood piece out of left-over basswood sticks from past models. I have so many, I can create the whole piece out of these widely spread shaped wood sticks. First, I separated each different stick by size and shape. I just started to make and build. I cut each stick to measure 18 inches and then I started stacking them one by one over each other. I made a square out of the same size wood sticks and stacked vertically to reach my desired height. The instant goal I rapidly assigned myself was to be glue-less. So, I thought to offset from each corner the placement of the cross overhang so it could provide structural strength and support at each corner. There are 18 different types of wood sticks, all the way from flat and skinny to fat and square. This wood piece consists of 190 individual wood members.



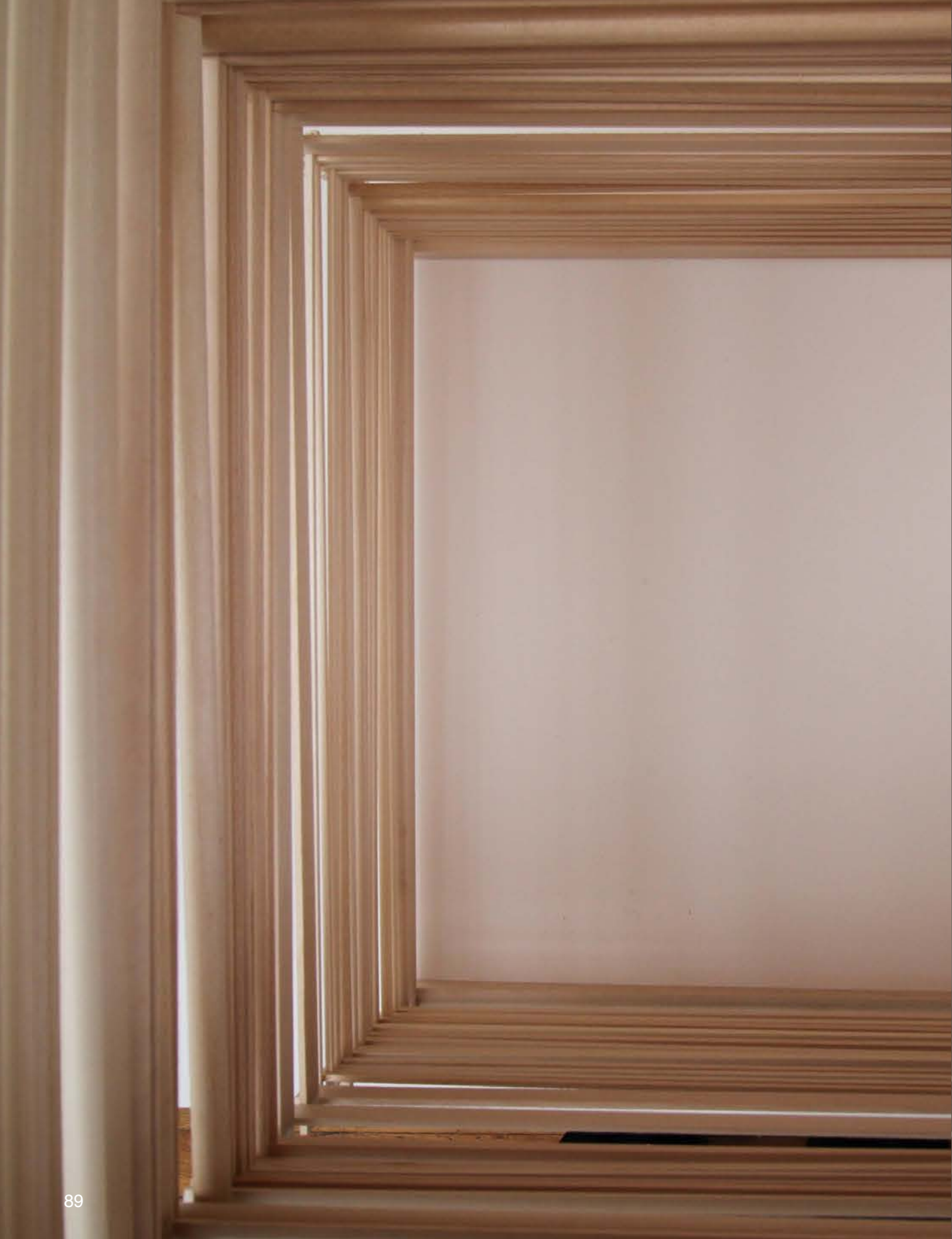

TACOS

Who doesn't like tacos? In this chapter you will see different types of tacos but mainly, my ultimate favorite: Adobada (marinated pork) tacos. Adobada or Al Pastor tacos are marinated pork tacos that meat is shaved off a vertical broiler while soaked in sizzling pineapple juice. Preparing, stacking, and serving the vertical "Trompo" is ART! Only the most skilled "Taqueros" are up for the challenge. To serve Adobada tacos the right way, you have to be incredibly fast, always have sharp knives, resist the heat, care for quality, and most important, not get clogged up. Many factors take in place when judging and grading a taco. First you look at the two most important elements in a taco: the tortilla and the salsa. Only after you taste and judge those two taco elements, you can move on to the flavor of the meat. If the tortilla and salsa are good, then the meat does not matter as much. If I could anything for the rest of my life, it would probably be tacos.



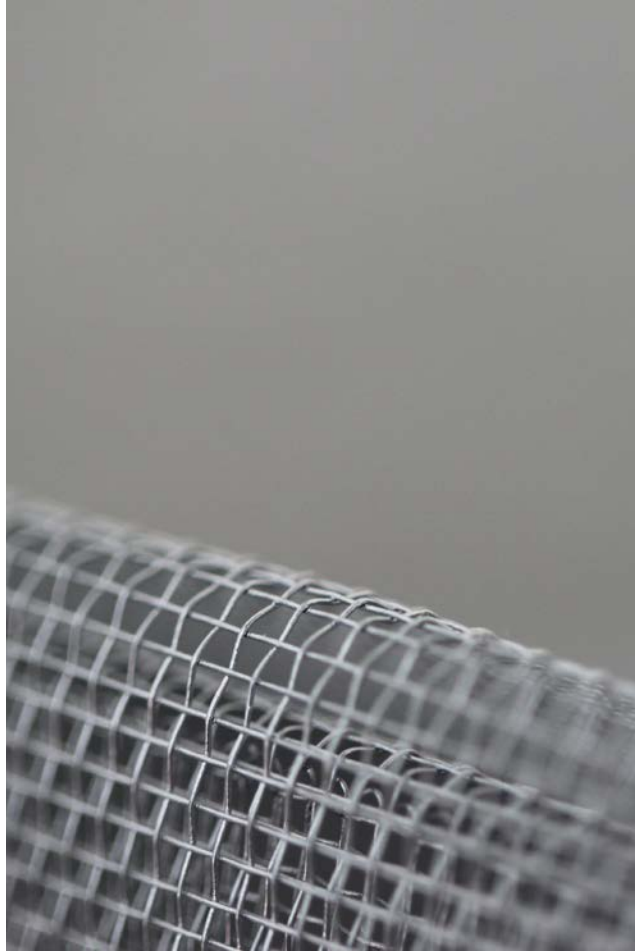

When I think of metal I think: heavy, shiny and hard. Instantly, my approach to create two metal volumes (Top and Bottom) is to show the opposite through its construction. I want to build something light and flexible. My first idea is to use old dry-cleaning hangers to build the object. I tried it, but I was very unsatisfied with the hanger's rigidity and appearance. The end result seemed unfinished and out of place. Next idea, Origami! First, I played around with a piece of paper to test the form. Then, moving forward to a thin metal mesh screen seemed adequate. The idea is to fold the thin mesh sheet into an inspired origami shape that meets clearance requirement. I first cut the sheet into a 3ft x 3ft square, then I fold each corner into the center forming a 26in x 26in square. After that, I flip the folded square and fold all four folded corners into the center again, forming a 18in x 18in square. Finally, I just start flipping, folding, tugging and pulling until I arrive to my desired and compliant form.

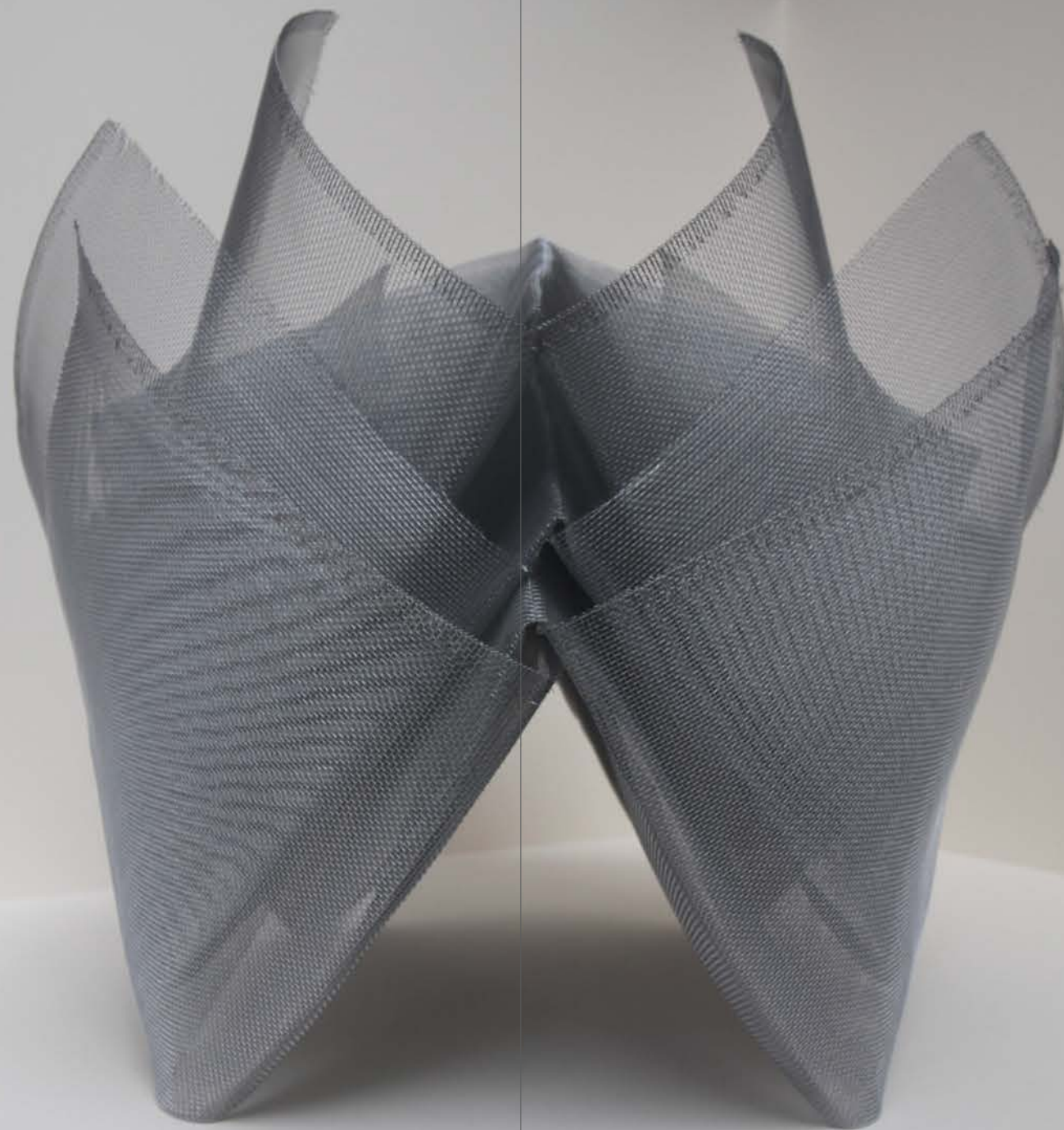



THE HUSTLE

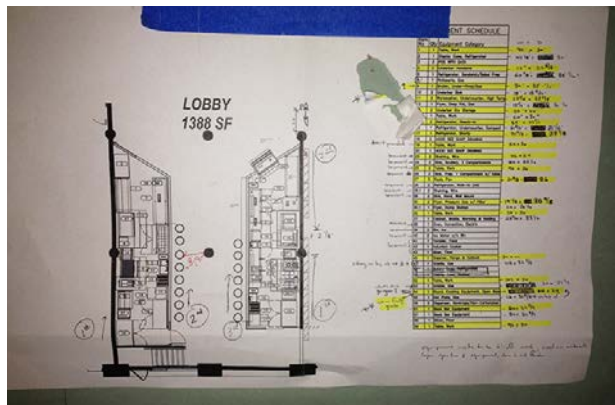

In this chapter, I will share with you my main pre-occupation. A pre-occupation that unconsciously started ever since I can remember and has never left me...hustling. I know, how uninteresting and blah! The truth is, I've been selling anything I can put my hands on; all the way from Mexican candy when I was in third grade to homemade sandwiches in high school. If there's one thing I'm sure about myself (or that I like to think of myself as) is that I'm an architect at heart while an entrepreneur in spirit. I've been grateful enough to be part of various experiences that have pushed me to become what I am now, a restaurateur. I own and operate five restaurants in New York City. Here I don't just sell food; I sell an experience. Fortunate enough, it's an experience that formed me back home, Tijuana, Mexico. To me, architecture is about problem solving. I used the problem-solving skills I learned in architecture school to help me build a solution to a problem I faced while living in New York –no authentic Mexican street tacos. And that's how the whole idea started. I will share my graphic story of this ongoing journey by first showing you the one thing you always need to start anything in life: the idea, the concept.





I will be making this fabric piece out of my old t-shirts that rarely get worn but are hard to throw away. I first think to create a t-brick with the correct dimension to completely fill the 18"x18" plane. The dimensions of the t-brick are: 9"x4 1/2"x ?" It takes 12 t-bricks to fill the plane. I fasten the t-brick with 2 cloth rope strings to secure its structure, then I start staking in hope to reach my desired 18" height. Because of the compressed height of the t-bricks and running out of t-shirts I was only able to fill 4 layers of t-bricks (48pcs). It seemed I needed 36 more t-shirts. To help with the height, I inserted cloth layers: 1 old blanket, 1 poncho and 1 sarape. In my opinion, the basic idea of jam packing the 18"x18"x18" space with fabric material lead to a rich outcome, a big brick composed of my memories.

TODAY





I ask myself, what makes a house a home? According to Google: "A home is a place of love and warmth. In a home you have things around you that are special and have meaning, but most of all you are surrounded by people you love and who love you. A family makes a house a home by living in it and making it unique and special." I interpreted this as Family is home. The home I will be designing is for a family of six. Two parents (both 55 years of age), a 20-year boy, an 18-year girl, a 12-year boy, and a 14-year-old doodle. The site is located in New York City's West Village. The size of the lot is close to 5,000 sqft. Yes, another four-story mega-mansion in the Village, however this one is unique as it will never exist. This is the concept of a house as a home. What brings the family together once inside a home? The kitchen. The kitchen is the soul of the house. Everything and everyone revolve around the kitchen. This is the place where laughters are shared, where guests are fed and entertained, where family meets, where goodbyes occur, and where stories begin. The idea behind designing this house is to first start from the inside, the core, the nucleus, the kitchen. I will start designing from within in and gradually explore the connections through different experiences that slowly steer the user to the exterior world. Through these experiences the family will manifest their own individuality and share it with you. The home's authenticity will be painted throughout the house and will be composed of my four objects built in previous chapters. The modularity of plastic straws, the transparency of wood sticks, the flexibility of metal mesh, and the personality of my fabric t-shirts. Observing the behavior of my four objects, drives the decision behind utilizing all of the objects to achieve a denser outcome. This house is also about density, there's density in the programmatic layering, density in the location, and density in the family. Houses are living mechanisms that provide essential services to our lives. I want to uncover the engine of this house to reveal the home's soul. At the same time, I would like this home to be flexible and sustain a change of ownership, of family, of love, and quickly adapt.



HOUSE AS HOME

The Idea

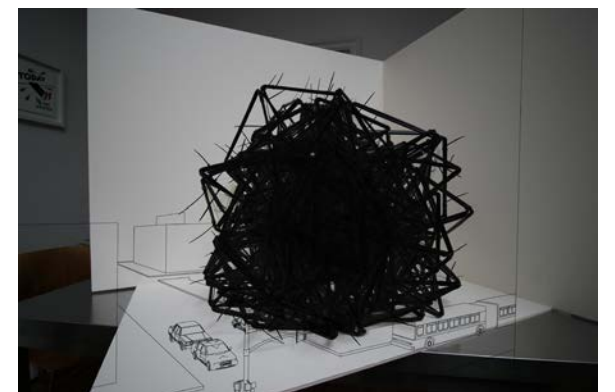
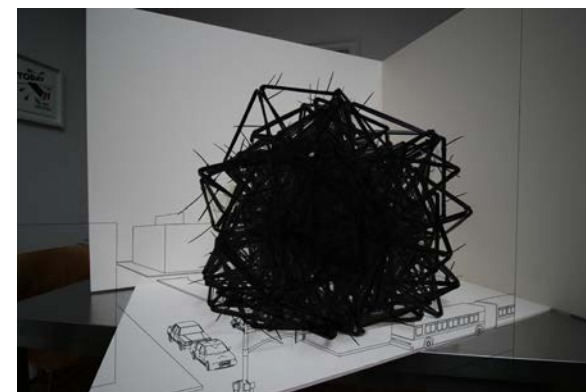
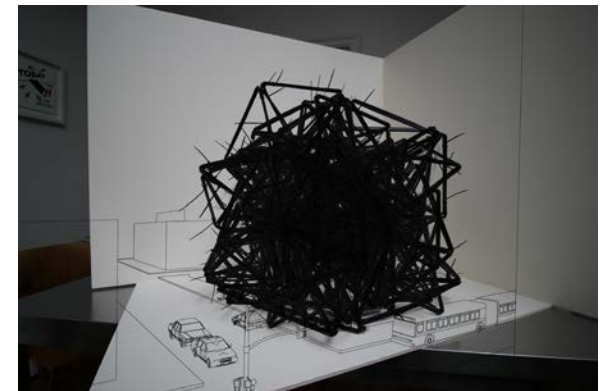
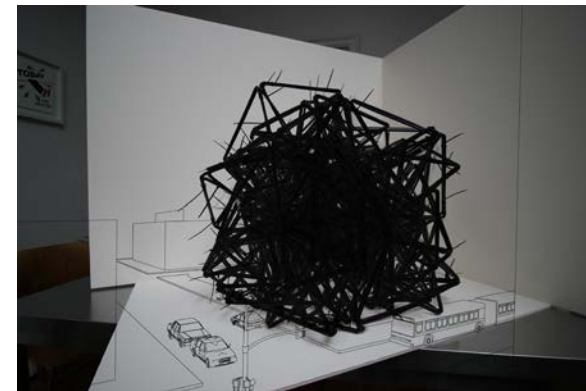
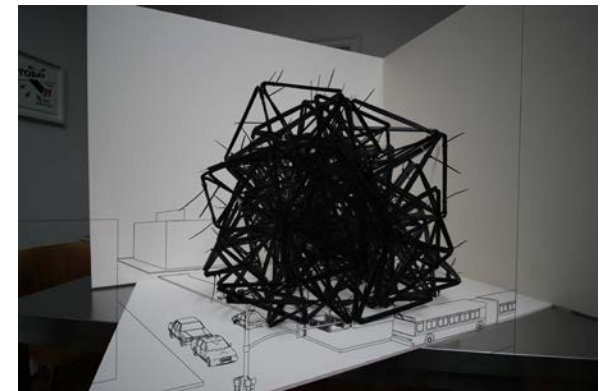
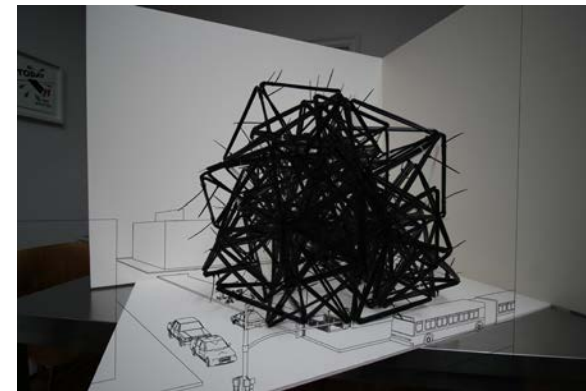
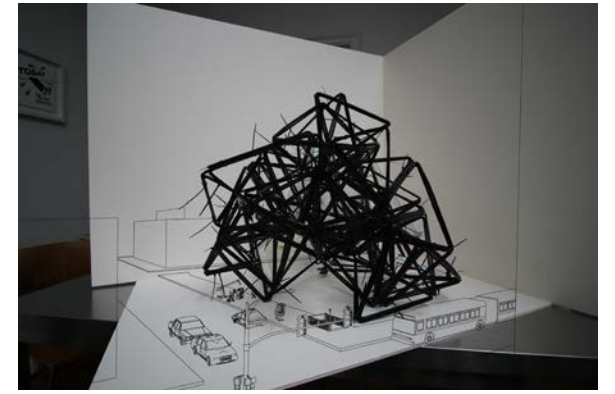
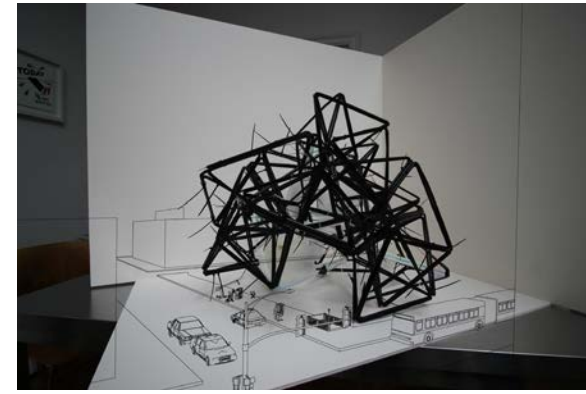
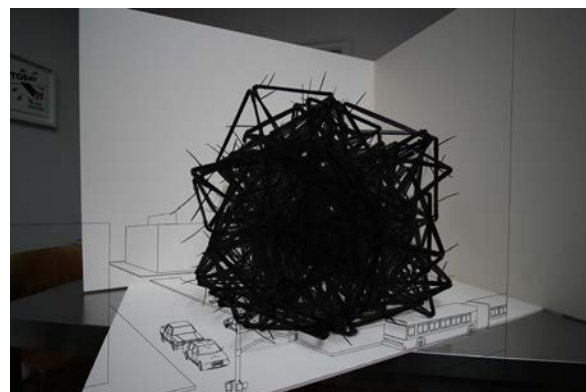
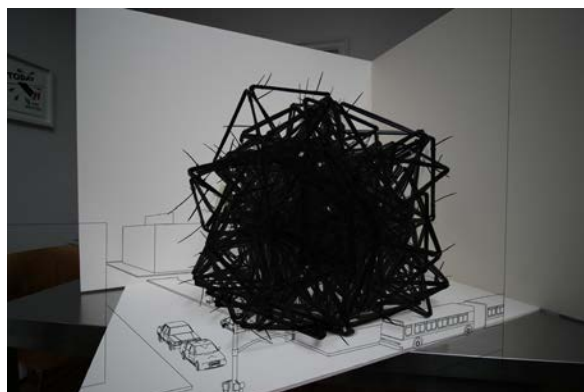
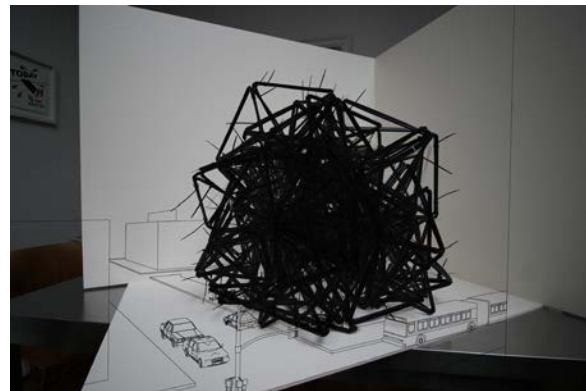
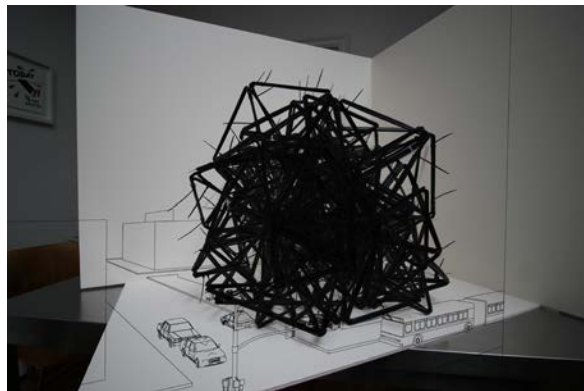
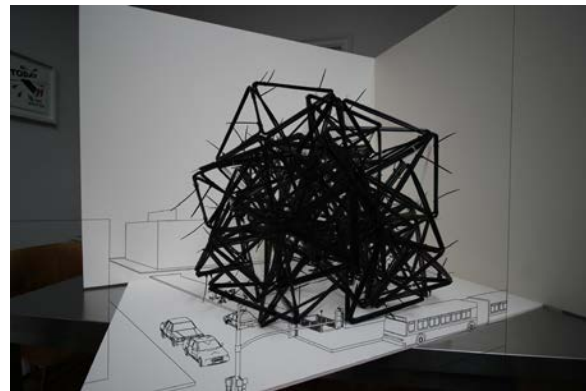
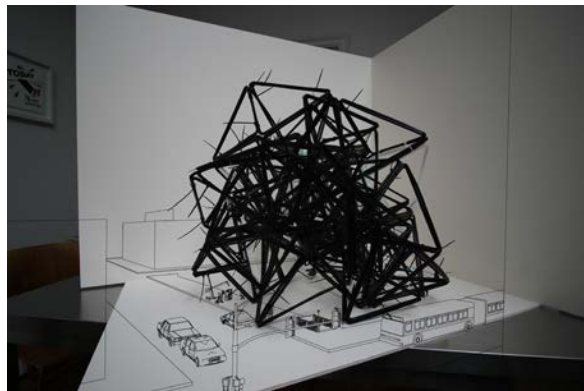
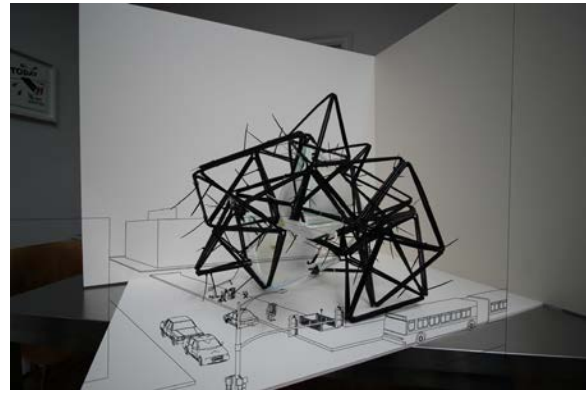
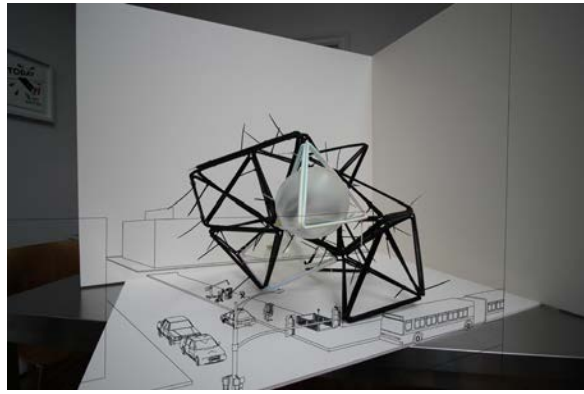

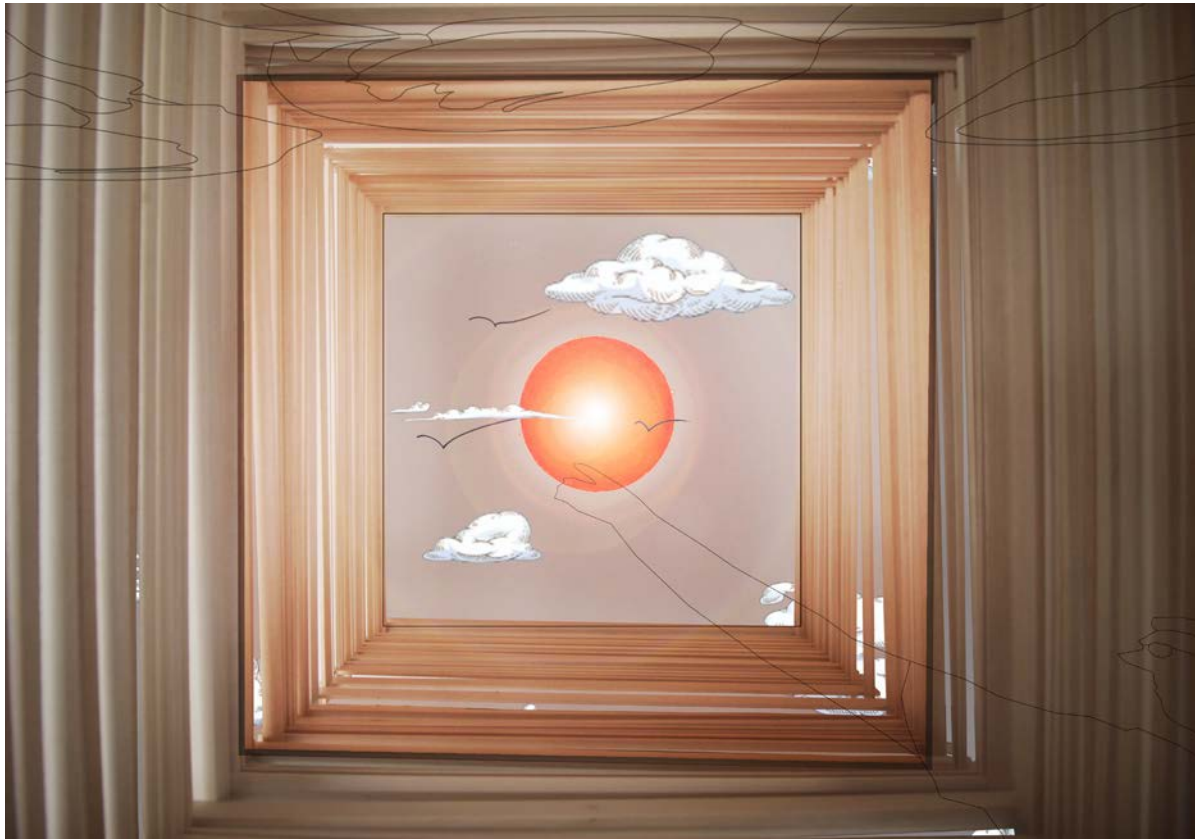

WOOD TRANSPARENCY = SHELL = FENCE



FABRIC = PERSONALITY = COMFORT = INSULATION



METAL = FLEXIBILITY = PARTITIONS = KITCHEN



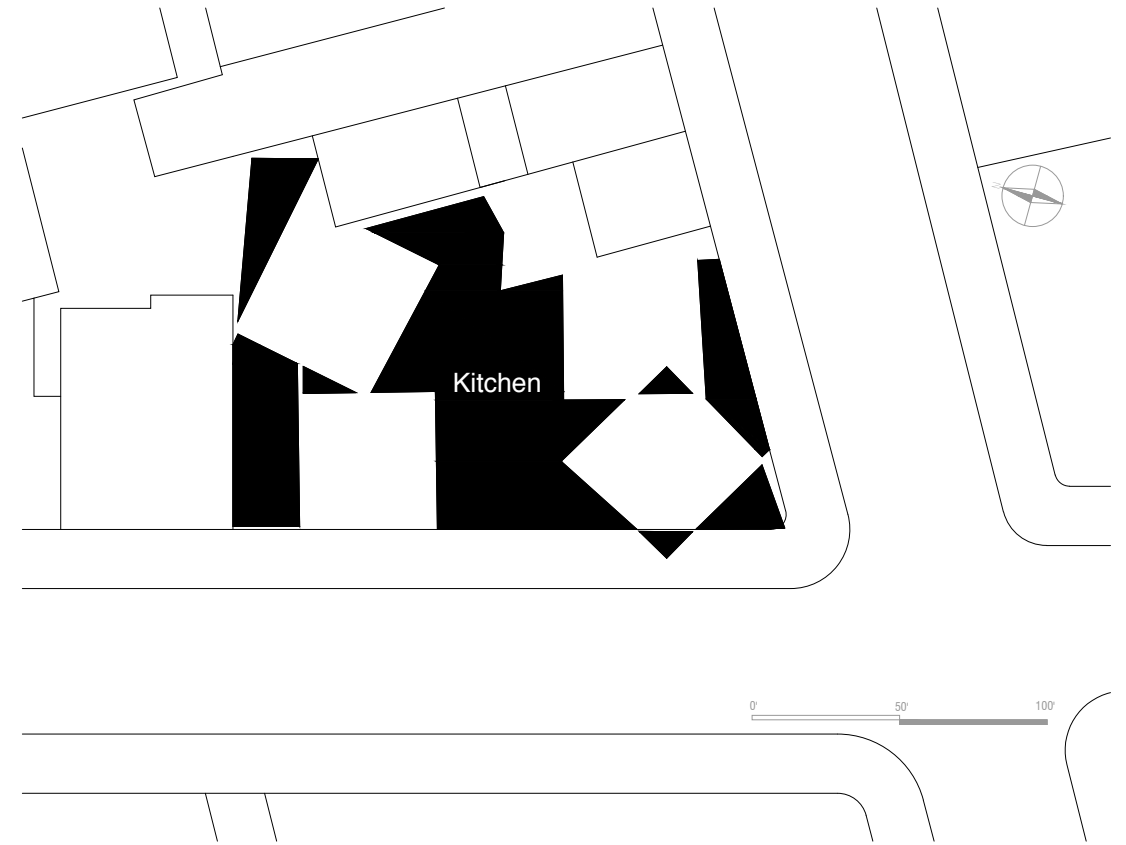
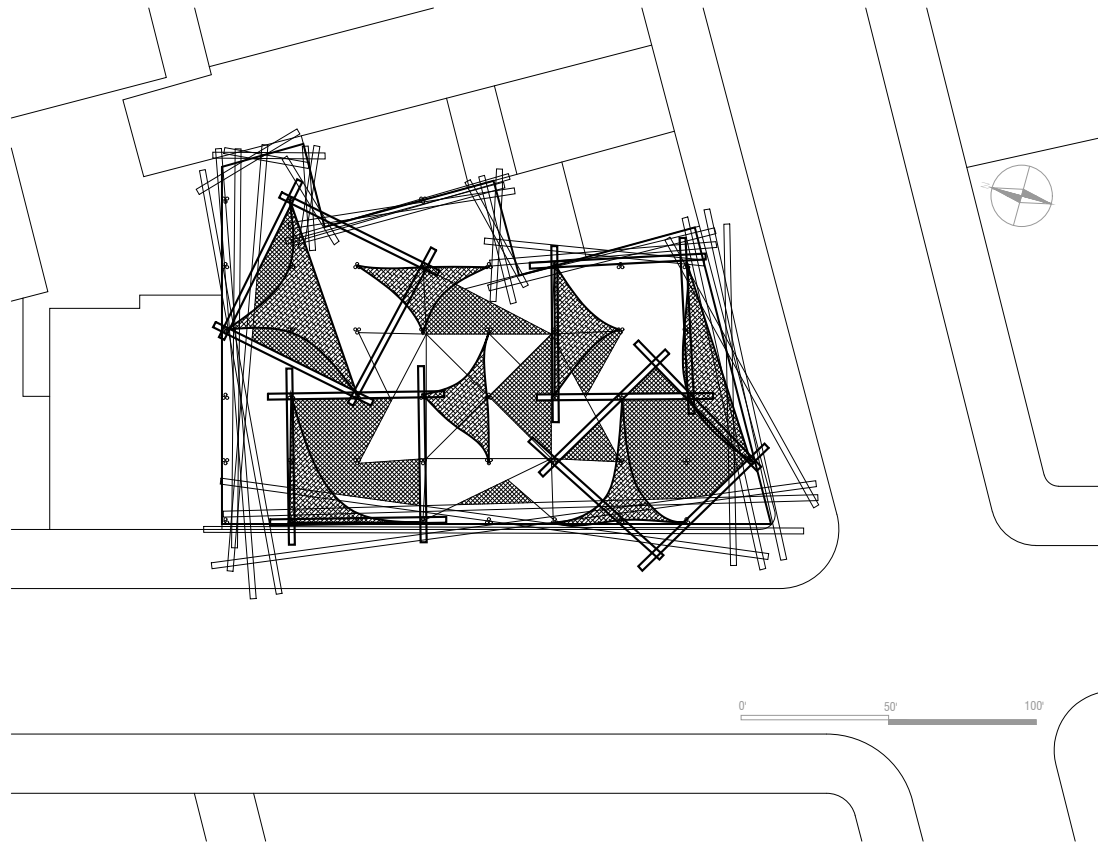

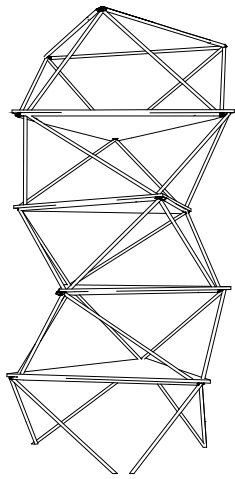

Plastic as Structure

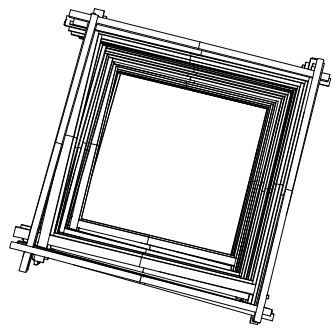

Wood as Fence

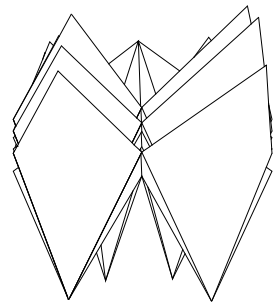

Metal as Walls

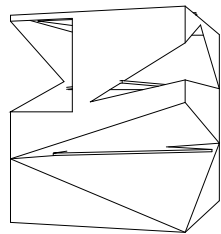

Fabric as Insulation

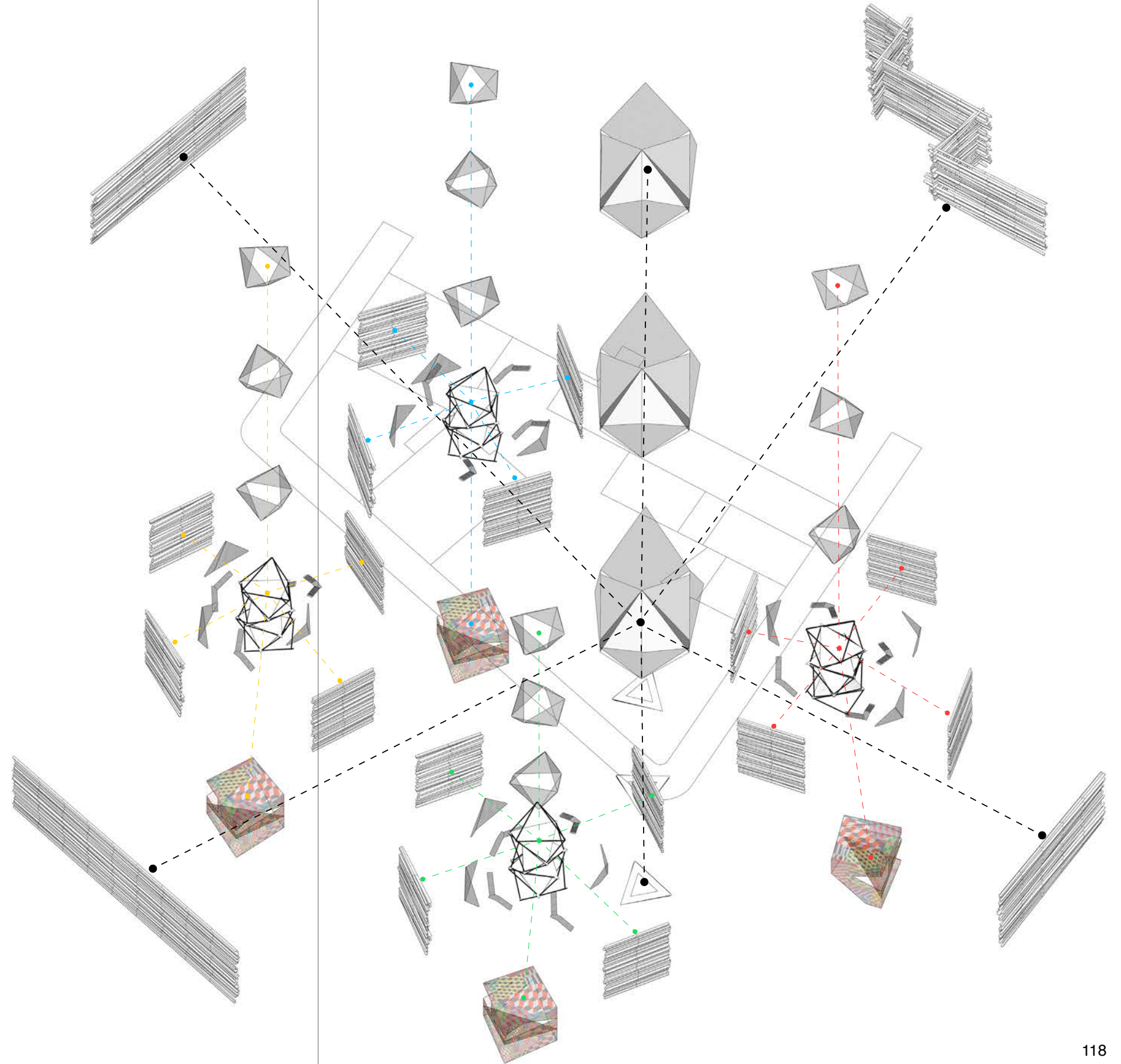

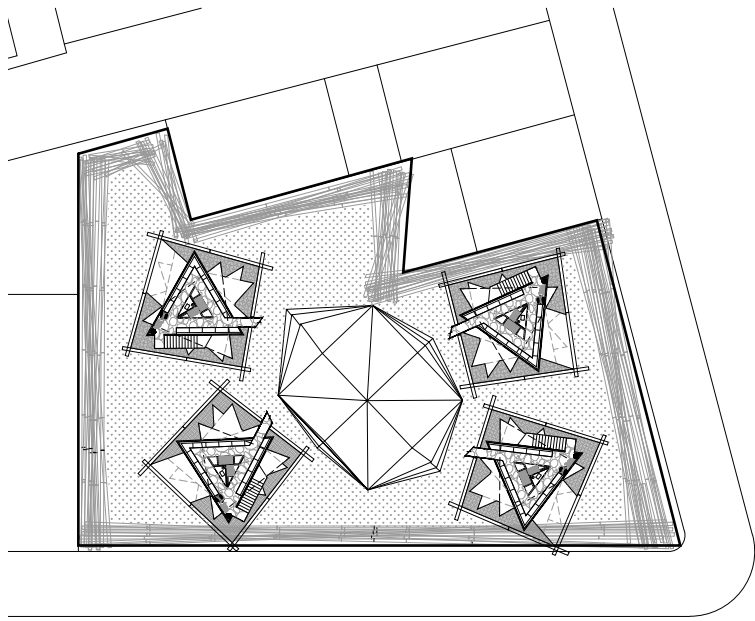

Site Plan

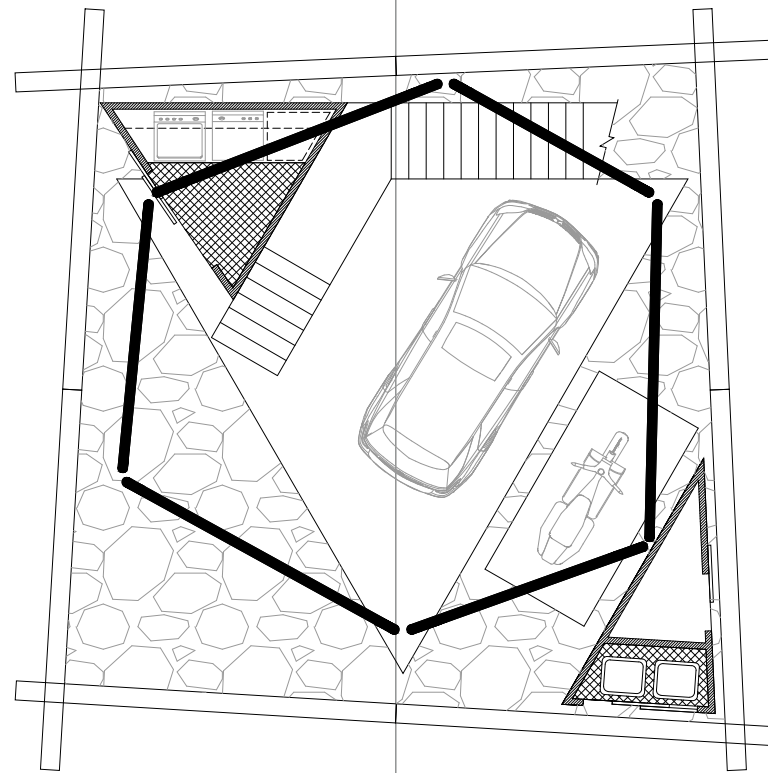

Ground Floor Plan

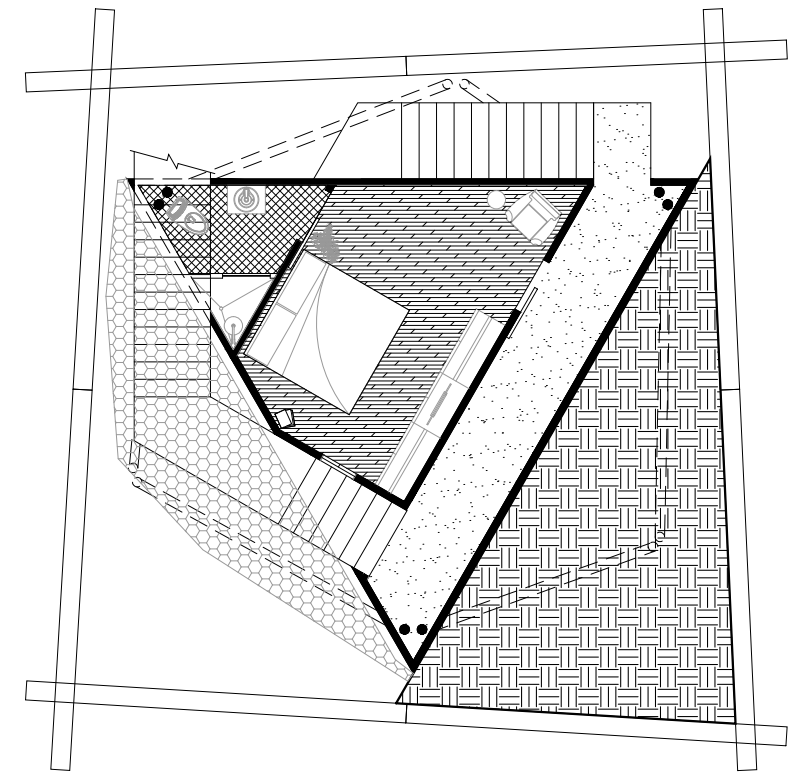

First Floor Plan

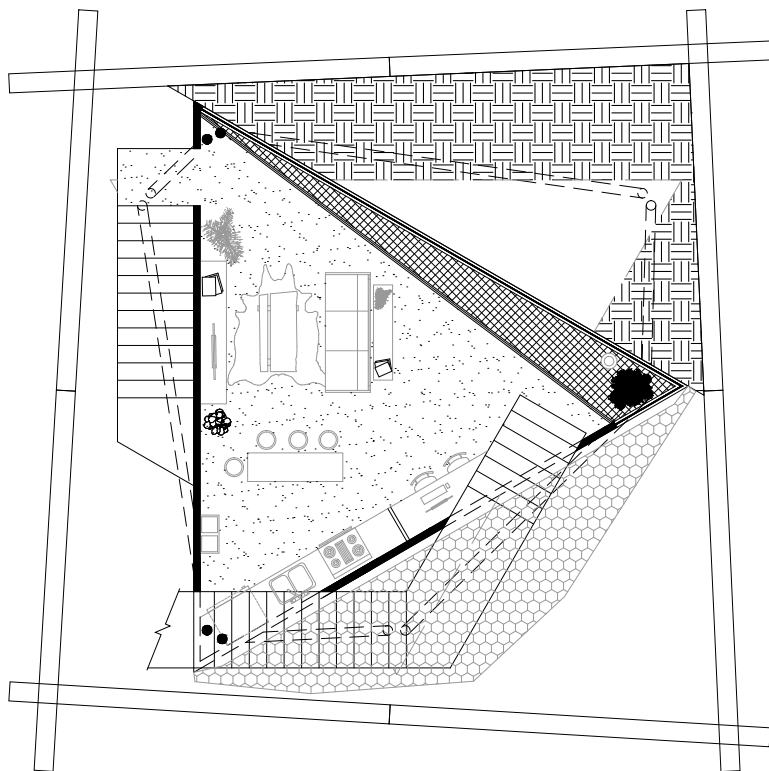

Second Floor Plan

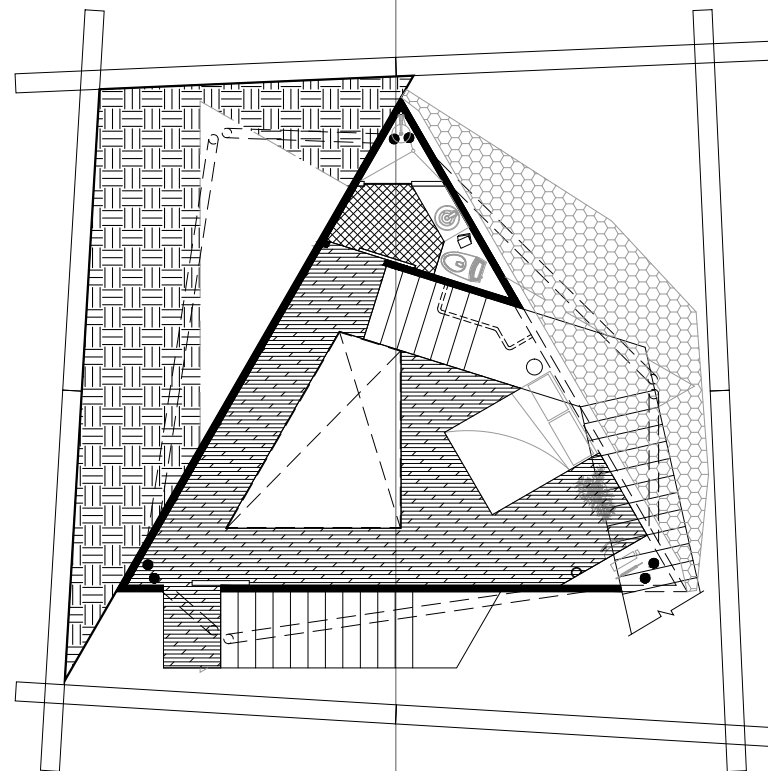

Third Floor Plan

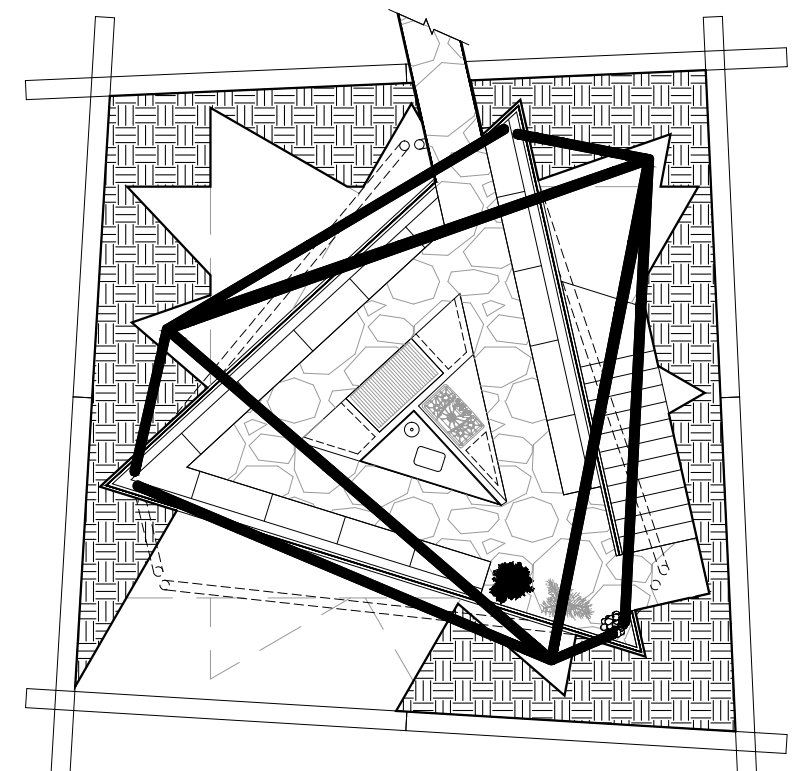

Roof Plan

Fabric

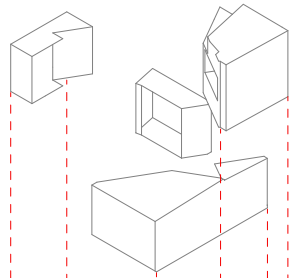

Insulation & Closets

Metal

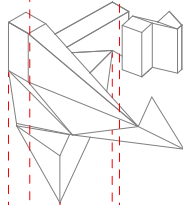

Partitions & Circulation

Concrete

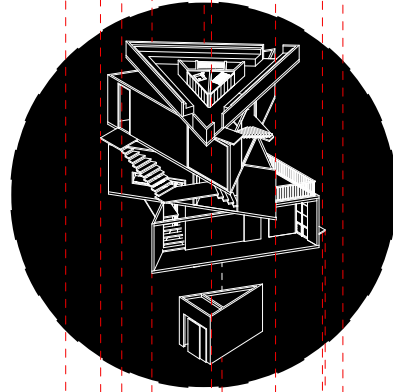

Walls and Slabs

Plastic

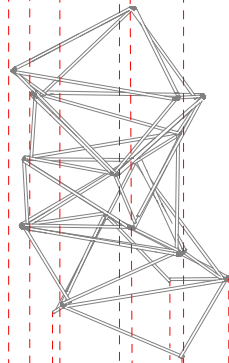

Structural Grid

Wood

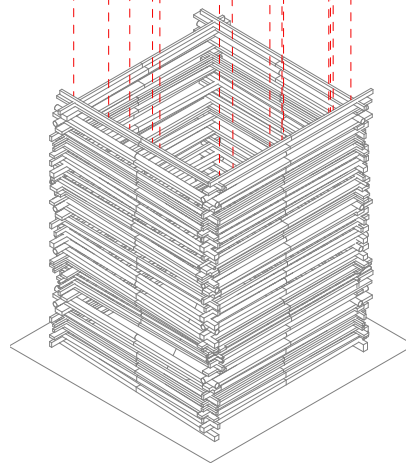

Fence

Roof Deck

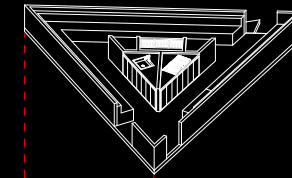

Exterior Kitchen

Third Floor

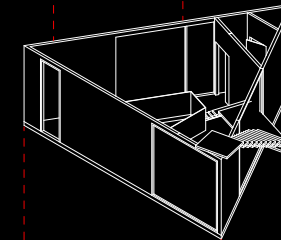

Loft & Bathroom

Second Floor

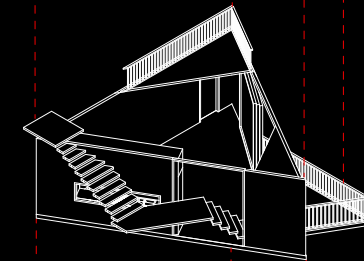

Kitchen & Living

First Floor

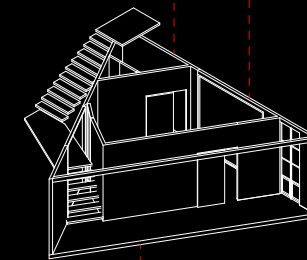

Master Bedroom & Bathroom

Ground Floor

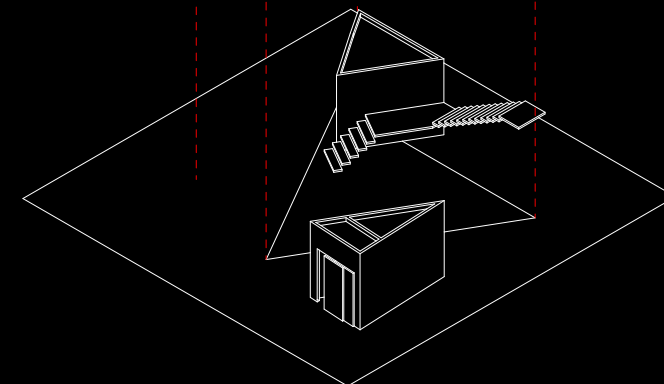

Utilities & Services

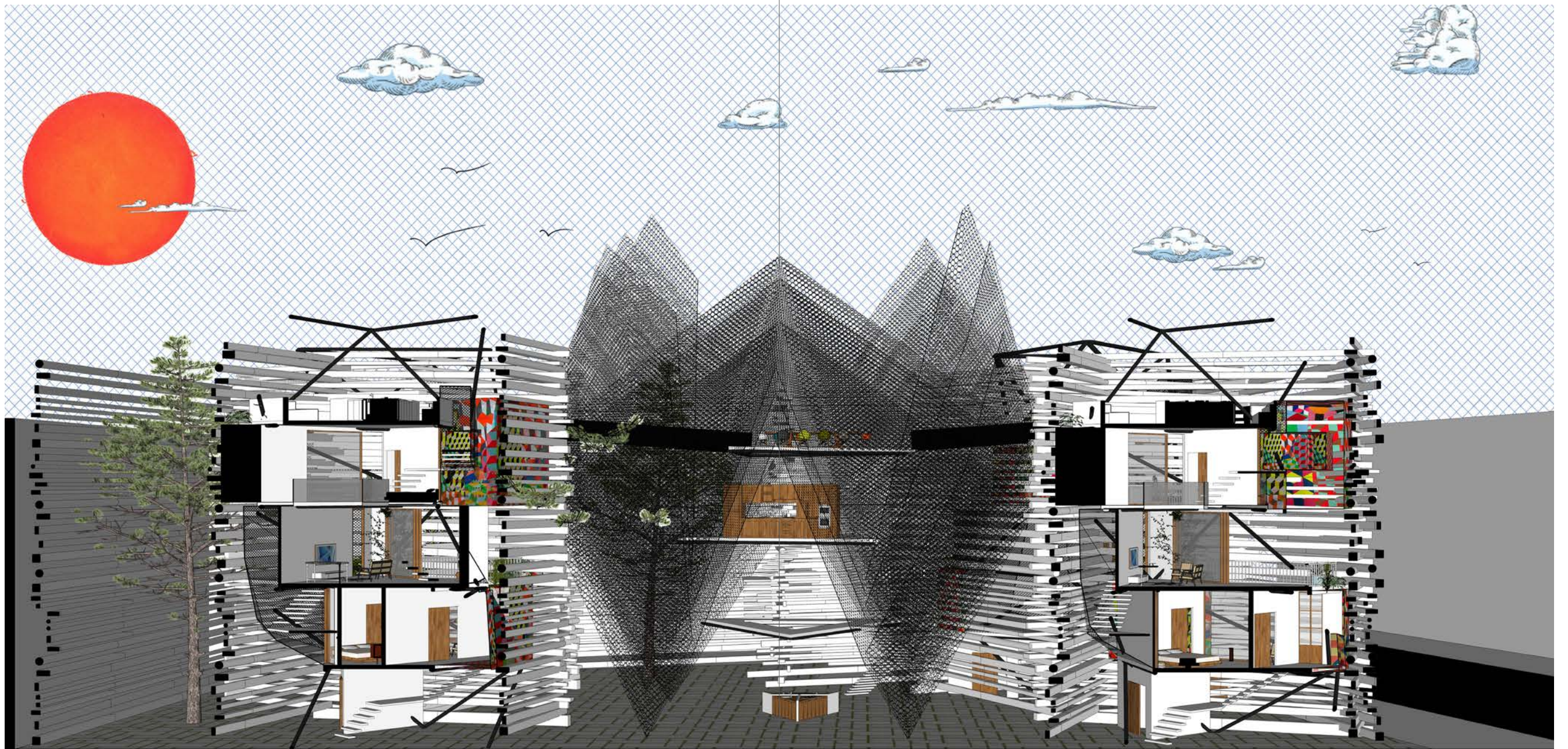

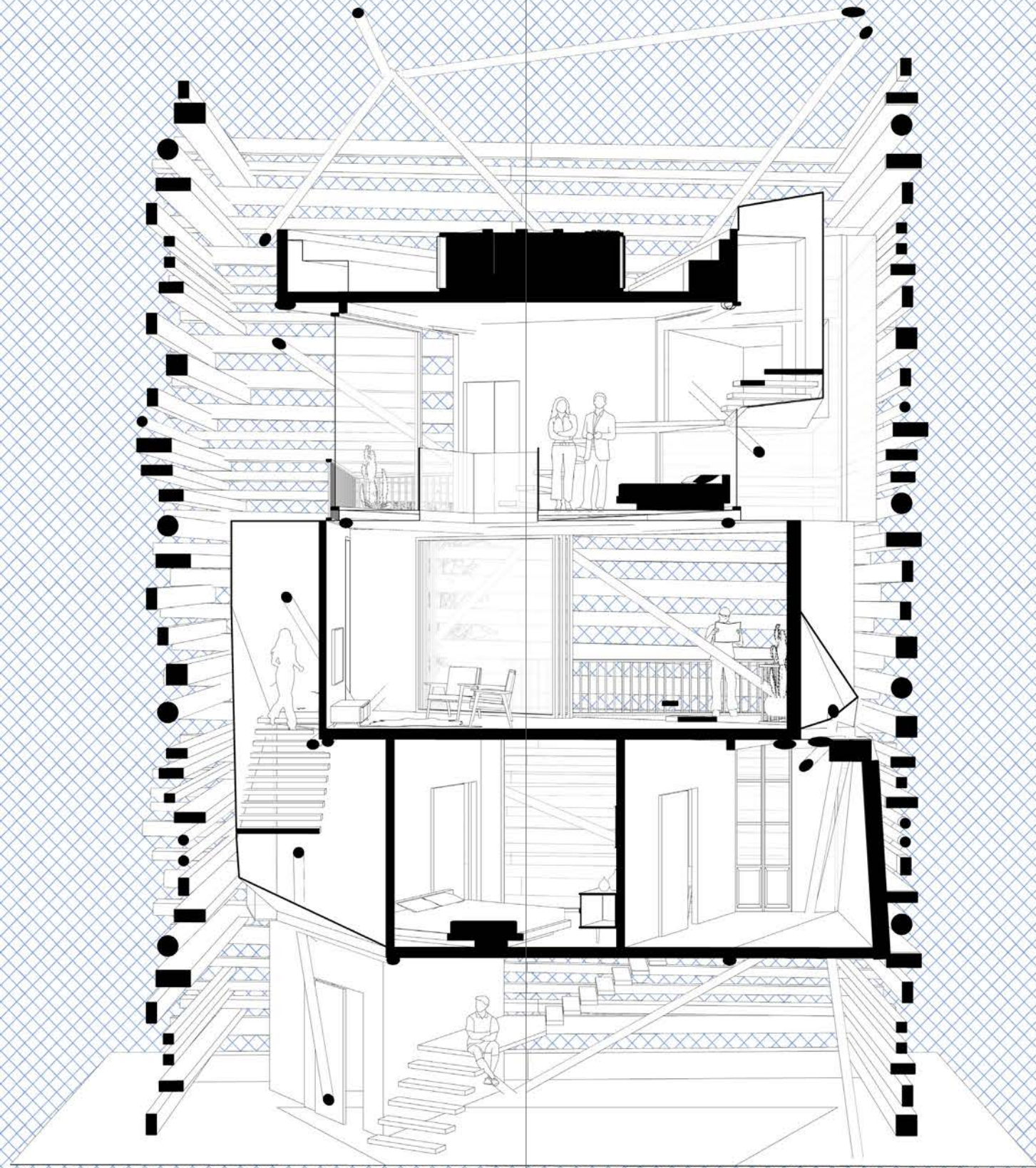



MI CASA ES TU CASA



TECHNIQUES OF THE ULTRA REAL

Prof. Joseph Brennan and Phillip Crupi
Team: Gahidaa Gutub
Christian Pineda

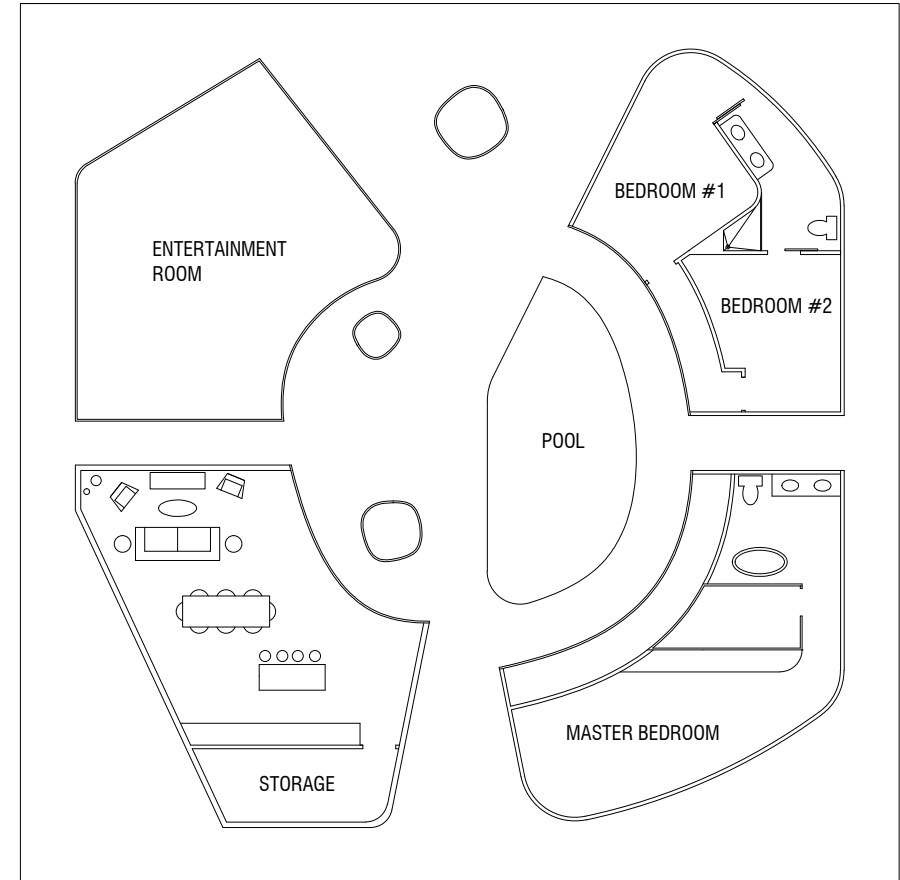
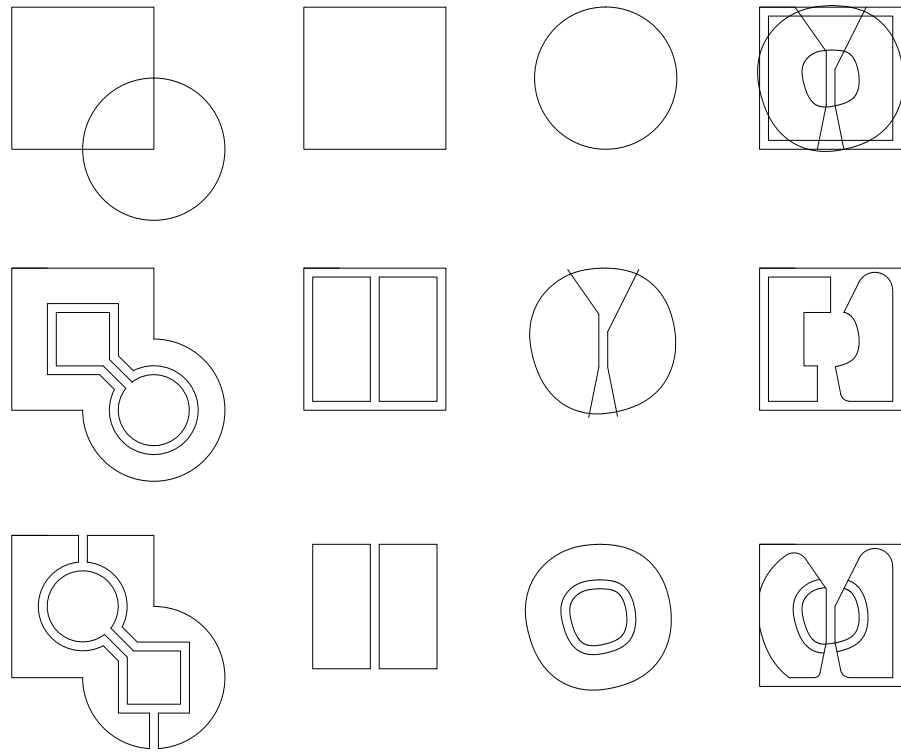



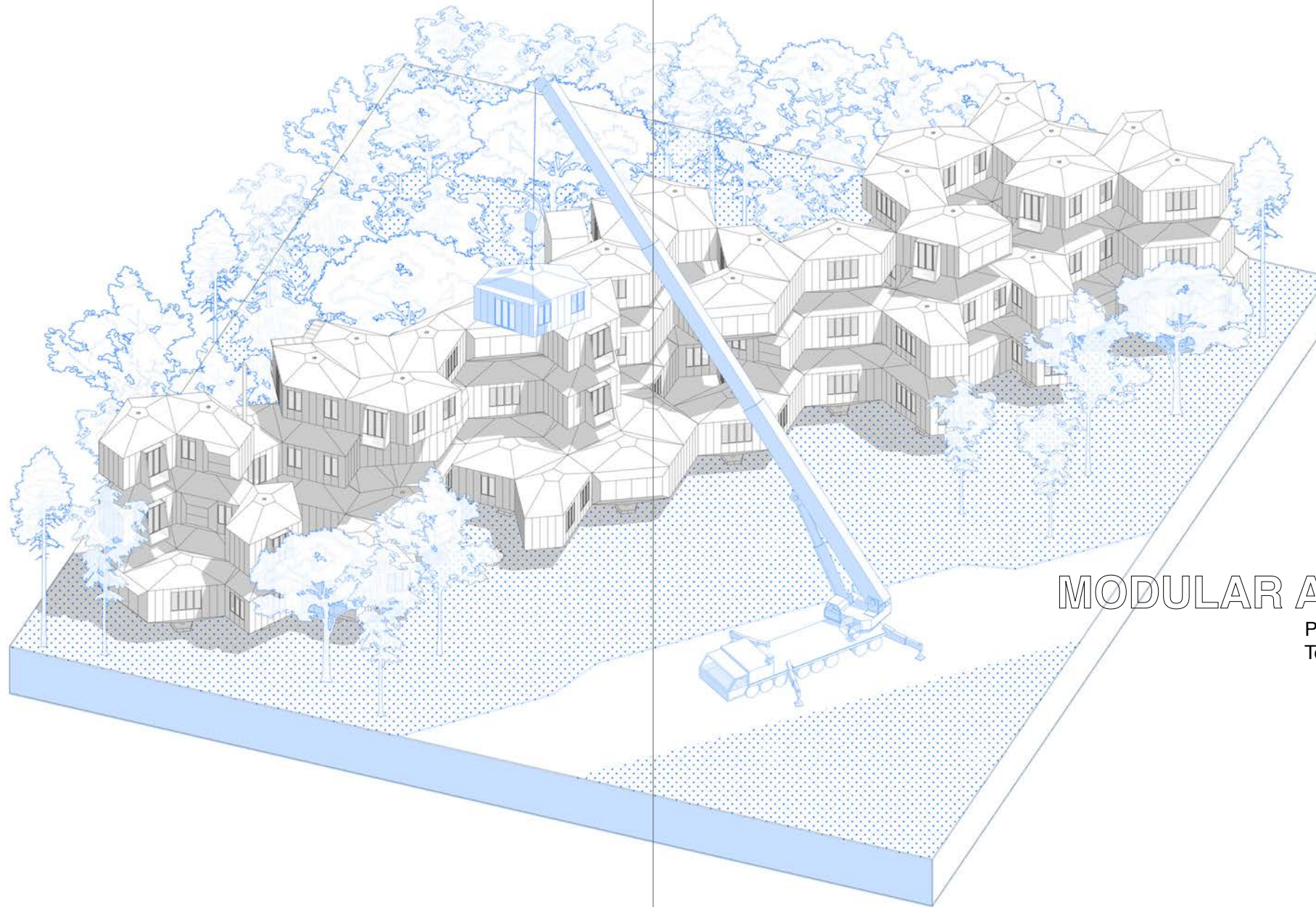

MODULAR ANATOMY

Prof. Andreas Tjeldflaat
Team: Benjamin Gomez
Oscar Mayorga
Christian Pineda

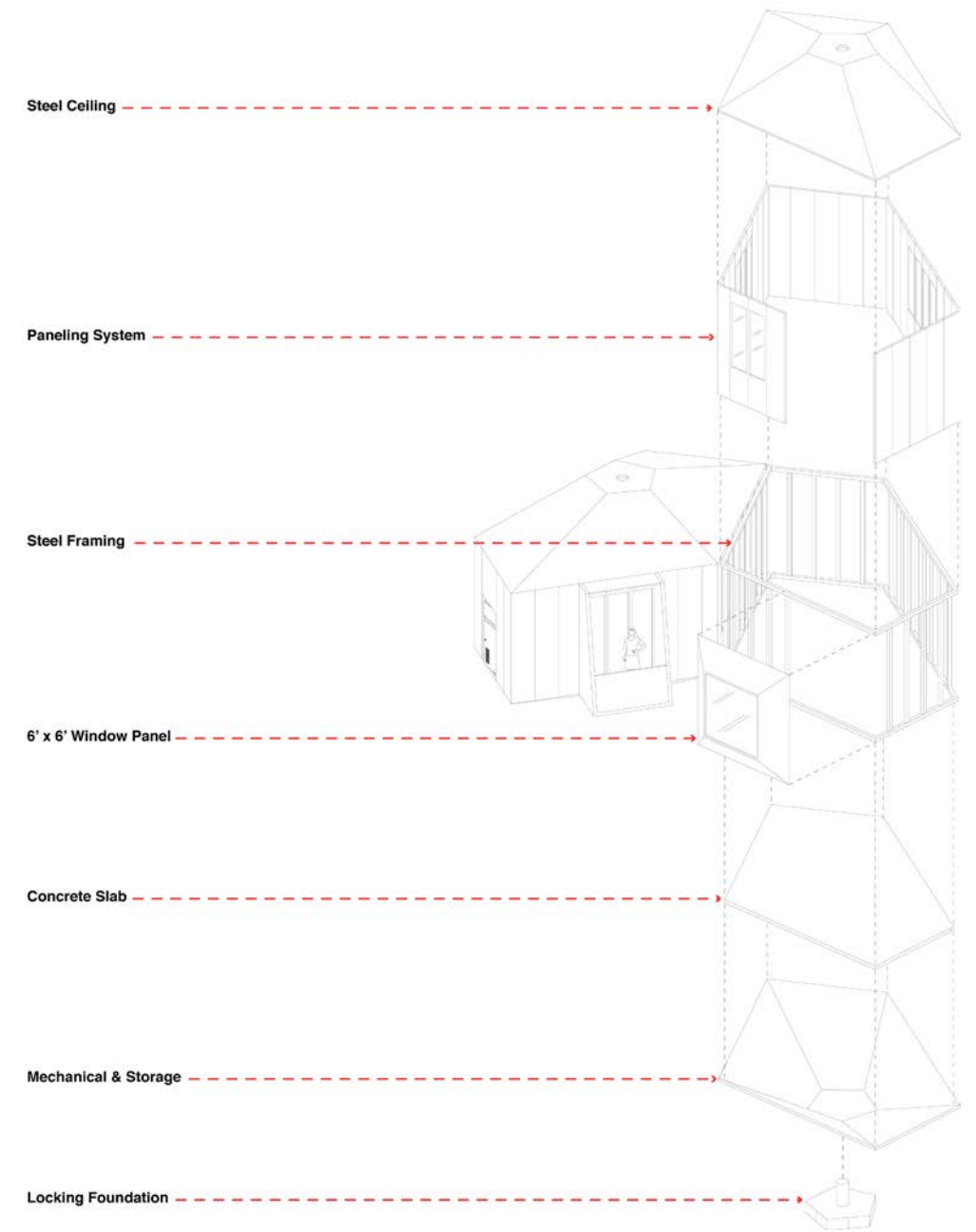
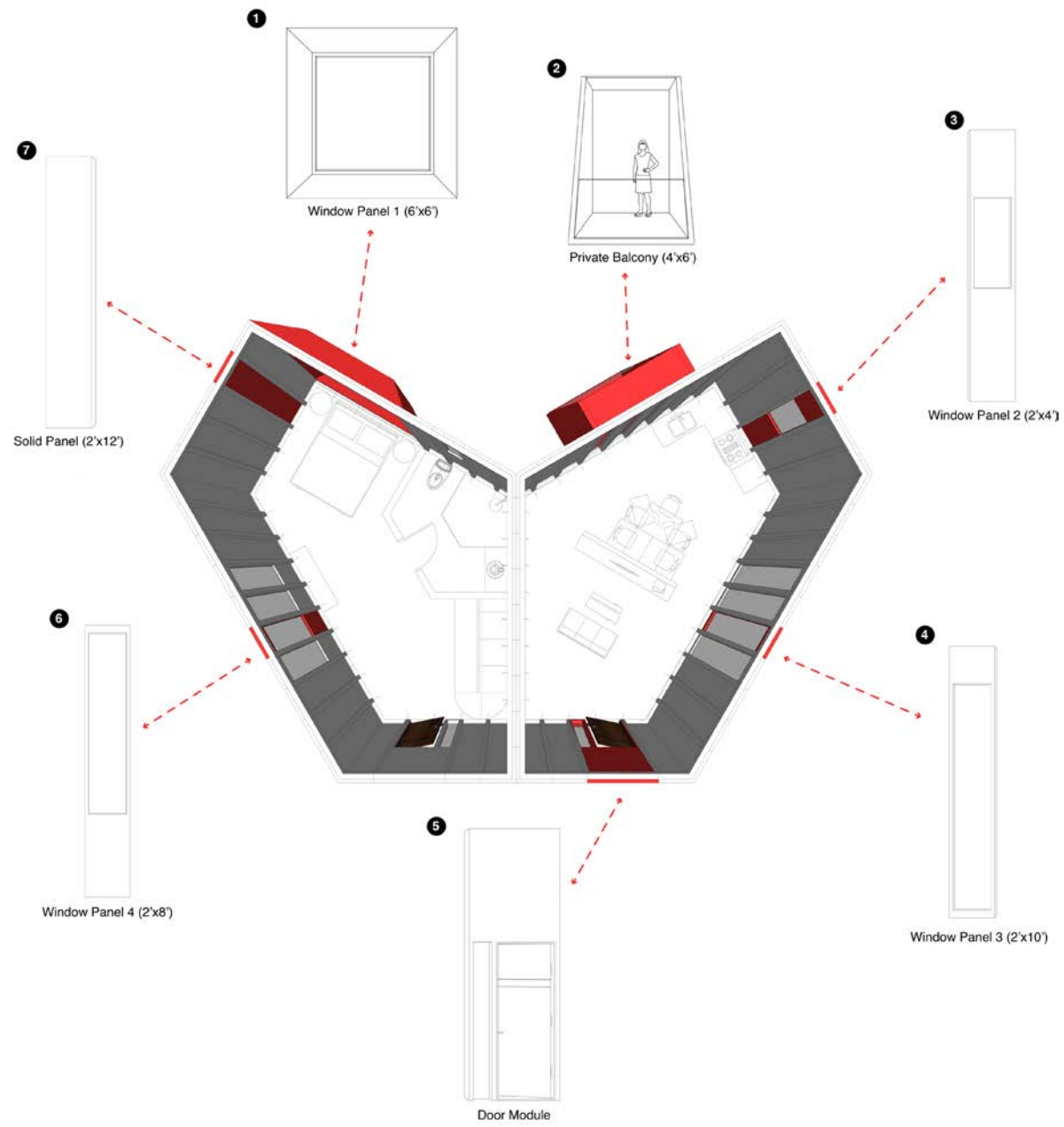

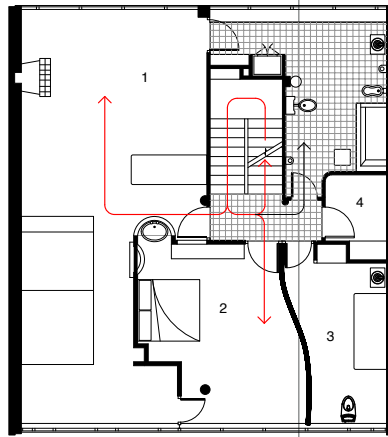
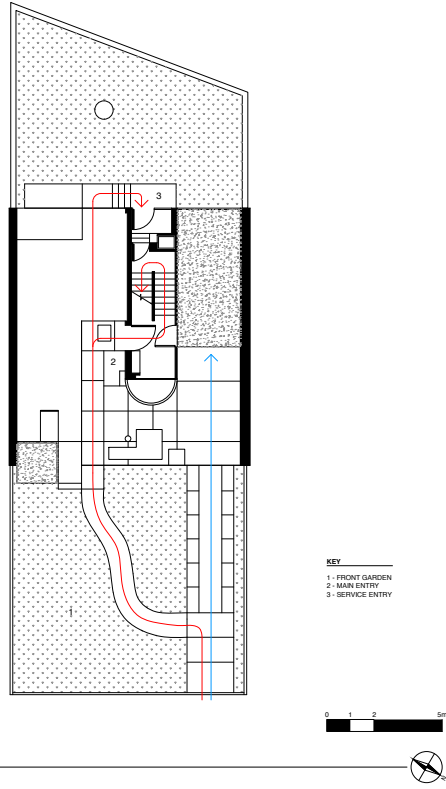

First Floor Plan

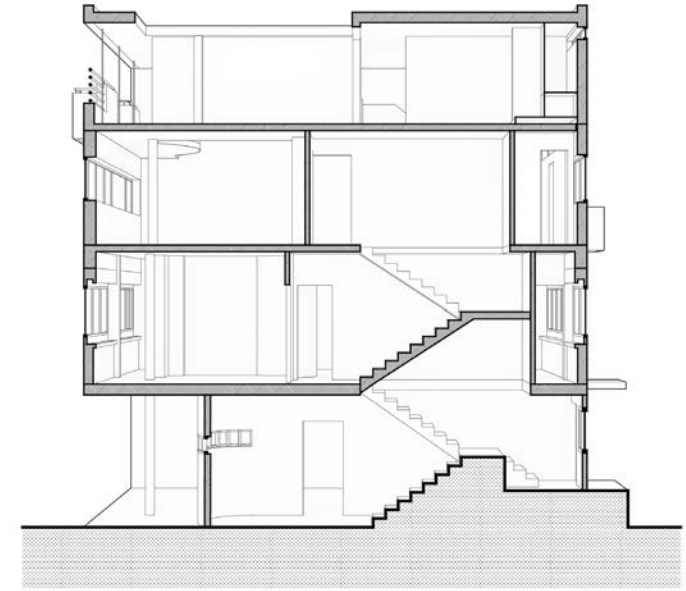

LE CORBUSIER

Prof. Kenneth Frampton
Team: Shengyang He
Christian Pineda

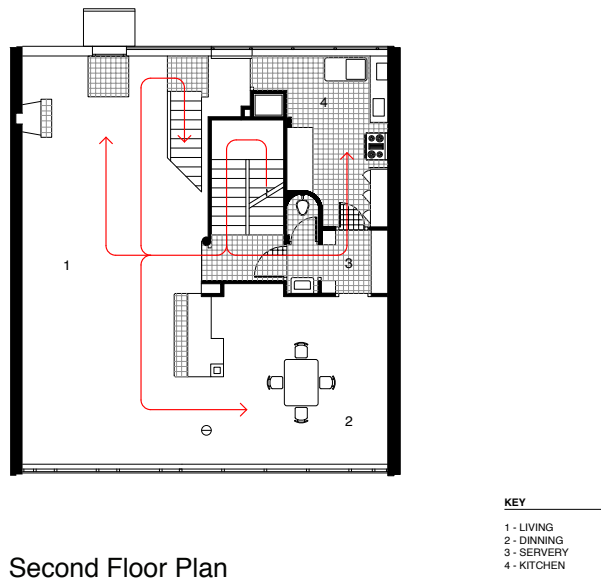

Second Floor Plan

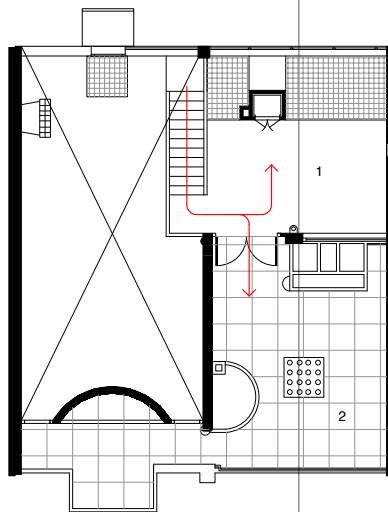

Third Floor Plan

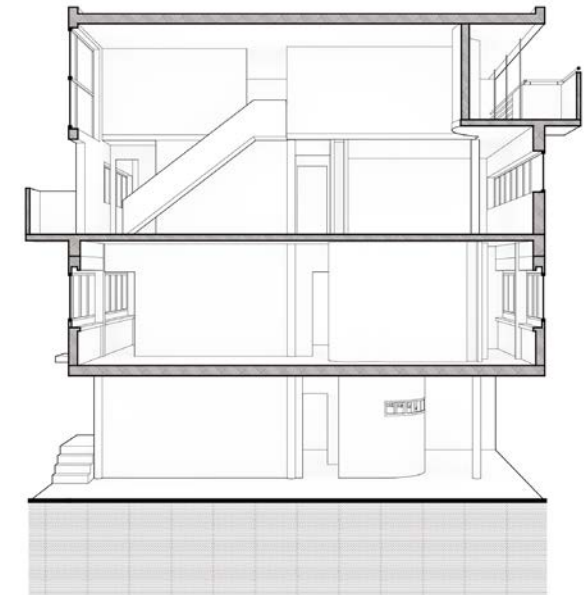

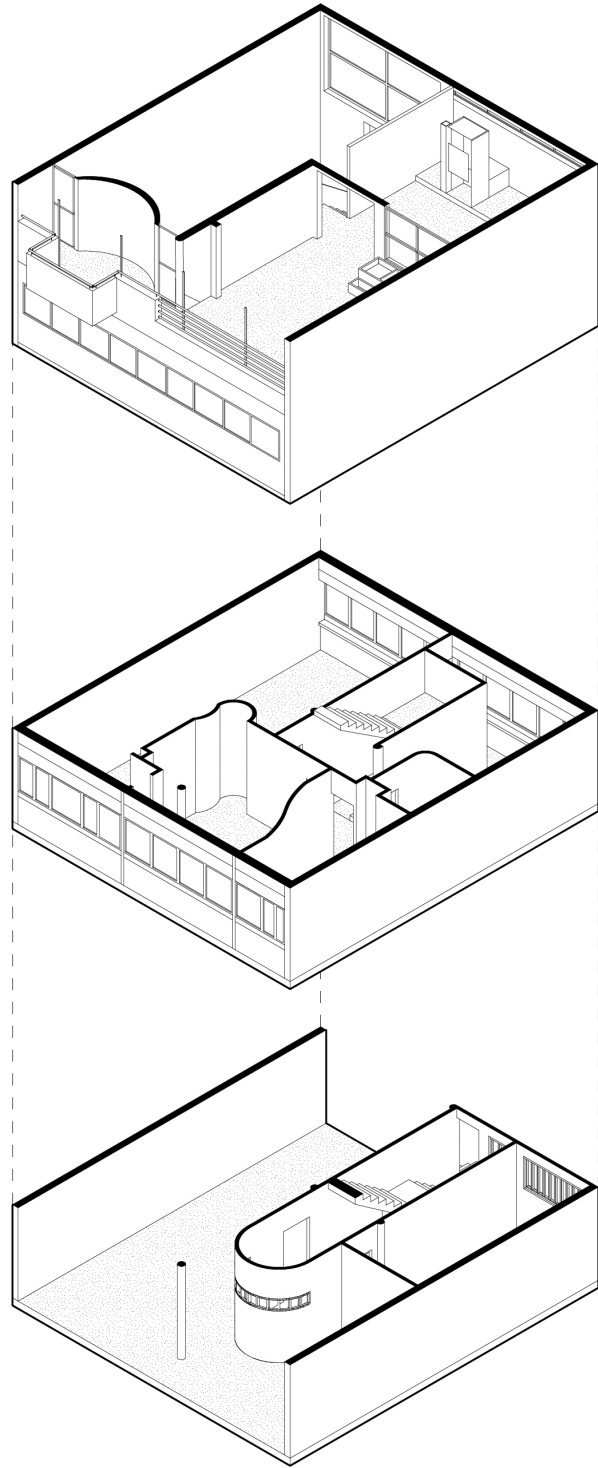

4F

3F

2F

1F

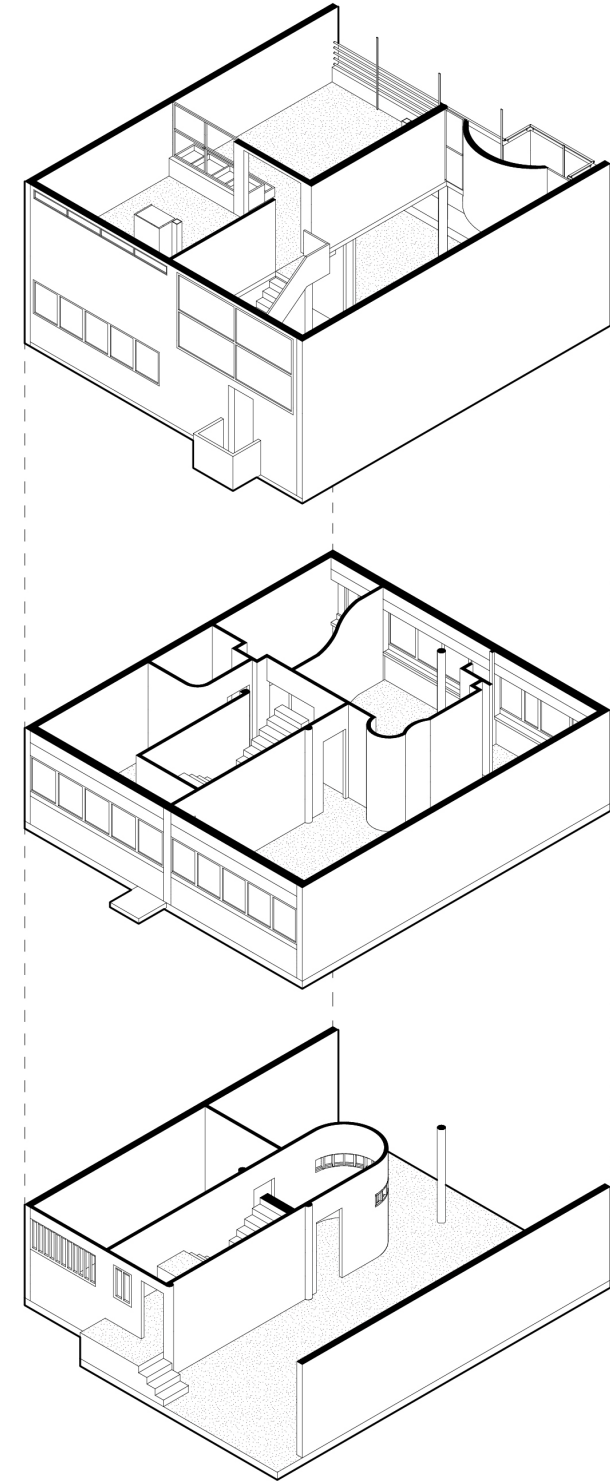

4F

3F

2F

1F

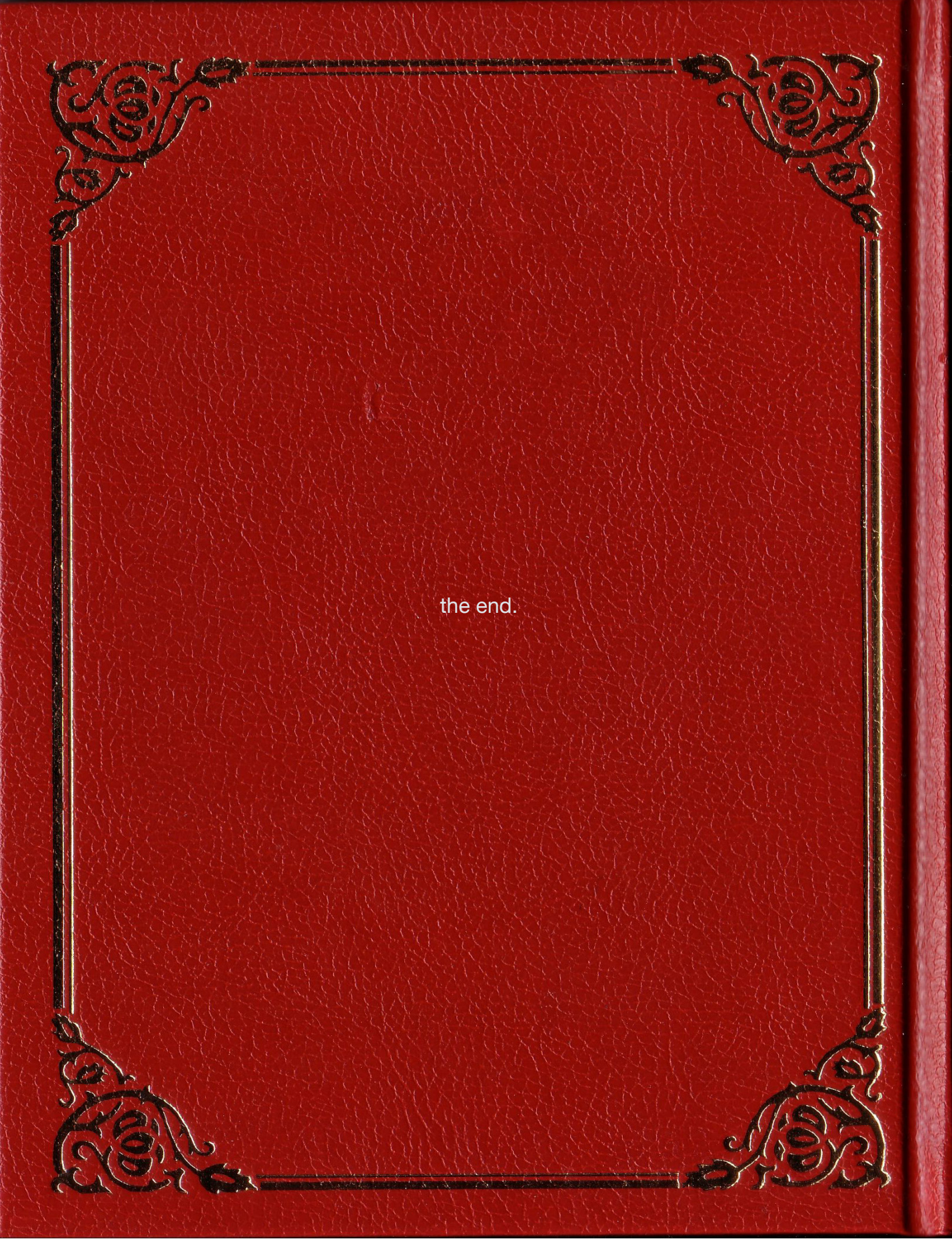
The image shows the front cover of a book. The cover is a deep red color with a pebbled, leather-like texture. A decorative gold border is embossed on the cover, consisting of a double-line rectangular frame with ornate, symmetrical scrollwork at each of the four corners. The text "the end." is printed in a simple, white, sans-serif font in the center of the cover.

the end.